

R. A. TOWNSEND COMPANY

DISTRIBUTOR OF PLUMBING, HEATING & AIR CONDITIONING PRODUCTS

PRODUCT CATALOG

www.ratownsend.com

ALPENA

1100 N. Bagley Street
Alpena, MI 49707
P: 800-440-6300
F: 800-356-7044

BURTON

4187 Somers Drive
Burton, MI 48529
P: 810-743-9000
F: 810-743-6828

SAGINAW SHOWROOM

2845 McCarty Road
Saginaw, MI 48603
Call for an appointment
P: 989-498-7000

WARREN

24051 Gibson Drive
Warren, MI 48089
P: 586-759-5559
F: 586-759-6860

Current Product Lines

PIPE, VALVES & FITTINGS

American Valve	Gastite
ASC	Halstead pipe insul.
- Anvil	IMCOA pipe insul.
- Gruvlok	Johns Manville
- Power-Strut	Legend Valves
Atco flex duct	PCD flat sheets
Basset	PCD spiral products
Black pipe & fittings	PVC pipe & fittings
Boshart	Red-White Valves
Copper pipe & fittings	Rehau
CPVC pipe & fittings	Sioux Chief
Fiberglass pipe insul.	Uponor
Galv. flat sheets	Watts
Galv. pipe & fittings	Zurn
Galv. spiral products	

PLUMBING

Aker	MAAX
Amtrol	Maidstone
Americast	Mansfield
Aptations	Metpar
BainUltra	Moen
Barclay	Mountain Plumbing
Basco	Mr. Steam
Bemis	Mustee
Bocchi	Native Trails
Brasscraft	Oatey
Brizo	Outdoor Shower
Carstin	Panasonic
Cordova	Premier Copper
Dearborn Brass	Prier
Delta	Roda
Elcoma	Sagehill
Electric Mirror	Schier
Elkay	Sloan
Fernco	Speakman
Franke	Sterling
Geberit	Stiebel Eltron
Gerber	Strasser
Health at Home	Strom Living
Hercules	Thermasol
Insinkerator	T&S Brass
Jason	Top Knobs
Jomar	Topp Industries
Kohler	Waterfall Euro Doors
Kraus	Wetwall
Little Giant	Woodford

HVAC & CONTROLS

Air filters	Furnace filters	Panasonic
Air rotation equipment	General Filters	Price
Allied Air Enterprises	Gibson	PRO1 (Diversitech)
- AirEase	Greenheck fans	Quick Sling
- Ducane	Hardcast	Rectorseal
- MagicPak	Hart & Cooley	Refrigerant
- Allied Commercial	HeatFab	Renewaire
- Allied Parts	Honeywell Home	Reznor
Aprilaire	ICM	Roberts-Gordon
Aspen	Linesets	Seal-Tite
Bard	Little Giant	Selkirk
Beckett	Malco	Southwire Company
Broan	Mammoth	Southwark
Cielo	Mars Motors	Supco
Combustion Research	Maytag	Supreme Stands
Comfort-Aire	Maxipro	Thermopan
Cover Guard	Miller	Thermostat wire
Diversitech	Multiaqua	Tjernlund
Durodyne	Nailor	Trion
Dynomate	Napoleon	UEi
Emerson	Nortek	Unico
Empire	- Gibson	U.S. Motors (Nidec)
EWC	- Mammoth	Copeland (formerly White-Rodgers)
EZ Aire (Munters)	- Maytag	Yellow Jacket
Fantech	- Miller	
Field	- Reznor	

HYDRONICS

Amtrol	Magic-Aire	Stiebel Eltron
A. O. Smith	McDonnell-Miller	Taco
Beacon/Morris	Modine	Tekmar
Bell & Gossett	Noble	Trane
Conbraco (APC)	Raypak	Triangle
Danfoss	Rheem	Webstone
Grundfos	Rhomar	Weil-McLain
Hoffman Specialties	Rinnai	Wilkins
Hydrolevel	Slant/Fin	
Lochinvar	Sparco	

(Eff 9/17/2024)

ALPENA BRANCH

1100 N. Bagley Street
Alpena, MI 49707
P: 800-440-6300
F: 800-356-7044

BURTON BRANCH

4187 Somers Drive
Burton, MI 48529
P: 810-743-9000
F: 810-743-6828

SAGINAW SHOWROOM

2845 McCarty Road
Saginaw, MI 48603
Call for an appointment
P: 989-498-7000

WARREN BRANCH

24051 Gibson Drive
Warren, MI 48089
P: 586-759-5559
F: 586-759-6860

100 SECTION

Pipe — Valves — Fittings

100 SECTION INDEX

American Valve	112	Safe-Waste	116.1
Anvil (ASC)	102-102.10 (also see 700 section)	Schedule 30/40 Pipe and Fittings	108-108.4
Boshart	see 400 section	Schier	124
Brasscraft	111-111.2 (also see 200 section)	Sewer & Drain Fittings	108.5
Fernco	117	Sioux Chief	106.1-106.4, 116-116.2, 119 (also see 700 section)
Gastite	100-100.4	Speedline	122
Gruvlok (ASC)	113	Threaded Rod	see 700 section
IMCOA	120	Uponor (Wirsbo)	see 400 section
Jones-Stephens	106, 113, 125 (also see 700 section)	Waterless Trap Primer	118
Knauf	121	Well Tanks	see 400 Section
Legend	105-105.13	Wheatland	101
Matco-Norca	102.7	Woodford	114-114.1
Maxipro	104-104.1	Vinyl Tubing & Accessories	125
Nipple Trays	see 700 section	Zurn	115 (also see 200 section)
No-Hub Couplings	105.12		
Non-barrier PEX Pipe	106		
Oatey	117 (also see 300, 400 and 700 sections)		
Plumberex	123		
Plumbing Specialties	116-116.2		
Prier	113 (also see 200 section)		
PVC Pressure Fittings/Accessories	108.6, 109		
Rehau	see 400 section		

GASTITE FLASHSHIELD+ CSST PIPING



- Corrugated stainless steel tubing (CSST) protected by a metallic laminant jacket system
- Jacket system consists of a metallic shield layer between an electrically insulative polymer cover and a semi-conductive polymer inner layer
- Protective shield is electrically continuous through fitting joints
- No manufacturer-required bonding
- Installs 30%-70% faster than traditional piping methods
- Pre-marked by the foot
- Lightweight and flexible
- -40°F to 160°F operating temperature range
- Complies with ANSI LC 1 "Fuel Gas Piping Systems Using CSST"
- Listed to the Arc Resistant (AR) test of ANSI LC1/CSA 6.26 and ICC-ES PMG LC1027



ID ORDER#	MODEL #	CSST SIZE	NOM. O.D. (without jacket)	NOM. O.D. (with jacket)	SS WALL THICKNESS	MAX. TEST PRESSURE (PSI)
738793	FSP-8-50	1/2" x 50'	0.72	0.78	0.01"	150
738795	FSP-8-250	1/2" x 250'	0.72	0.78	0.01"	150
738796	FSP-11-50	3/4" x 50'	0.92	1.00	0.01"	150
738798	FSP-11-250	3/4" x 250'	0.92	1.00	0.01"	150
738807	FSP-16-75	1" x 75'	1.26	1.33	0.01"	125
738808	FSP-16-150	1" x 150'	1.26	1.33	0.01"	125
742518	FSP-20-150	1-1/4" x 150'	1.50	1.57	0.01"	100

ACCESSORIES

658582	GTCUTTER-LG2	CSST TUBE CUTTER , for up to 2" CSST pipe
456619	GTCUTTER-SM2	Same as above, but for 3/8" to 1" CSST pipe
748566	STRP4-8-11	JACKET STRIPPER , for 1/2" and 3/4" CSST pipe
748567	STRP4-16-20	Same as above, but for 1" and 1-1/4" CSST pipe

FOR ADDITIONAL INFORMATION, SEE THE GASTITE WEBSITE AT www.gastite.com

INSTALLATION REQUIREMENTS

- 1) Installation must be performed strictly in accordance with local plumbing and/or building codes, and in accordance with Flashshield/Flashshield+ Design and Installation Guide.
- 2) **Installation must be performed by an installer who has successfully completed a training program recognized by Gastite Division and has been issued a Certification Card.** Certifications are available through qualified distributors, and at www.gastite.com.
- 3) Pressure testing must be performed during rough construction with piping system exposed.
- 4) Gastite Division assumes no responsibility for product or labor for any system which has been improperly installed.

GASTITE

FLASHSHIELD+ CSST FITTINGS



ID ORDER#	MODEL #	DESCRIPTION
--------------	---------	-------------

APPLIANCE STUB-OUTS



683147	XR3-APSTUB-8-10	APPLIANCE STUB OUT , 1/2" M x 1/2" M x 1-1/2" stub length with 1/2" female fitting, 10/box
683148	XR3-APSTUB-11-10	Same as above, but with 3/4" female fitting

CONDUITS



175386	LFLOPPY-16-50	CONDUIT—STEEL , 1", cut to 1 foot length, fits 1/2" CSST, 50/box
175388	LFLOPPY-20-25	Same as above, but 1-1/4" and fits 3/4" CSST, 25/box

COUPLINGS



683140	XR3CPL-8-12	COUPLING , 1/2", 12/box
683141	XR3CPL-11-12	Same as above, but 3/4"
683142	XR3CPL-16-6	Same as above, but 1" and 6/box

FITTINGS—STRAIGHT



683045	XR3FTG-8-24	FITTING—STRAIGHT , 1/2" NPT, 24/box
683046	XR3FTG-11-24	Same as above, but 3/4" NPT
683047	XR3FTG-16-12	Same as above, but 1" NPT and 12/box
670051	XR3FTG-20-6	Same as above, but 1-1/4" NPT and 6/box

FITTINGS—TERMINAL, SQUARE FLANGE



683130	XR3TRM-8-12	FITTING—TERMINAL, SQUARE FLANGE , 1/2" NPT, includes flange, adapter, nut and bushing, 12/box
683133	XR3TRM-11-12	Same as above, but 3/4" NPT
683134	XR3TRM-16-6	Same as above, but 1" and 6/box

STRIKER PLATES



175383	TFM204-100	STRIKER PLATE—QUARTER , 3" x 2", 100/box
175384	TFM201-50	Same as above, but HALF (3" x 7") and 50/box
175385	TFM205-25	Same as above, but FULL (3" x 12") and 25/box

FOR ADDITIONAL INFORMATION, SEE THE GASTITE WEBSITE AT www.gastite.com

GASTITE

CSST FLEXIBLE GAS PIPING SPECIFICATIONS



NATURAL GAS - CSST CAPACITY TABLES

Maximum capacity of Gastite® flexible gas piping in cubic feet per hour of natural gas with **gas pressure of 0.5 psi or less and a pressure drop of 0.5 in. WC** (based on a 0.60 specific gravity gas)

TUBING LENGTH (FT.)

Size	5'	10'	15'	20'	25'	30'	40'	50'	60'	70'	80'	90'	100'	125'	150'	200'	250'	300'	400'	500'
3/8"	47	32	26	22	20	18	15	14	13	12	11	10	10	8	8	7	6	5	5	4
1/2"	131	93	76	66	59	54	47	42	38	36	33	32	30	27	24	21	19	17	15	14
3/4"	251	183	152	133	120	110	97	87	80	75	70	67	63	57	53	46	42	38	34	30
1"	578	415	341	297	267	244	213	191	175	163	153	144	137	123	113	98	88	81	70	63
1-1/4"	871	620	508	441	396	362	314	282	258	239	224	211	201	180	164	143	128	117	102	91

PROPANE TABLE

Maximum capacity of Gastite® flexible gas piping in thousands of BTU per hour of liquefied petroleum gas with a **gas pressure of 0.5 psi or less and a pressure drop of 0.5 in. WC** (based on a 1.52 specific gravity LP gas)

TUBING LENGTH (FT.)

Size	5'	10'	15'	20'	25'	30'	40'	50'	60'	70'	80'	90'	100'	125'	150'	200'	250'	300'	400'	500'
3/8"	74	51	41	35	31	29	25	22	20	18	17	16	15	13	12	10	9	8	7	6
1/2"	208	148	121	105	94	86	75	67	61	57	53	50	47	42	39	34	30	28	24	21
3/4"	398	290	240	211	190	175	153	138	127	118	111	106	101	91	83	73	66	61	53	48
1"	917	657	541	471	423	387	337	303	278	258	242	229	217	195	179	156	140	128	112	100
1-1/4"	1381	983	806	700	627	574	498	446	408	379	355	335	318	285	261	226	203	185	161	144

GASTITE UNDERGROUND IPS TUBING



- Polyethylene gas piping system specifically engineered and certified for the underground environment
- Uses Con-Stab I.D. Seal
- Simple assembly
- No additional assembly equipment required for installation—just chamfer and push
- Uni-body design eliminating all external parts
- Designed, tested and certified for direct burial
- Eliminates corrosive threats associated with metallic piping
- Continuous lengths of flexible piping
- Meets code/specifications of NFPA-58 and NFPA-54, ASTM D-2513 (Category 1), ASME D-B31.8-1995, CAN/CSA-B137.4, US DOT Part 192.283, ISO 4437
- Listed with CSA and IAPMO/UPC



ID ORDER#	MODEL #	IPS SIZE	NOM. I.D.	NOM. O.D.
714641	PE-12-125	3/4" IPS SDR 11 x 125' coil	24"	35"
197641	PE-12-250	3/4" IPS SDR 11 x 250' coil	30"	50"
714642	PE-16-125-IPS	1" IPS SDR 11 x 125' coil	25"	34"
231731	PE-16-250-IPS	1" IPS SDR 11 x 250' coil	30"	45"
714646	PE-20-125	1-1/4" IPS SDR 10 x 125' coil	48"	58"
181670	PE-20-250	1-1/4" IPS SDR 10 x 250' coil	48"	64"



ACCESSORIES

562649	CHTOOL-12-16IPS	CHAMFER TOOL , for 3/4" and 1" IPS tubing
562650	CHTOOL-20	Same as above, but for 1-1/4" IPS tubing
181674	MAG-TAPE	MAGNETIC TAPE , 2" x 1000' roll

FOR ADDITIONAL INFORMATION, SEE THE GASTITE WEBSITE AT www.gastite.com

GASTITE UNDERGROUND IPS FITTINGS



	ID ORDER#	MODEL #	DESCRIPTION
COUPLINGS			
	192325	PECPL-12	COUPLING , 3/4" IPS SDR 11
	246619	PECPL-16-IPS	<i>Same as above</i> , but 1" IPS
	192327	PECPL-20	<i>Same as above</i> , but 1-1/4" IPS and SDR 10
RISERS			
	192323	RISER-12-30	RISER WITH CON-STAB COUPLING , 3/4" IPS SDR 11 x 30" bury depth x 3/4" NPT
	214657	RISER-16-30-IPS	<i>Same as above</i> , but 1" IPS and 1" NPT
	181671	RISER-20-30	<i>Same as above</i> , but 1-1/4" IPS SDR 10 and 1-1/4" NPT
TRANSITION FITTINGS			
	212933	TRANS-12	TRANSITION FITTING , 3/4" IPS x 3/4" NPT
	218268	TRANS-16-IPS	<i>Same as above</i> , but 1" IPS x 1" NPT
	615545	TRANS-20	<i>Same as above</i> , but 1-1/4" IPS x 1-1/4" NPT

FOR ADDITIONAL INFORMATION, SEE THE GASTITE WEBSITE AT www.gastite.com

WHEATLAND STEEL & GALVANIZED PIPE



BLACK STEEL PIPE

Schedule 40, 21' Length, Threaded & Coupled (T & C), Continuous Weld (CBW), A-53/A-120

ID ORDER#	SIZE	LENGTHS PER BUNDLE	FEET PER BUNDLE
Note: Priced per 100'			
1940	1/2"	127	2667
1942	3/4"	91	1911
1947	1"	70	1470
1966	1-1/4"	51	1071
1972	1-1/2"	44	924
1979	2"	30	630
1984	2-1/2"	20	420
1985	3"	13	273
1986	4"	10	210

BLACK STEEL PIPE

Schedule 40, 10' Length, Threaded Only, (TO), Continuous Weld, (CBW), A-53/A-120

50381	1/2"	130	1300
52165	3/4"	100	1000
52166	1"	65	650
443795	1-1/4"	50	500

GALVANIZED STEEL PIPE

Schedule 40, 21' Length, Threaded & Coupled (T&C), Continuous Weld (CBW), A-53/A-120

21564	1/2"	127	2667
21563	3/4"	91	1911
21059	1"	70	1470
21565	1-1/4"	51	1071
27216	1-1/2"	44	924
22508	2"	30	630

FOR THREADED ROD, SEE 700 SECTION

IMPORTANT NOTES:

According to the 2000 International Fuel Gas Code® Section #403.9, "metallic pipe and fitting threads shall be taper pipe threads and shall comply with ASME B1.20.1." Most standard pipe couplings are made in accordance with the ASTM A865 specifications. However, the couplings on certain sizes of pipe may have straight heads and thus may not comply with the 2000 International Fuel Gas Code®.

ANVIL (ASC)

BLACK THREADED NIPPLES

SCHEDULE 40



ID ORDER#	SIZE	CTN QTY	ID ORDER#	SIZE	CTN QTY
2810	1/8" x close	25	2857	3/4" x close	25
2811	1/8" x 1-1/2"	25	2858	3/4" x 1-1/2"	25
2812	1/8" x 2"	25	2859	3/4" x 2"	25
2813	1/8" x 2-1/2"	25	2860	3/4" x 2-1/2"	25
2814	1/8" x 3"	25	2861	3/4" x 3"	25
2815	1/8" x 3-1/2"	25	2862	3/4" x 3-1/2"	25
2816	1/8" x 4"	25	2863	3/4" x 4"	25
2817	1/8" x 4-1/2"	25	2864	3/4" x 4-1/2"	25
2818	1/8" x 5"	25	2865	3/4" x 5"	25
2819	1/8" x 5-1/2"	25	2866	3/4" x 5-1/2"	25
2820	1/8" x 6"	25	2867	3/4" x 6"	25
			2868	3/4" x 8"	25
2821	1/4" x close	25	2869	3/4" x 10"	25
2822	1/4" x 1-1/2"	25	2870	3/4" x 12"	25
2823	1/4" x 2"	25			
2824	1/4" x 2-1/2"	25	2872	1" x close	25
2825	1/4" x 3"	25	2873	1" x 2"	25
2826	1/4" x 3-1/2"	25	2874	1" x 2-1/2"	25
2827	1/4" x 4"	25	2875	1" x 3"	25
2828	1/4" x 4-1/2"	25	2876	1" x 3-1/2"	25
2829	1/4" x 5"	25	2877	1" x 4"	25
2830	1/4" x 5-1/2"	25	2878	1" x 4-1/2"	25
2831	1/4" x 6"	25	2879	1" x 5"	25
			2880	1" x 5-1/2"	25
2832	3/8" x close	25	2881	1" x 6"	25
2833	3/8" x 1-1/2"	25	2882	1" x 8"	25
2834	3/8" x 2"	25	2883	1" x 10"	20
2835	3/8" x 2-1/2"	25	2884	1" x 12"	20
2836	3/8" x 3"	25			
2837	3/8" x 3-1/2"	25	2886	1-1/4" x close	25
2838	3/8" x 4"	25	2887	1-1/4" x 2"	25
2839	3/8" x 4-1/2"	25	2888	1-1/4" x 2-1/2"	25
2840	3/8" x 5"	25	2889	1-1/4" x 3"	25
2841	3/8" x 5-1/2"	25	2890	1-1/4" x 3-1/2"	25
2842	3/8" x 6"	25	2891	1-1/4" x 4"	25
			2892	1-1/4" x 4-1/2"	25
2843	1/2" x close	25	2893	1-1/4" x 5"	25
2844	1/2" x 1-1/2"	25	2894	1-1/4" x 5-1/2"	25
2845	1/2" x 2"	25	2895	1-1/4" x 6"	25
2846	1/2" x 2-1/2"	25	2896	1-1/4" x 8"	15
2847	1/2" x 3"	25	2897	1-1/4" x 10"	30
2848	1/2" x 3-1/2"	25			
2849	1/2" x 4"	25			
2850	1/2" x 4-1/2"	25			
2851	1/2" x 5"	25			
2852	1/2" x 5-1/2"	25			
2853	1/2" x 6"	25			
738428	1/2" x 7"	25			
2854	1/2" x 8"	25			
2855	1/2" x 10"	25			
2856	1/2" x 12"	25			

**FOR ADDITIONAL INFORMATION, VISIT
THE ANVIL (ASC) WEBSITE AT: www.asc-es.com**

ANVIL (ASC)

BLACK THREADED NIPPLES SCHEDULE 40



ID ORDER#	SIZE	CTN QTY	ID ORDER#	SIZE	CTN QTY
2898	1-1/2" x close	25	BLACK ASSORTED NIPPLES — BOXED		
2899	1-1/2" x 2"	25	2967	1/2"	66
2900	1-1/2" x 2-1/2"	25	2969	3/4"	66
2901	1-1/2" x 3"	25	2971	1"	60
2902	1-1/2" x 3-1/2"	25	FOR ADDITIONAL INFORMATION, VISIT THE ANVIL (ASC) WEBSITE AT: www.asc-es.com		
2903	1-1/2" x 4"	25			
2904	1-1/2" x 4-1/2"	25			
2905	1-1/2" x 5"	20			
2906	1-1/2" x 5-1/2"	20			
2907	1-1/2" x 6"	20			
2908	1-1/2" x 8"	25			
2909	1-1/2" x 10"	15			
2910	1-1/2" x 12"	15			
2912	2" x close	25			
2913	2" x 2-1/2"	25			
2914	2" x 3"	50			
2915	2" x 3-1/2"	25			
2916	2" x 4"	25			
2917	2" x 4-1/2"	25			
2918	2" x 5"	25			
2919	2" x 5-1/2"	25			
2920	2" x 6"	25			
2921	2" x 8"	18			
2924	2-1/2" x close	36	FOR ADDITIONAL INFORMATION, VISIT THE ANVIL (ASC) WEBSITE AT: www.asc-es.com		
2925	2-1/2" x 3"	36			
2926	2-1/2" x 3-1/2"	27			
2927	2-1/2" x 4"	27			
2928	2-1/2" x 5"	18			
2929	2-1/2" x 6"	18			
2930	2-1/2" x 8"	12			
2937	3" x close	24			
2939	3" x 3"	24			
2943	3" x 3-1/2"	18			
2947	3" x 4"	18			
2950	3" x 4-1/2"	16			
2951	3" x 5"	12			
2952	3" x 6"	12			
2958	4" x close	15	FOR ADDITIONAL INFORMATION, VISIT THE ANVIL (ASC) WEBSITE AT: www.asc-es.com		
2959	4" x 4"	12			
2960	4" x 5"	8			
2961	4" x 6"	8			
2962 *	4" x 8"	5			
2966 *	4" x 16"	2			

* = SPECIAL ORDER ITEM

ANVIL (ASC)

GALVANIZED THREADED NIPPLES

SCHEDULE 40



ID ORDER#	SIZE	CTN QTY	ID ORDER#	SIZE	CTN QTY
2975	1/8" x close	25	3021	3/4" x close	25
2976	1/8" x 1-1/2"	25	3022	3/4" x 1-1/2"	25
2977	1/8" x 2"	25	3023	3/4" x 2"	25
2978	1/8" x 2-1/2"	25	3024	3/4" x 2-1/2"	25
2979	1/8" x 3"	25	3025	3/4" x 3"	25
2980	1/8" x 3-1/2"	25	3026	3/4" x 3-1/2"	25
2981	1/8" x 4"	25	3027	3/4" x 4"	25
2982	1/8" x 4-1/2"	25	3028	3/4" x 4-1/2"	25
2983	1/8" x 5"	25	3029	3/4" x 5"	25
2984	1/8" x 5-1/2"	25	3030	3/4" x 5-1/2"	25
2985	1/8" x 6"	25	3031	3/4" x 6"	25
			232322 *	3/4" x 8"	25
2986	1/4" x close	25			
2987	1/4" x 1-1/2"	25	3032	1" x close	25
2988	1/4" x 2"	25	3033	1" x 2"	25
2989	1/4" x 2-1/2"	25	3034	1" x 2-1/2"	25
2990	1/4" x 3"	25	3035	1" x 3"	25
2991	1/4" x 3-1/2"	25	3036	1" x 3-1/2"	25
2992	1/4" x 4"	25	3037	1" x 4"	25
2993	1/4" x 4-1/2"	25	3038	1" x 4-1/2"	25
2994	1/4" x 5"	25	3039	1" x 5"	25
2996	1/4" x 5-1/2"	25	3040	1" x 5-1/2"	25
2997	1/4" x 6"	25	3041	1" x 6"	25
2998	3/8" x close	25	3043	1-1/4" x close	25
2999	3/8" x 1-1/2"	25	3044	1-1/4" x 2"	25
3000	3/8" x 2"	25	3045	1-1/4" x 2-1/2"	25
3001	3/8" x 2-1/2"	25	3046	1-1/4" x 3"	25
3002	3/8" x 3"	25	3047	1-1/4" x 3-1/2"	25
3003	3/8" x 3-1/2"	25	3048	1-1/4" x 4"	25
3004	3/8" x 4"	25	3049	1-1/4" x 4-1/2"	25
3005	3/8" x 4-1/2"	25	3050	1-1/4" x 5"	25
3006	3/8" x 5"	25	3051	1-1/4" x 5-1/2"	25
3008	3/8" x 5-1/2"	25	3052	1-1/4" x 6"	25
3009	3/8" x 6"	25			
			3053	1-1/2" x close	25
3010	1/2" x close	25	3054	1-1/2" x 2"	25
3011	1/2" x 1-1/2"	25	3055	1-1/2" x 2-1/2"	25
3012	1/2" x 2"	25	3056	1-1/2" x 3"	25
3013	1/2" x 2-1/2"	25	3057	1-1/2" x 3-1/2"	25
3014	1/2" x 3"	25	3058	1-1/2" x 4"	25
3015	1/2" x 3-1/2"	25	3059	1-1/2" x 4-1/2"	25
3016	1/2" x 4"	25	3060	1-1/2" x 5"	20
3017	1/2" x 4-1/2"	25	3061	1-1/2" x 5-1/2"	20
3018	1/2" x 5"	25	3062	1-1-1/2" x 6"	20
3019	1/2" x 5-1/2"	25			
3020	1/2" x 6"	25			

* = SPECIAL ORDER ITEM

**FOR ADDITIONAL INFORMATION, VISIT
THE ANVIL (ASC) WEBSITE AT: www.asc-es.com**

SEPTEMBER 2024

Line #0210

ANVIL (ASC)

GALVANIZED THREADED NIPPLES

SCHEDULE 40

102.3



ID ORDER#	SIZE	CTN QTY
3063	2" x close	25
3064	2" x 2-1/2"	25
3065	2" x 3"	25
3066	2" x 3-1/2"	25
3067	2" x 4"	25
3068	2" x 4-1/2"	25
3069	2" x 5"	25
3070	2" x 5-1/2"	25
3071	2" x 6"	25
3072 *	4" x 8"	5

ID ORDER#	SIZE	BOX QTY
<i>GALVANIZED ASSORTED NIPPLES — BOXED</i>		
3073	1/2"	66
3075	3/4"	66

* = SPECIAL ORDER ITEM

FOR ADDITIONAL INFORMATION, VISIT
THE ANVIL (ASC) WEBSITE AT: www.asc-es.com

ANVIL (ASC) BLACK MALLEABLE FITTINGS



	ID ORDER#	SIZE	CTN QTY
	3088	1/8"	50
	3089	1/4"	35
	3090	3/8"	45
	3091	1/2"	50
	3092	3/4"	35
	3093	1"	20
	3094	1-1/4"	20
	3095	1-1/2"	10
	3096	2"	8
	3097	2-1/2"	1
3098	3"	1	
3099	4"	1	

90° REDUCING ELBOWS

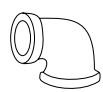

3100 *	1/4" x 1/8"	40
3101	3/8" x 1/4"	60
3102	1/2" x 3/8"	40
3103 *	3/4" x 3/8"	40
3104	3/4" x 1/2"	40
3105	1" x 1/2"	25
3106	1" x 3/4"	25
3107	1-1/4" x 3/4"	15
3108	1-1/4" x 1"	10
3109	1-1/2" x 3/4"	10
3110	1-1/2" x 1"	10
3111	1-1/2" x 1-1/4"	15
3113	2" x 1-1/4"	10
3114	2" x 1-1/2"	10
3115	2-1/2" x 1-1/2"	6
3116	2-1/2" x 2"	6
3117	3" x 2"	4
3118	3" x 2-1/2"	4

45° ELBOWS



3128	1/8"	50
3129	1/4"	30
3130	3/8"	50
3131	1/2"	50
3132	3/4"	40
3133	1"	20
3134	1-1/4"	20
3135	1-1/2"	10

45° ELBOWS (continued)



3136	2"	12
3137	2-1/2"	12
3138	3"	10
3139	4"	4

45° STREET ELBOWS



3140	1/8"	70
3141	1/4"	40
3142	3/8"	50
3143	1/2"	75
3144	3/4"	40
3145	1"	25
3146	1-1/4"	10
3147	1-1/2"	10
3148	2"	12

90° STREET ELBOWS



3119	1/8"	60
3120	1/4"	35
3121	3/8"	40
3122	1/2"	60
3123	3/4"	35
3124	1"	30
3125	1-1/4"	25
3126	1-1/2"	9
3127	2"	8

TEES



3149	1/8"	80
3150	1/4"	50
3151	3/8"	30
3152	1/2"	40
3153	3/4"	35
3154	1"	20
3155	1-1/4"	14
3156	1-1/2"	12
3157	2"	8
3158	2-1/2"	4
3159	3"	1
3160	4"	1



* = SPECIAL ORDER ITEM

FOR ADDITIONAL INFORMATION, VISIT
THE ANVIL (ASC) WEBSITE AT: www.asc-es.com

ANVIL (ASC) BLACK MALLEABLE & STEEL FITTINGS



ID ORDER#	SIZE	CTN QTY
REDUCING TEES		
 145818	1/2" x 1/2" x 3/4"	30
3161	3/4" x 1/2" x 1/2"	25
3162	3/4" x 1/2" x 3/4"	20
3164	3/4" x 3/4" x 1/2"	20
3165	3/4" x 3/4" x 1"	20
3166	1" x 1/2" x 1/2"	20
3167	1" x 1/2" x 3/4"	20
3168	1" x 1/2" x 1"	15
3169	1" x 1" x 3/8"	15
3170	1" x 1" x 1/2"	15
3171	1" x 1" x 3/4"	12
3172	1" x 3/4" x 1/2"	20
3174	1" x 3/4" x 3/4"	15
3175	1" x 3/4" x 1"	15
3176	1-1/4" x 1/2" x 1"	20
3177	1-1/4" x 1/2" x 1-1/4"	20
3178	1-1/4" x 3/4" x 3/4"	10
3179	1-1/4" x 3/4" x 1"	10
3180	1-1/4" x 3/4" x 1-1/4"	10
3181	1-1/4" x 1" x 3/4"	20
3182	1-1/4" x 1" x 1"	20
3183	1-1/4" x 1" x 1-1/4"	15
3184	1-1/4" x 1-1/4" x 1/2"	20
3185	1-1/4" x 1-1/4" x 3/4"	20
3186	1-1/4" x 1-1/4" x 1"	20
3188	1-1/2" x 1" x 1"	15
3189	1-1/2" x 1" x 1-1/4"	12
3190	1-1/2" x 1" x 1-1/2"	12
3191	1-1/2" x 1-1/4" x 3/4"	12
3192	1-1/2" x 1-1/4" x 1"	12
3193	1-1/2" x 1-1/4" x 1-1/4"	12
3194	1-1/2" x 1-1/4" x 1-1/2"	12
3195	1-1/2" x 1-1/2" x 1/2"	18
3196	1-1/2" x 1-1/2" x 3/4"	15
3198	1-1/2" x 1-1/2" x 1"	15
3199	1-1/2" x 1-1/2" x 1-1/4"	12
3200	2" x 1-1/4" x 1-1/4"	8
3201	2" x 1-1/4" x 1-1/2"	8
3202	2" x 1-1/4" x 2"	8
3203	2" x 1-1/2" x 1"	10
3204	2" x 1-1/2" x 1-1/4"	8
3205	2" x 1-1/2" x 1-1/2"	8
3206	2" x 1-1/2" x 2"	8
3207	2" x 2" x 1/2"	10
3208	2" x 2" x 3/4"	10
3209	2" x 2" x 1"	10
3210	2" x 2" x 1-1/4"	8
3211	2" x 2" x 1-1/2"	8
3212	2-1/2" x 2-1/2" x 1-1/2"	6

ID ORDER#	SIZE	CTN QTY
REDUCING TEES (continued)		
 3214	3" x 3" x 1-1/2"	3
3215	3" x 3" x 2"	3
3216	3" x 3" x 2-1/2"	3
3217	3" x 2" x 2"	3
3218	4" x 4" x 1-1/2"	4
3219	4" x 4" x 2"	1
3220 *	4" x 4" x 2-1/2"	1
3221	4" x 4" x 3"	1
CROSSES		
 3222	1/2"	30
3223	3/4"	20
3224	1"	15
3225 *	4"	1
MALLEABLE COUPLINGS		
178431	1/8"	70
178432	1/4"	40
178433	3/8"	40
178434	1/2"	40
178435	3/4"	50
178436	1"	25
178437	1-1/4"	16
178438	1-1/2"	18
178439	2"	12
178440	2-1/2"	8
178441	3"	1
178442	4"	3
STEEL CAPS		
 3574	1/8"	40
3575	1/4"	40
3576	3/8"	40





**FOR ADDITIONAL INFORMATION, VISIT
THE ANVIL (ASC) WEBSITE AT: www.asc-es.com**

* = SPECIAL ORDER ITEM

ANVIL (ASC)

BLACK MALLEABLE, CAST IRON & STEEL FITTINGS



ID ORDER#	SIZE	CTN QTY		ID ORDER#	SIZE	CTN QTY	
MALLEABLE CAPS				REDUCING COUPLINGS (continued)			
3577	1/2"	50		3243	3/4" x 3/8"	30	
3578	3/4"	40		3244	3/4" x 1/2"	60	
3579	1"	25		3245	1" x 3/8"	30	
3580	1-1/4"	20		3246	1" x 1/2"	30	
3581	1-1/2"	18		3247	1" x 3/4"	25	
3582	2"	12		3248	1-1/4" x 3/4"	25	
3583	2-1/2"	20		3249	1-1/4" x 1"	15	
3584	3"	1		3250	1-1/2" x 3/4"	15	
3585 *	3-1/2"	6		3251	1-1/2" x 1"	25	
3586	4"	6	3252	1-1/2" x 1-1/4"	12		
SOLID PLUGS				3253	2" x 3/4"	12	
3587 (steel)	1/8"	100	3254	2" x 1"	12		
3588	1/4"	150	3255	2" x 1-1/4"	9		
3589	3/8"	100	3256	2" x 1-1/2"	9		
CORED PLUGS				3257	2-1/2" x 1-1/4"	10	
3590	1/2"	50	3258	2-1/2" x 1-1/2"	7		
3591	3/4"	30	3259	2-1/2" x 2"	7		
C. I. CORED PLUGS				3261	3" x 1-1/4"	6	
	3592	1"	60	3566	3" x 1-1/2"	6	
	3593	1-1/4"	30	3567	3" x 2"	6	
	3594	1-1/2"	25	3568	3" x 2-1/2"	5	
	3595	2"	15	3569	4" x 2"	3	
	3596	2-1/2"	1	3571	4" x 3"	3	
	3597	3"	1	3572 *	4" x 3-1/2"	4	
	3598	3-1/2"	1	3573 *	5" x 4"	1	
	3599	4"	1	STEEL HEX BUSHINGS			
	217521	6"	1		3601	1/4" x 1/8"	100
				3602	3/8" x 1/8"	100	
				3603	3/8" x 1/4"	100	
				3604	1/2" x 1/8"	100	
				3605	1/2" x 1/4"	100	
				3606	1/2" x 3/8"	100	
				3607	3/4" x 1/8"	50	
				3608	3/4" x 1/4"	50	
				3609	3/4" x 3/8"	50	
REDUCING COUPLINGS				FOR ADDITIONAL INFORMATION, VISIT THE ANVIL (ASC) WEBSITE AT: www.asc-es.com			
	3238	1/4" x 1/8"	50				
	3239	3/8" x 1/8"	35				
	3240	3/8" x 1/4"	30				
	3241	1/2" x 1/8"	50				
	3242	1/2" x 1/4"	50				
	44885	1/2" x 3/8"	40				





* = SPECIAL ORDER ITEM

ANVIL (ASC)

BLACK MALLEABLE & CAST IRON FITTINGS



ID ORDER#	SIZE	CTN QTY
C. I. and MALLEABLE HEX BUSHINGS		
 3610 (mal.)	3/4" x 1/2"	50
3611 (mal.)	1" x 1/8"	50
3612 (mal.)	1" x 1/4"	50
3613 (mal.)	1" x 3/8"	50
3614 (mal.)	1" x 1/2"	50
3615 (mal.)	1" x 3/4"	50
3617 (mal.)	1-1/4" x 1/4"	30
3618 (mal.)	1-1/4" x 3/8"	30
3619 (mal.)	1-1/4" x 1/2"	30
3620 (mal.)	1-1/4" x 3/4"	30
3621 (mal.)	1-1/4" x 1"	30
3623	1-1/2" x 1/4"	25
3624 *	1-1/2" x 3/8"	25
3625	1-1/2" x 1/2"	25
3626	1-1/2" x 3/4"	25
3627	1-1/2" x 1"	25
3628 (mal.)	1-1/2" x 1-1/4"	25
3630	2" x 1/2"	15
3631	2" x 3/4"	15
3632	2" x 1"	15
3633	2" x 1-1/4"	15
3634 (mal.)	2" x 1-1/2"	20
3635	2-1/2" x 3/4"	1
3636	2-1/2" x 1"	1
3637	2-1/2" x 1-1/4"	1
3638	2-1/2" x 1-1/2"	1
3639 (mal.)	2-1/2" x 2"	15
3640 *	3" x 1/2"	1
3641	3" x 3/4"	1
3642	3" x 1"	1
3643	3" x 1-1/4"	1
3644	3" x 1-1/2"	1
3645	3" x 2"	1
3646	3" x 2-1/2"	1
3647 *	3-1/2" x 1"	1
3648 *	3-1/2" x 1-1/4"	1
3649 *	3-1/2" x 1-1/2"	1
3650	3-1/2" x 2"	1
3651 *	3-1/2" x 2-1/2"	1
3652	3-1/2" x 3"	1
3653	4" x 1-1/4"	1
3654	4" x 1-1/2"	1
3655	4" x 2"	20
3656	4" x 2-1/2"	1
3657	4" x 3"	25
3658 *	4" x 3-1/2"	1







ID ORDER#	SIZE	CTN QTY
C. I. and MALLEABLE HEX BUSHINGS (continued)		
 70391	5" x 3"	1
3659	5" x 4"	1
3660	6" x 3"	1
3661	6" x 4"	1
3662	6" x 5"	1
150 LB. MALLEABLE UNIONS		
 3663	1/8"	60
3664	1/4"	20
3665	3/8"	40
3666	1/2"	50
3667	3/4"	35
3668	1"	20
3669	1-1/4"	15
3670	1-1/2"	10
3671	2"	6
3672	2-1/2"	4
3673	3"	4
C. I. FLANGED UNIONS		
 3676 *	2-1/2"	1
3677 *	3"	1
3678 *	3-1/2"	1
3679	4"	1
C. I. COMPANION FLANGES I.P.S.		
 3681	2" x 6"	1
3682	2-1/2" x 7"	1
3683	3" x 7-1/2"	1
3684 *	3-1/2" x 8-1/2"	1
3685	4" x 9"	1
3686 *	6" x 11"	1
GASKET & BOLT SETS FOR COMPANION FLANGES (Matco-Norca)		
GSAFFG2	160261 2"	4
GSAFFG2.5	160263 2-1/2"	4
GSAFFG3	160264 3"	4
GSAFFG4	160265 4"	8

* = SPECIAL ORDER ITEM

**FOR ADDITIONAL INFORMATION, VISIT
THE ANVIL (ASC) WEBSITE AT: www.asc-es.com**

ANVIL (ASC) GALVANIZED MALLEABLE FITTINGS



90° ELBOWS				45° STREET ELBOWS			
ID ORDER#	SIZE	CTN QTY		ID ORDER#	SIZE	CTN QTY	
	3687	1/8"	50		3727	1/8"	70
	3688	1/4"	35		3728	1/4"	40
	3689	3/8"	45		3729	3/8"	100
	3690	1/2"	50		3730	1/2"	75
	3691	3/4"	35v		3731	3/4"	40
	3692	1"	2		3732	1"	25
	3693	1-1/4"	20		3734	1-1/2"	10
	3694	1-1/2"	10		3735	2"	12
	3695	2"	8				
	3696	3"	1				
90° REDUCING ELBOWS				90° STREET ELBOWS			
	3698	1/2" x 1/4"	40		3709	1/8"	60
	3697	1/2" x 3/8"	40		3710	1/4"	35
	3699	3/4" x 1/2"	40		3711	3/8"	40
	3700	1" x 1/2"	25		3712	1/2"	60
	3701	1" x 3/4"	25		3713	3/4"	35
	3702	1-1/4" x 1/2"	20		3714	1"	30
	3703	1-1/4" x 3/4"	15		3715	1-1/4"	25
	3704	1-1/4" x 1"	10		3716	1-1/2"	9
	3705	1-1/2" x 1-1/4"	15		3717	2"	8
	3706	1-1/2" x 1"	10				
	3707	2" x 1-1/4"	12				
	3708	2" x 1-1/2"	10				
45° ELBOWS				TEES			
	3718	1/8"	50		3736	1/8"	80
	3719	1/4"	30		3737	1/4"	50
	3720	3/8"	50		3738	3/8"	30
	3721	1/2"	50		3739	1/2"	40
	3722	3/4"	40		3740	3/4"	35
	3723	1"	20		3741	1"	20
	3724	1-1/4"	20		3742	1-1/4"	14
	3725	1-1/2"	10		3743	1-1/2"	12
	3726	2"	12		3744	2"	8

**FOR ADDITIONAL INFORMATION, VISIT
THE ANVIL (ASC) WEBSITE AT: www.asc-es.com**

ANVIL (ASC)

GALVANIZED MALLEABLE, CAST IRON & STEEL FITTINGS



ID ORDER#	SIZE	CTN QTY
REDUCING TEES		
 30386 *	1/4" x 1/4" x 1/8"	25
3745	1/2" x 1/2" x 3/4"	30
3746	3/4" x 1/2" x 1/2"	25
3747	3/4" x 1/2" x 3/4"	20
3748	3/4" x 3/4" x 1/2"	20
3749	3/4" x 3/4" x 1"	20
3750	1" x 3/4" x 1/2"	20
3751	1" x 3/4" x 3/4"	15
3752	1" x 3/4" x 1"	15
3753	1" x 1" x 1/2"	15
3754	1" x 1" x 3/4"	12
3755	1-1/4" x 1-1/4" x 3/4"	20
3756	1-1/4" x 1-1/4" x 1"	20
3757 *	1-1/4" x 1" x 3/4"	20
3758	1-1/4" x 1" x 1"	20
3760	1-1/2" x 1" x 1"	15
3762	1-1/2" x 1-1/4" x 1"	12
3765	1-1/2" x 1-1/2" x 1/2"	18
3766	1-1/2" x 1-1/2" x 3/4"	15
3767	1-1/2" x 1-1/2" x 1"	15
3768	1-1/2" x 1-1/2" x 1-1/4"	12
3771	2" x 1-1/2" x 1"	10
3769 *	2" x 1-1/2" x 1-1/4"	8
3772	2" x 2" x 3/4"	10
3774	2" x 2" x 1"	10
3775	2" x 2" x 1-1/4"	8
3776	2" x 2" x 1-1/2"	8

HEX BUSHINGS

STEEL



3777	1/4" x 1/8"	100
3778	3/8" x 1/8"	100
3779	3/8" x 1/4"	100
3780	1/2" x 1/8"	100
3781	1/2" x 1/4"	100
3782	1/2" x 3/8"	100
3783	3/4" x 1/8"	50
3784	3/4" x 1/4"	50
3785	3/4" x 3/8"	50
3786	3/4" x 1/2"	50

HEX BUSHINGS

MALLEABLE & CAST IRON

3787	1" x 3/8"	50
3788	1" x 1/2"	50
3789	1" x 3/4"	50
3790 *	1-1/4" x 1/4"	30
3791	1-1/4" x 1/2"	30
3792	1-1/4" x 3/4"	30
3793	1-1/4" x 1"	30
3794 (C.I.)	1-1/2" x 1/2"	25
3795 (C.I.)	1-1/2" x 3/4"	25
3796 (C.I.)	1-1/2" x 1"	25
3797	1-1/2" x 1-1/4"	25
3798 (C.I.)	2" x 3/4"	15
3799 (C.I.)	2" x 1"	15
3800 (C.I.)	2" x 1-1/4"	15
3801	2" x 1-1/2"	20

CAST IRON CORED PLUGS



3803	1"	60
3804	1-1/4"	30
3805	1-1/2"	25
3807	2"	15

STEEL SOLID PLUGS



3808	1/8"	100
3809	1/4"	100
3811	3/8"	100
3813	1/2"	100
3802	3/4"	100





**FOR ADDITIONAL INFORMATION, VISIT
THE ANVIL (ASC) WEBSITE AT: www.asc-es.com**

* = SPECIAL ORDER ITEM

ANVIL (ASC)

GALVANIZED MALLEABLE, CAST IRON & STEEL FITTINGS



	ID ORDER#	SIZE	CTN QTY		ID ORDER#	SIZE	CTN QTY
MALLEABLE COUPLINGS				FLOOR FLANGES			
	178443	1/8"	70		3852	1/2"	25
	178444	1/4"	40		3853	3/4"	15
	178445	3/8"	40				
	178446	1/2"	40		3854	1"	15
	178447	3/4"	50		3855	1-1/4"	10
					3856	1-1/2"	8
	178448	1"	25				
	178449	1-1/4"	16		3857	2"	8
	178450	1-1/2"	18				
	178451	2"	12				
REDUCING COUPLINGS				CAPS			
	3824	1/4" x 1/8"	50		STEEL		
	3825	3/8" x 1/4"	30		3858	1/8"	40
	3826	1/2" x 1/8"	50		3859	1/4"	40
	3827	1/2" x 1/4"	50		3860	3/8"	40
	3828	1/2" x 3/8"	40		3861	1/2"	40
	3829	3/4" x 1/2"	60		3862	3/4"	40
	3830	1" x 1/2"	30		MALLEABLE		
	3831	1" x 3/4"	25		3863	1"	25
	3832	1-1/4" x 3/4"	25		3864	1-1/4"	20
	3834	1-1/4" x 1"	15		3865	1-1/2"	18
	233995	1-1/2" x 3/4"	15		3866	2"	12
	3835	1-1/2" x 1"	25				
	3836	1-1/2" x 1-1/4"	12				
	3837	2" x 3/4"	12				
	3838	2" x 1"	12				
	3839	2" x 1-1/4"	9				
	3840	2" x 1-1/2"	9				
150 LB. UNIONS				FOR ADDITIONAL INFORMATION, VISIT THE ANVIL (ASC) WEBSITE AT: www.asc-es.com			
	3841	1/8"	60				
	3842	1/4"	20				
	3844	3/8"	40				
	3845	1/2"	50				
	3846	3/4"	35				
	3847	1"	20				
	3848	1-1/4"	15				
	3849	1-1/2"	10				
	3850	2"	6				

WATER TUBE LINE #0340

Note: Pricing per 100'

* = SPECIAL ORDER ITEM

	1/4"	3/8"	1/2"	3/4"	1"	1-1/4"	1-1/2"	2"	2-1/2"	3"	4"
"K" soft coil (60')	--	--	--	--	--	--	--	--	--	--	--
ID ORDER#			1987	1989	1991	1993 *					
"K" soft coil (100')	--	--	--	--	--	--	--	--	--	--	--
ID ORDER#			1988	1990	1992						
"L" soft coil (60')	--	--	--	--	--	--	--	--	--	--	--
ID ORDER#	2008	2010	2020	2001	2006 *	2025 *	26085 *				
"L" soft coil (100')	--	--	--	--	--	--	--	--	--	--	--
ID ORDER#	2009 *	2011	1996	2003	2023 *						
"L" hard (20' length)	--	--	--	--	--	--	--	--	--	--	--
ID ORDER#			2028	2030	2032	2035	2037	2038	21772	46517	
"M" hard (10' length)	--	--	--	--	--	--	--	--	--	--	--
ID ORDER#			15558	15559	43722	53652					
"M" hard (20' length)	--	--	--	--	--	--	--	--	--	--	--
ID ORDER#			2044	2046	2048	2051	2053	2056	46521	2059	

REFRIGERATION TUBE, SEALED LINE #0340

Note: Pricing per 100'

	1/8"	3/16"	1/4"	5/16"	3/8"	1/2"	5/8"	3/4"	7/8"	1-1/8"
Service tube, 100' coil	--	--	--	--	--	--	--	--	--	--
ID ORDER#				227850		227851	79641	579105		
Service tube, 50' coil	--	--	--	--	--	--	--	--	--	--
ID ORDER#	2063 *	2066 *	2071	12535	2073	2075	2067	2068	2069	12039
ACR Nitrogenized, 20' lgth	--	--	--	--	--	--	--	--	--	--
ID ORDER#					12278	33290	11993	11994	11995	11996





ALUMINUM TUBE LINE #0350

ID ORDER#	DESCRIPTION
1461	ALUMINUM TUBE, 1/4" O.D., 50' coil

FOR LINESETS, SEE THE 500 SECTION

REFRIGERATION FITTINGS

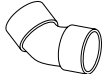
SOLDER PRESSURE

	ID ORDER#	O.D. SIZE	CTN QTY
SOLDER PRESSURE FITTINGS - Sized for O.D. tubing.			* = SPECIAL ORDER ITEM
600 COUPLINGS WITH STOP (C x C)			
	27018	1/4" O.D.	100
	27019	5/16" O.D.	100
	1882	3/8" O.D.	50
	1884	1/2" O.D.	50
	1886	5/8" O.D.	50
	39910	3/4" O.D.	50
	1887	7/8" O.D.	25
	1889	1-1/8" O.D.	10
	1891	1-3/8" O.D.	25
	1899	1-5/8" O.D.	10
600 REDUCING COUPLINGS WITH STOP (C x C)			
	51646	3/8" x 5/16" O.D.	50
	37393	1/2" x 3/8" O.D.	50
	1903	5/8" x 3/8" O.D.	100
	1904	5/8" x 1/2" O.D.	100
	75219	3/4" x 5/8" O.D.	100
	1906	7/8" x 5/8" O.D.	25
	21562	7/8" x 3/4" O.D.	100
	1909	1-1/8" x 5/8" O.D.	25
	1910	1-1/8" x 7/8" O.D.	25
	1912	1-3/8" x 5/8" O.D.	10
	1914	1-3/8" x 7/8" O.D.	10
	1916	1-3/8" x 1-1/8" O.D.	10
	1921	1-5/8" x 7/8" O.D.	10
	1923	1-5/8" x 1-1/8" O.D.	10
	1925	1-5/8" x 1-3/8" O.D.	10
606 45° ELBOWS (C x C)			
	19500	3/8" O.D.	50
	2060	1/2" O.D.	50
	2061	5/8" O.D.	50
	119763	3/4" O.D.	50
	2062	7/8" O.D.	25
	2064	1-1/8" O.D.	10
	2065	1-3/8" O.D.	10
	2070	1-5/8" O.D.	10
607-LT 90° SWEEP ELBOWS (C x C)			
	19501	3/8" O.D.	50
	75218	5/16" O.D.	50
	21104	1/2" O.D.	50
	21115	5/8" O.D.	50
	39911	3/4" O.D.	50
	2123	7/8" O.D.	25
	2129	1-1/8" O.D.	10
	2132 *	1-3/8" x 1-1/8" O.D.	10
	2133 *	1-5/8" x 1-1/8" O.D.	5
	2134 *	1-5/8" x 1-3/8" O.D.	5

FOR SEALED REFRIGERATION TUBE, SEE PAGE 103

COPPER FITTINGS

FLARED TUBE & SOLDER PRESSURE

ID ORDER#	NOM. SIZE	CTN QTY
-----------	-----------	---------

SOLDER PRESSURE FITTINGS

600 COUPLINGS WITH STOP (C x C)



1882	1/4"	50
1884	3/8"	50
1886	1/2"	50
39910	5/8"	50
1887	3/4"	25
1889	1"	10
1891	1-1/4"	25
1899	1-1/2"	10
1900	2"	1
1901	2-1/2"	1
1902	3"	1

600 REDUCING COUPLINGS WITH STOP (C x C)



37393	3/8" x 1/4"	50
1903	1/2" x 1/4"	100
1904	1/2" x 3/8"	100
75219	5/8" x 1/2"	100
1906	3/4" x 1/2"	25
1909	1" x 1/2"	25
1910	1" x 3/4"	25
1912	1-1/4" x 1/2"	10
1914	1-1/4" x 3/4"	10
1916	1-1/4" x 1"	10
1921	1-1/2" x 3/4"	10
1923	1-1/2" x 1"	10
1925	1-1/2" x 1-1/4"	10
1928	2" x 1"	1
1929	2" x 1-1/4"	1
1930	2" x 1-1/2"	1
1931	2-1/2" x 1-1/4"	1
1933	2-1/2" x 1-1/2"	1
1934	2-1/2" x 2"	1
1935	3" x 2"	1
1937	3" x 2-1/2"	1

600-2 REDUCING STREET COUPLINGS (FTG x C)



1939	3/4" x 1/2"	25
1941	1" x 1/2"	25
1944	1" x 3/4"	25
1945	1-1/4" x 1/2"	10
1946	1-1/4" x 3/4"	10
1948	1-1/4" x 1"	10
151719	1-1/2" x 1/2"	10
151718	1-1/2" x 3/4"	10
1949	1-1/2" x 1"	10
1950	1-1/2" x 1-1/4"	10
127281	2" x 1/2"	1
151721	2" x 3/4"	1
1952	2" x 1"	1
1953	2" x 1-1/4"	1
1955	2" x 1-1/2"	1

600-2 REDUCING STREET COUPLINGS (FTG x C) (continued)



151725	2-1/2" x 1-1/4"	1
151724	2-1/2" x 1-1/2"	1
151723	2-1/2" x 2"	1
151722	3" x 1-1/2"	1
127278	3" x 2"	1
127277	3" x 2-1/2"	1

601 COUPLINGS, LESS STOP (C x C)

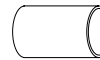

1956	1/2"	100
1961	3/4"	50
1964	1"	25
1965	1-1/4"	25
1970	1-1/2"	10
1973	2"	1

603 ADAPTERS (C x F)



1974	3/8"	50
1975	1/2"	50
1976	3/4"	25
1977	1"	10
1978	1-1/4"	10
1980	1-1/2"	10
1981	2"	1
1982	2-1/2"	1
1983	3"	1

603R REDUCING ADAPTERS (C x F)

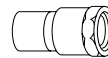

1995	1/2" x 1/4"	50
1997	1/2" x 3/8"	50
1998	1/2" x 3/4"	25
1999	3/4" x 1/2"	25
2000	3/4" x 1"	25
2002	1" x 3/4"	25
2005	1-1/4" x 1"	10
2007	1-1/4" x 1-1/2"	10

603-2 ADAPTERS (FTG x F)

11664	1/2"	50
2024	3/4"	25
11054	1"	25

C = Copper **FL = Flare**
F = Female **FTG = Street fitting**
M = Male

	ID ORDER#	NOM. SIZE	CTN QTY
604 ADAPTERS (C x M)			
	2026	3/8"	50
	2027	1/2"	50
	2029	1/2" x 3/8"	50
	2031	1/2" x 1/4"	25
	2033	1/2" x 3/4"	25
	2034	3/4"	25
	2036	3/4" x 1/2"	25
	2039	3/4" x 1"	10
	2040	1"	10
	2041	1" x 3/4"	10
	2042	1" x 1-1/4"	10
	2043	1-1/4"	10
	2045	1-1/4" x 3/4"	10
	2047	1-1/4" x 1"	10
	2049	1-1/4" x 1-1/2"	10
	2050	1-1/2"	10
	2052	1-1/2" x 1-1/4"	10
	2054	2"	1
	2055	2-1/2"	1
	2057	3"	1

604-2 ADAPTERS (FTG x M)			
	5679	1/2"	50

	ID ORDER#	NOM. SIZE	CTN QTY
606 45° ELBOWS (C x C)			
	19500	1/4"	50
	2060	3/8"	50
	2061	1/2"	50
	119763	5/8"	50
	2062	3/4"	25
	2064	1"	10
	2065	1-1/4"	10
	2070	1-1/2"	10
	2072	2"	10
	2074	2-1/2"	5
	2076	3"	2

	ID ORDER#	NOM. SIZE	CTN QTY
606-2 45° STREET ELBOWS (FTG x C)			
	719974	1/4"	100
	2078	1/2"	50
	173099	5/8"	50
	2079	3/4"	25
	2080	1"	30
	2081	1-1/4"	10
	2082	1-1/2"	10
	2083	2"	5
	2084	2-1/2"	2
	2086	3"	2

	ID ORDER#	NOM. SIZE	CTN QTY
607 90° ELBOWS (C x C)			
	2087	3/8"	50
	2088	1/2"	50
	2090	3/4"	25
	2092	3/4" x 1/2"	50
	2094	1"	10
	2099	1" x 3/4"	25
	2102	1-1/4"	10
	2104	1-1/4" x 1"	20
	2105	1-1/2"	10
	2106	1-1/2" x 1-1/4"	5
	2107	2"	10
2109	2-1/2"	5	
2111	3"	5	

	ID ORDER#	NOM. SIZE	CTN QTY
607-2 90° STREET ELBOWS (FTG x C)			
	2115	1/2"	50
	2116	3/4"	25
	2117	1"	10
	2118	1-1/4"	25
	2119	1-1/2"	10
	2120	2"	10
	2121	2-1/2"	5
	2122	3"	2

	ID ORDER#	NOM. SIZE	CTN QTY
607-LT 90° LONG SWEEP ELBOWS (C x C)			
	19501	1/4"	50
	75218	5/16"	50
	21104	3/8"	50
	21115	1/2"	50
	39911	5/8"	50
	2123	3/4"	25
	2129	1"	10
	2132 *	1-1/4" x 1"	10
	2133 *	1-1/2" x 1"	5
	2134 *	1-1/2" x 1-1/4"	5
	2135 *	2" x 1-1/4"	1

	ID ORDER#	NOM. SIZE	CTN QTY
607-2LT 90° STREET LONG SWEEP ELBOWS (FTG x C)			
	75210	1/4"	50
	75212	3/8"	50
	75213	1/2"	50
	75214	5/8"	25
	75215	3/4"	25
	75216	1"	10

* = SPECIAL ORDER ITEM

C = Copper
F = Female
FL = Flare
FTG = Street fitting
M = Male

COPPER FITTINGS

SOLDER PRESSURE

ID ORDER#	NOM. SIZE	CTN QTY
611 TEES (C x C x C)		
	2136 3/8"	50
	2137 1/2"	50
	2138 3/4"	25
	2139 1/2" x 1/2" x 3/4"	25
	2140 3/4" x 1/2" x 1/2"	25
	2141 3/4" x 1/2" x 3/4"	25
	2142 3/4" x 3/4" x 1/2"	25
	2143 3/4" x 3/4" x 1"	10
	2144 1"	10
	2146 1" x 1/2" x 1/2"	10
	2147 1" x 1/2" x 3/4"	10
	2148 1" x 3/4" x 1/2"	10
	2149 1" x 3/4" x 3/4"	10
	2150 1" x 3/4" x 1"	10
	2151 1" x 1" x 1/2"	10
	2152 1" x 1" x 3/4"	10
	2153 1" x 1" x 1-1/4"	5
	2154 1-1/4"	5
	2155 1-1/4" x 1/2" x 1-1/4"	5
	2156 1-1/4" x 3/4" x 1/2"	5
	2157 1-1/4" x 3/4" x 3/4"	5
	2158 1-1/4" x 3/4" x 1"	5
	2159 1-1/4" x 3/4" x 1-1/4"	5
	2160 1-1/4" x 1" x 1/2"	5
	2161 1-1/4" x 1" x 3/4"	5
	2162 1-1/4" x 1" x 1"	5
	2163 1-1/4" x 1" x 1-1/4"	5
	2223 1-1/4" x 1-1/4" x 1/2"	5
	2211 1-1/4" x 1-1/4" x 3/4"	5
	2231 1-1/4" x 1-1/4" x 1"	5
	2233 1-1/4" x 1-1/4" x 1-1/2"	5
	2235 1-1/2"	5
	2237 1-1/2" x 1/2" x 1-1/2"	5
	2240 1-1/2" x 3/4" x 1-1/2"	5
	2239 1-1/2" x 3/4" x 1-1/2"	5
	2242 1-1/2" x 1" x 1"	5
	2243 1-1/2" x 1-1/4" x 3/4"	5
	2244 1-1/2" x 1-1/4" x 1"	5
	2245 1-1/2" x 1-1/4" x 1-1/4"	5
	2246 1-1/2" x 1-1/4" x 1-1/2"	5
	2247 1-1/2" x 1-1/2" x 1/2"	5
	2248 1-1/2" x 1-1/2" x 3/4"	5
	2249 1-1/2" x 1-1/2" x 1"	5
	2250 1-1/2" x 1-1/2" x 1-1/4"	5
	2251 2"	5
	2252 2" x 1/2" x 2"	5
	2253 2" x 1" x 2"	5
	2254 2" x 1-1/4" x 1"	2
	2255 2" x 1-1/4" x 1-1/4"	2
	2256 2" x 1-1/4" x 1-1/2"	2
	2257 2" x 1-1/4" x 2"	2

ID ORDER#	NOM. SIZE	CTN QTY
611 TEES (C x C x C)		
	2258 2" x 1-1/2" x 1"	2
	2259 2" x 1-1/2" x 1-1/4"	2
	2260 2" x 1-1/2" x 1-1/2"	2
	2261 2" x 1-1/2" x 2"	2
	2262 2" x 2" x 1/2"	5
	2263 2" x 2" x 3/4"	5
	2264 2" x 2" x 1"	5
	2265 2" x 2" x 1-1/4"	5
	2266 2" x 2" x 1-1/2"	5
	2267 2-1/2"	1
	2268 2-1/2" x 2-1/2" x 2"	1
	2269 3"	1
	2270 3" x 3" x 2"	1
	2271 3" x 3" x 2-1/2"	1

617 TUBE CAPS (C)

	2272 1/2"	50
	2275 3/4"	25
	2276 1"	10
	2277 1-1/4"	25
	2278 1-1/2"	25
	2279 2"	1
	2280 2-1/2"	1
	2281 3"	1

618 FLUSH BUSHINGS (FTG x C)

	2282 1/2" x 3/8"	100
	2283 3/4" x 1/2"	50
	2284 1" x 3/4"	50
	2285 1-1/4" x 1"	10
	2289 1-1/2" x 1-1/4"	10

618-3-NL FLUSH BUSHINGS (STR x F)

	698862 1/2" x 1/4"	50
---	--------------------	----









619 AIR CHAMBERS (C) (lead free)



	2292 1/2" x 12"	1
--	-----------------	---

C = Copper
F = Female
FL = Flare

FTG = Street fitting
M = Male

COPPER FITTINGS SOLDER PRESSURE

	ID ORDER#	NOM. SIZE	CTN QTY
701-D-NL DRAIN COUPLINGS (C x C)			
	682713	1/2"	10
	682716	3/4"	10
705-NL BASEBOARD (VENT) TEES (C x F x C)			
	685591	1/2" x 1/8" x 1/2"	50
	684690	3/4" x 1/8" x 3/4"	25
	685592	1" x 1/8" x 1"	10
705-D-NL VENT (DRAIN) ELBOWS (C x C)			
	682718	1/2"	50
	682719	3/4"	25
T-149 VENT CAPS WITH WASHER FOR 701-D AND 705-D			
	2364	1/8"	10
707-3 & 707-3-NL 90° ELBOWS (C x F)			
	2313	1/2"	50
	682744 (NL)	3/4"	25
	2319	1"	10
	2320	1-1/4"	5
	682746 (NL)	1-1/4"	5
707-3-5 & 707-3-5-NL 90° DROP EAR ELBOWS (C x F)			
	682758 (NL)	1/2"	25
	2322	1/2" x 3/8"	50
	682760 (NL)	3/4" x 1/2"	25
707-4 & 707-4-NL 90° ELBOWS (C x M)			
	682761 (NL)	1/2"	50
	2326	3/4"	25
707-5-NL DROP EAR 90° ELBOWS (C x C)			
	682761 (NL)	1/2"	50
711-5 DROP EAR TEES (C x C x C)			
	2334	1/2"	25
712 & 712-NL TEES (C x C x F)			
	2336	1/2"	25
	682768 (NL)	3/4"	10

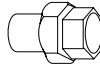
	ID ORDER#	NOM. SIZE	CTN QTY
712-5-NL DROP TEES (C x C x F)			
	685894	1/2"	25
718-3-NL FLUSH BUSHINGS (FTG x F)			
	2350	1" x 1/2"	50
733 & 733-NL UNIONS (C x C)			
	2352	1/2"	25
	2353	3/4"	25
	2354	1"	10
	682774 (NL)	1-1/4"	1
	682275 (NL)	1-1/2"	1
	682776 (NL)	2"	1

COMPANION FLANGES (C x FLANGE)
(no-lead, 2-piece WROT, 150#)

773436	W02980NL	2"	1
692958	W02746NL	2-1/2"	1
692959	W02802NL	3"	1
773438	W01940NL	4"	1

NOTE: For companion flange gasket bolt sets, see page 102.7

C = Copper
F = Female
FL = Flare
FTG = Street fitting
M = Male

MAXIPRO REFRIGERANT PRESS FITTINGS



ID ORDER#	MODEL#	SIZE	DESCRIPTION	CTN QTY
PRESS ELBOWS				
774526	MPA50410090001	1-1/8"	45° PRESS ELBOW	2/bag
774523	MPA50020020001	1/4"	90° PRESS ELBOW	5/bag
774460	MPA50020030001	3/8"	<i>Same as above</i>	5/bag
774459	MPA50020040001	1/2"	<i>Same as above</i>	3/bag
774465	MPA50020050001	5/8"	<i>Same as above</i>	3/bag
774456	MPA50020060001	3/4"	<i>Same as above</i>	3/bag
774454	MPA50020070001	7/8"	<i>Same as above</i>	3/bag
774525	MPA50020090001	1-1/8"	<i>Same as above</i>	2/bag
PRESS COUPLERS				
774469	MPA52400060501	3/4" x 5/8"	REDUCING COUPLER	2/bag
774468	MPA52400070601	7/8" x 3/4"	<i>Same as above</i>	2/bag
774467	MPA52400090701	1-1/8" x 7/8"	<i>Same as above</i>	1/bag
774463	MPA52700020001	1/4"	STRAIGHT COUPLER	5/bag
774439	MPA52700030001	3/8"	<i>Same as above</i>	5/bag
774461	MPA52700040001	1/2"	<i>Same as above</i>	5/bag
774466	MPA52700050001	5/8"	<i>Same as above</i>	5/bag
774453	MPA52700060001	3/4"	<i>Same as above</i>	2/bag
774455	MPA52700070001	7/8"	<i>Same as above</i>	2/bag
774529	MPA52700090001	1-1/8"	<i>Same as above</i>	2/bag
PRESS SIMPLE FLARE ADAPTERS				
774458	MPA5285G0020201	1/4"	SIMPLE FLARE ADAPTER , with brass nut	4/bag
774457	MPA5285G0030301	3/8"	<i>Same as above</i>	4/bag
774462	MPA5285G0040401	1/2"	<i>Same as above</i>	4/bag
774464	MPA5285G0050501	5/8"	<i>Same as above</i>	2/bag

**FOR ADDITIONAL INFORMATION, VISIT THE
MAXIPRO WEBSITE AT www.reece.conexbanninger.com**

SEPTEMBER 2024

Line #5611

MAXIPRO REFRIGERANT PRESS FITTING TOOLS

104.1



ID ORDER#	MODEL#	DESCRIPTION
774482	1000001929	ROMAX 4000 32KN PRESS MACHINE WITHOUT JAWS
774479	1000002206	ROMAX STANDARD 7-JAW SET, 1/4", 3/8", 1/2", 5/8", 3/4", 7/8" and 1-1/8"
774483	1000002128	"TT" TWIN TURBO 24KN COMPACT PRESS TOOL WITHOUT JAWS
774480	1000002602	TWIN TURBO 6-JAW SET, 1/4", 3/8", 1/2", 5/8", 3/4" and 7/8"
774481	1000002491	TWIN TURBO JAW SET, 1-1/8"

FOR ADDITIONAL INFORMATION, VISIT THE
MAXIPRO WEBSITE AT www.reece.conexbanninger.com

LEGEND

COPPER PRESS VALVES & FITTINGS



ID ORDER#	MODEL#	SIZE	DESCRIPTION	CTN QTY
PRESS ADAPTERS				* = SPECIAL ORDER ITEM
739035	450-703P	1/2"	ADAPTER—PRESS x FNPT	10
739036	450-704P	3/4"	<i>Same as above</i>	10
739037	450-705P	1"	<i>Same as above</i>	10
739038	450-706P	1-1/4"	<i>Same as above</i>	1
739039	450-707P	1-1/2"	<i>Same as above</i>	1
739040	450-708P	2"	<i>Same as above</i>	1
739041	450-753P	1/2"	ADAPTERS—PRESS x MNPT	10
739042	450-754P	3/4"	<i>Same as above</i>	10
739043	450-755P	1"	<i>Same as above</i>	10
739044	450-756P	1-1/4"	<i>Same as above</i>	1
739045 *	450-757P	1-1/2"	<i>Same as above</i>	1
739046 *	450-758P	2"	<i>Same as above</i>	1
752303	450-853P	1/2"	ADAPTERS—PRESS x F1807 PEX	30
748782	450-854P	3/4"	<i>Same as above</i>	25
748783	450-855P	1"	<i>Same as above</i>	30
PRESS REDUCING ADAPTERS				
739270	450-784P	3/4" x 1/2"	REDUCING ADAPTER—PRESS x MNPT	10
739272	450-787P	1" x 3/4"	<i>Same as above</i>	10
739274	450-791P	1-1/4" x 1"	<i>Same as above</i>	1
PRESS BALL VALVES				
739315	101-003NL	1/2"	BALL VALVE—P-200NL SERIES, lead-free brass	5
739316	101-004NL	3/4"	<i>Same as above</i>	5
739317	101-005NL	1"	<i>Same as above</i>	3
739318	101-006NL	1-1/4"	<i>Same as above</i>	2
739375	101-007NL	1-1/2"	<i>Same as above</i>	2
739384	101-008NL	2"	<i>Same as above</i>	2
PRESS CAPS				
739015	450-483P	1/2"	CAP—PRESS x PRESS x PRESS	10
739016	450-484P	3/4"	<i>Same as above</i>	10
739017	450-485P	1"	<i>Same as above</i>	5
749018	450-486P	1-1/4"	<i>Same as above</i>	1
739019	450-487P	1-1/2"	<i>Same as above</i>	1
739020	450-488P	2"	<i>Same as above</i>	1

FOR ADDITIONAL INFORMATION, VISIT THE LEGEND WEBSITE AT www.legendvalve.com

LEGEND

COPPER PRESS VALVES & FITTINGS



ID ORDER#	MODEL#	SIZE	DESCRIPTION	CTN QTY
PRESS COUPLINGS				* = SPECIAL ORDER ITEM
739208	450-423P	1" x 1/2"	REDUCING COUPLING—FITTING x PRESS	10
739211	450-427P	1-1/4" x 3/4"	<i>Same as above</i>	5
739212	450-428P	1-1/4" x 1"	<i>Same as above</i>	5
739214	450-430P	1-1/2" x 3/4"	<i>Same as above</i>	1
739215	450-431P	1-1/2" x 1"	<i>Same as above</i>	1
739216	450-432P	1-1/2" x 1-1/4"	<i>Same as above</i>	1
739218	450-434P	2" x 3/4"	<i>Same as above</i>	1
739219	450-435P	2" x 1"	<i>Same as above</i>	1
739220	450-436P	2" x 1-1/4"	<i>Same as above</i>	1
739221	450-437P	2" x 1-1/2"	<i>Same as above</i>	1
739238	450-540P	1-1/2" x 3/4"	REDUCING COUPLING—PRESS x PRESS	1
739239	450-541P	1-1/2" x 1"	<i>Same as above</i>	1
739240	450-542P	1-1/2" x 1-1/4"	<i>Same as above</i>	1
739242	450-546P	2" x 1"	<i>Same as above</i>	1
739243	450-547P	2" x 1-1/4"	<i>Same as above</i>	1
739244	450-547P	2" x 1-1/2"	<i>Same as above</i>	1
PRESS COUPLINGS WITH STOPS				
739021	450-503P	1/2"	COUPLING WITH STOP—PRESS x PRESS	10
739022	450-504P	3/4"	<i>Same as above</i>	10
739023	450-505P	1"	<i>Same as above</i>	5
739024	450-506P	1-1/4"	<i>Same as above</i>	1
739025	450-507P	1-1/2"	<i>Same as above</i>	1
739026	450-508P	2"	<i>Same as above</i>	1
PRESS REDUCING COUPLINGS				
739027	450-529P	3/4" x 1/2"	REDUCING COUPLING—PRESS x PRESS	10
739028	450-533P	1" x 3/4"	<i>Same as above</i>	10
739237	450-537P	1-1/4" x 1"	<i>Same as above</i>	1
PRESS REPAIR COUPLINGS				
739029	450-583P	1/2"	REPAIR COUPLING—PRESS x PRESS	10
739030	450-584P	3/4"	<i>Same as above</i>	10
739031	450-585P	1"	<i>Same as above</i>	5
739032	450-586P	1-1/4"	<i>Same as above</i>	1
739033	450-587P	1-1/2"	<i>Same as above</i>	1
739034	450-588P	2"	<i>Same as above</i>	1

FOR ADDITIONAL INFORMATION, VISIT THE LEGEND WEBSITE AT www.legendvalve.com

LEGEND

COPPER PRESS VALVES & FITTINGS



ID ORDER#	MODEL#	SIZE	DESCRIPTION	CTN QTY
PRESS DIELECTRIC UNIONS				* = SPECIAL ORDER ITEM
743780	301-103PNL	1/2"	PRESS DIELECTRIC UNION (P-571NL SERIES)—FNPT X PRESS , lead free	1
745526	301-104PNL	3/4"	<i>Same as above</i>	1
745527	301-105PNL	1"	<i>Same as above</i>	1
745610	301-106PNL	1-1/4"	<i>Same as above</i>	1
745613	301-123PNL	3/4 x 1/2"	<i>Same as above</i>	1
745616	301-204PNL	3/4"	<i>Same as above, but <u>MNPT x PRESS</u></i>	1
PRESS ELBOWS				
738997	450-023P	1/2"	45° LONG-TURN ELBOW—PRESS x PRESS	10
738998	450-024P	3/4"	<i>Same as above</i>	10
738999	450-025P	1"	<i>Same as above</i>	5
739000	450-026P	1-1/4"	<i>Same as above</i>	1
739001	450-027P	1-1/2"	<i>Same as above</i>	1
739002	450-028P	2"	<i>Same as above</i>	1
738989	450-003P	1/2"	90° LONG-TURN ELBOW—PRESS x PRESS	10
738990	450-004P	3/4"	<i>Same as above</i>	10
738991	450-005P	1"	<i>Same as above</i>	5
738994	450-006P	1-1/4"	<i>Same as above</i>	1
738995	450-007P	1-1/2"	<i>Same as above</i>	1
738996	450-008P	2"	<i>Same as above</i>	1
739094	450-063P	1/2"	45° STREET ELBOW—PRESS x FITTING	10
739095	450-064P	3/4"	<i>Same as above</i>	10
739096	450-065P	1"	<i>Same as above</i>	5
739097	450-066P	1-1/4"	<i>Same as above</i>	1
739098	450-067P	1-1/2"	<i>Same as above</i>	1
739099	450-068P	2"	<i>Same as above</i>	1
739080	450-043P	1/2"	90° STREET ELBOW—PRESS x FITTING	10
739081	450-044P	3/4"	<i>Same as above</i>	10
739082	450-045P	1"	<i>Same as above</i>	5
739083	450-046P	1-1/4"	<i>Same as above</i>	1
739084	450-047P	1-1/2"	<i>Same as above</i>	1
739085	450-048P	2"	<i>Same as above</i>	1
PRESS DROP EAR ELBOWS				
739288	450-803P	1/2"	90° DROP EAR ELBOW—PRESS X FNPT	10

FOR ADDITIONAL INFORMATION, VISIT THE LEGEND WEBSITE AT www.legendvalve.com

LEGEND

COPPER PRESS VALVES & FITTINGS



ID ORDER#	MODEL#	SIZE	DESCRIPTION	CTN QTY
PRESS EPDM O-RINGS				* = SPECIAL ORDER ITEM
739347	450-991P	1/2"	EPDM O-RING , bag of 3	1
739348	450-992P	3/4"	Same as above	1
739349	450-993P	1"	Same as above	1
739351	450-994P	1-1/4"	Same as above	1
PRESS TEES				
739003	450-153P	1/2"	TEE—PRESS x PRESS x PRESS	10
739004	450-154P	3/4"	Same as above	10
739005	450-155P	1"	Same as above	5
739006	450-156P	1-1/4"	Same as above	1
739007	450-157P	1-1/2"	Same as above	1
739008	450-158P	2"	Same as above	1
739122	450-203P	1" x 1/2" x 3/4"	REDUCING TEE—PRESS x PRESS x PRESS	5
739123	450-204P	1" x 1/2" x 1"	Same as above	5
739124	450-205P	1" x 3/4" x 1/2"	Same as above	5
739125	450-206P	1" x 3/4" x 3/4"	Same as above	5
739126	450-207P	1" x 3/4" x 1"	Same as above	5
739009	450-208P	3/4" x 3/4" x 1/2"	Same as above	10
739010	450-211P	1" x 1" x 1/2"	Same as above	5
739011	450-212P	1" x 1" x 3/4"	Same as above	5
739127	450-214P	1-1/4" x 1-1/4" x 1/2"	Same as above	1
739012	450-215P	1-1/4" x 1-1/4" x 3/4"	Same as above	1
739128	450-216P	1-1/4" x 1-1/4" x 1"	Same as above	1
739013	450-220P	1-1/2" x 1-1/2" x 1"	Same as above	1
739132	450-221P	1-1/2" x 1-1/2" x 1-1/4"	Same as above	1
739014 *	450-225P	2" x 2" x 1"	Same as above	1
739135	450-226P	2" x 2" x 1-1/4"	Same as above	1
739136	450-227P	2" x 2" x 1-1/2"	Same as above	1
739139	450-233P	1-1/4" x 3/4" x 3/4"	Same as above	1
739141	450-235P	1-1/4" x 3/4" x 1-1/4"	Same as above	1
739143	450-237P	1-1/4" x 1" x 3/4"	Same as above	1
739144	450-238P	1-1/4" x 1" x 1"	Same as above	1
739145	450-250P	3/4" x 1/2" x 1/2"	Same as above	10
739146	450-251P	3/4" x 1/2" x 3/4"	Same as above	1
739148	450-254P	1-1/2" x 1" x 1"	Same as above	1
739149	450-256P	1-1/2" x 1 x 1-1/2"	Same as above	1
739152	450-260P	1-1/2" x 1-1/4" x 1	Same as above	1
739153	450-261P	1-1/2" x 1-1/4" x 1-1/4"	Same as above	1
739154	450-273P	2" x 1-1/4" x 1-1/4"	Same as above	1
739156	450-278P	2" x 1-1/2" x 1"	Same as above	1
739157	450-279P	2" x 1-1/2" x 1-1/4"	Same as above	1
739158	450-280P	2" x 1-1/2" x 1-1/2"	Same as above	1

FOR ADDITIONAL INFORMATION, VISIT THE LEGEND WEBSITE AT www.legendvalve.com

LEGEND

COPPER PRESS VALVES & FITTINGS



ID ORDER#	MODEL#	SIZE	DESCRIPTION	CTN QTY
PRESS TEES				
739204	450-377P	3/4" x 3/4 x 3/4"	REDUCING TEE—PRESS x PRESS x FNPT	5
739206	450-381P	1" x 1" x 3/4"	<i>Same as above</i>	5
PRESS UNIONS				
739290	450-813P	1/2"	UNION—PRESS , DZR forged brass, no lead	10
739291	450-814P	3/4"	<i>Same as above</i>	10
739292	450-815P	1"	<i>Same as above</i>	10
739293	450-816P	1-1/4"	<i>Same as above</i>	6
739294	450-817P	1-1/2"	<i>Same as above</i>	4
PRESS VALVES				
670102	107-543PNL	1/2"	#R-670NL BOILER DRAIN VALVE—PRESS x MGHT , 1/4 turn, lead free	10
773171	107-544PNL	3/4"	<i>Same as above</i>	10

FOR ADDITIONAL INFORMATION, VISIT THE LEGEND WEBSITE AT www.legendvalve.com

LEGEND PUSH FITTING SYSTEM



	ID ORDER#	MODEL#	SIZE	DESCRIPTION	CTN QTY
BALL VALVES					
	637955	456-003NL	1/2" x 1/2"	BALL VALVE , forged brass, lead-free, full port, tested to 200 psi at 200°F, includes tube stiffeners	10
	637956	456-004NL	3/4" x 3/4"	<i>Same as above</i>	10
COUPLINGS					
	637951	456-523NL	1/2" x 1/2"	PUSH-FIT COUPLING , forged brass, lead-free, includes tube stiffeners	20
	642001	456-524NL	3/4" x 1/2"	<i>Same as above</i>	15
	637952	456-525NL	3/4" x 3/4"	<i>Same as above</i>	15
DISCONNECT TOOL					
	637959	456-803NL	1/2"	DISCONNECT TOOL , forged brass, lead-free	100
	637961	456-804NL	3/4"	<i>Same as above</i>	100
ELBOWS					
	641993	456-053NL	1/2" x 1/2"	PUSH-FIT x PUSH-FIT ELBOW , forged brass, lead-free, includes tube stiffeners	20
	641704	456-054NL	3/4" x 3/4"	<i>Same as above</i>	15
TEES					
	641985	456-180NL	1/2" x 1/2" x 1/2"	PUSH-FIT TEE , forged brass, lead-free, includes tube stiffeners	20
	641988	456-184NL	3/4" x 3/4" x 1/2"	<i>Same as above</i>	15
	641703	456-186NL	3/4" x 3/4" x 3/4"	<i>Same as above</i>	15
TEST CAPS					
	637957	456-483NL	1/2"	PUSH-FIT TEST CAP , forged brass, lead-free	30
	637958	456-484NL	3/4"	<i>Same as above</i>	20
THREAD ADAPTERS					
	637953	456-753NL	1/2" x 1/2"	MIP x PUSH-FIT THREAD ADAPTER , forged brass, lead-free, includes tube stiffeners	20
	637954	456-755NL	3/4" x 3/4"	<i>Same as above</i>	15

FOR ADDITIONAL INFORMATION, VISIT THE LEGEND WEBSITE AT www.legend.com

LEGEND

CHROME NIPPLES & FITTINGS



ID ORDER#	MODEL#	SIZE	DESCRIPTION	CTN QTY
2727 *	310-022CP	3/8"	45° ELBOW , cast brass, chrome-plated	75
672709	310-002CP	3/8"	90° ELBOW , cast brass, chrome-plated	25
672710 *	310-003CP	1/2"	<i>Same as above</i>	25
2728	311-041CNL	3/8" x 1-1/2"	NIPPLE , cast brass, chrome-plated	25
2729	311-042CNL	3/8" x 2"	<i>Same as above</i>	25
2730	311-043CNL	3/8" x 2-1/2"	<i>Same as above</i>	25
2731	311-044CNL	3/8" x 3"	<i>Same as above</i>	25
2732	311-045CNL	3/8" x 3-1/2"	<i>Same as above</i>	25
2733	311-046CNL	3/8" x 4"	<i>Same as above</i>	25
2734	311-047CNL	3/8" x 4-1/2"	<i>Same as above</i>	25
2735	311-048CNL	3/8" x 5"	<i>Same as above</i>	25
2736	311-049CNL	3/8" x 5-1/2"	<i>Same as above</i>	25
2737	311-050CNL	3/8" x 6"	<i>Same as above</i>	25
2738	311-060CNL	1/2" x Close	<i>Same as above</i>	25
2739	311-061CNL	1/2" x 1-1/2"	<i>Same as above</i>	25
2740	311-062CNL	1/2" x 2"	<i>Same as above</i>	25
2741	311-063CNL	1/2" x 2-1/2"	<i>Same as above</i>	25
2742	311-064CNL	1/2" x 3"	<i>Same as above</i>	25
2743	311-065CNL	1/2" x 3-1/2"	<i>Same as above</i>	25
2744	311-066CNL	1/2" x 4"	<i>Same as above</i>	25
2745	311-067CNL	1/2" x 4-1/2"	<i>Same as above</i>	25
2746	311-068CNL	1/2" x 5"	<i>Same as above</i>	25
17857	311-069CNL	1/2" x 5-1/2"	<i>Same as above</i>	25
2747	311-070CNL	1/2" x 6"	<i>Same as above</i>	25

* = SPECIAL ORDER ITEM

FOR ADDITIONAL INFORMATION, VISIT THE LEGEND WEBSITE AT www.legendvalve.com

LEGEND BRASS THREADED NIPPLES & FITTINGS



ID ORDER#	MODEL#	SIZE	DESCRIPTION	CTN QTY
BRASS THREADED NIPPLES				* = SPECIAL ORDER ITEM
721830	311-020	1/4" x Close	NIPPLE , cast brass, lead-free	25
721829	311-024	1/4" x 3"	<i>Same as above</i>	25
721828	311-030	1/4" x 6"	<i>Same as above</i>	25
62113	311-040	3/8" x close	<i>Same as above</i>	25
62053	311-044	3/8" x 3"	<i>Same as above</i>	25
62064 *	311-050	3/8" x 6"	<i>Same as above</i>	25
62066	311-060	1/2" x close	<i>Same as above</i>	25
62071	311-064	1/2" x 3"	<i>Same as above</i>	25
62077	311-070	1/2" x 6"	<i>Same as above</i>	25
62079	311-080	3/4" x close	<i>Same as above</i>	25
62080	311-081	3/4" x 1-1/2"	<i>Same as above</i>	25
62082	311-082	3/4" x 2"	<i>Same as above</i>	25
62083	311-083	3/4" x 2-1/2"	<i>Same as above</i>	25
62084	311-084	3/4" x 3"	<i>Same as above</i>	25
62085	311-085	3/4" x 3-1/2"	<i>Same as above</i>	25
62086	311-086	3/4" x 4"	<i>Same as above</i>	25
62090	311-090	3/4" x 6"	<i>Same as above</i>	25
721859	311-102	1" x 2"	<i>Same as above</i>	25
234883	311-104	1" x 3"	<i>Same as above</i>	25
721860	311-106	1" x 4"	<i>Same as above</i>	25
721861	311-110	1" x 6"	<i>Same as above</i>	25
444077	311-124	1-1/4" x 3"	<i>Same as above</i>	10
444081	311-144	1-1/2" x 3"	<i>Same as above</i>	10
182828	311-146	1-1/2" x 4"	<i>Same as above</i>	10
BRASS THREADED FITTINGS				
741286	313-124NL	3/4"	METER COUPLING—MNPT X AWWA , cast brass, lead-free	20
741287	313-125NL	1"	<i>Same as above</i>	10

FOR ADDITIONAL INFORMATION, VISIT THE LEGEND WEBSITE AT www.legendvalve.com

LEGEND

BRONZE THREADED FITTINGS



ID ORDER#	MODEL#	SIZE	DESCRIPTION	CTN QTY
721923	310-123NL	1/2"	CAP , cast bronze, lead-free	25
747234	310-124NL	3/4"	<i>Same as above</i>	25
672705	310-084NL	3/4"	COUPLING , cast bronze, lead-free	25
610782	310-085NL	1"	<i>Same as above</i>	25
721832	310-372NL	1" - 3/4"	COUPLING , cast bronze, lead-free	25
721833	310-375NL	1-1/4" - 3/4"	<i>Same as above</i>	25
721834	310-024NL	3/4"	45° ELBOW , cast bronze, lead-free	25
721857	310-025NL	1"	<i>Same as above</i>	25
672704	310-004NL	3/4"	90° ELBOW , cast bronze, lead-free	25
721831	310-005NL	1"	<i>Same as above</i>	25
672708	310-479NL	3/4" x 1/2"	HEX BUSHING , cast bronze, lead-free	25
713636	310-483NL	1" x 3/4"	<i>Same as above</i>	25
721858	310-487NL	1-1/4" x 1"	<i>Same as above</i>	25
721959	310-183NL	1/2"	SQUARE HEAD PLUG , cast bronze, lead-free	25
672707	310-104NL	3/4"	TEE , cast bronze, lead-free	25
649533	310-105NL	1"	<i>Same as above</i>	10
721836	310-144NL	3/4"	UNION , cast bronze, lead-free	25
721835	310-145NL	1"	<i>Same as above</i>	25

FOR ADDITIONAL INFORMATION, VISIT THE LEGEND WEBSITE AT www.legendvalve.com

LEGEND VALVES



ID ORDER#	MODEL#	SERIES#	SIZE	DESCRIPTION	CTN QTY
672645	114-146NL	S-581LSNL	1/2" x 3/8"	ANGLE STOP VALVE , sweat x COMP, multi-turn, chrome brass, lead free	10
672644	114-144NL	T-581LSNL	5/8" x 3/8"	ANGLE STOP VALVE , COMP x COMP, multi-turn, chrome brass, lead free	10
723238	114-602NL	T-595NL	3/8" x 3/8"	ANGLE VALVE , FIP x COMP, lead free	5
715639	114-615NL	T-595NL	1/2" x 1/4"	ANGLE VALVE , PEX x COMP, lead free	5
672239	114-609NL	T-595NL	1/2" x 3/8"	<i>Same as above</i>	5
672237	114-613NL	T-595NL	1/2" x 3/8"	ANGLE VALVE , sweat x COMP, lead free	5
672238	114-604NL	T-595NL	5/8" x 3/8"	ANGLE VALVE , comp x COMP, lead free	5
726248	202-263	S-641	3"	BACKWATER VALVE—PVC , with sleeve and cap	1
726249	202-264	S641	4"	<i>Same as above</i>	1
670099	101-585NL	T-806NL	1/2"	BALL VALVE , PEX x PEX, lead free	10
670100	101-586NL	T-806NL	3/4"	<i>Same as above</i>	10
670101	101-587NL	T-806NL	1"	<i>Same as above</i>	5
672664	101-643NL	T-1009NL	1/2"	BALL VALVE , C x C, lead free	10
672665	101-644NL	T-1009NL	3/4"	<i>Same as above</i>	10
693903	101-413NL	T-2000NL	1/2"	BALL VALVE , IP, blue handle, lead free	10
693904	101-414NL	T-2000NL	3/4"	<i>Same as above</i>	8
693905	101-415NL	T-2000NL	1"	<i>Same as above</i>	6
693906	101-416NL	T-2000NL	1-1/4"	<i>Same as above</i>	6
693907	101-417NL	T-2000NL	1-1/2"	<i>Same as above</i>	4
693908	101-418NL	T-2000NL	2"	<i>Same as above</i>	2
670907	101-419NL	T-2000NL	2-1/2"	<i>Same as above</i>	2
671160	101-420NL	T-2000NL	3"	<i>Same as above</i>	2

FOR ADDITIONAL INFORMATION, VISIT THE LEGEND WEBSITE AT www.legendvalve.com

LEGEND VALVES



ID ORDER#	MODEL#	SERIES#	SIZE	DESCRIPTION	CTN QTY
762642	101-423NL	S-2000NL	1/2"	BALL VALVE , C x C, lead free (=American Valve #G100S)	10
762643	101-424NL	S-2000NL	3/4"	<i>Same as above</i>	8
762644	101-425NL	S-2000NL	1"	<i>Same as above</i>	6
695548	101-426NL	S-2000NL	1-1/4"	<i>Same as above</i> (=American Valve #G100S)	6
767708	101-427NL	S-2000NL	1-1/2"	<i>Same as above</i> (=American Valve #G100S)	4
699345	101-428NL	S-2000NL	2"	<i>Same as above</i>	8
684134	101-429NL	S-2000NL	2-1/2"	<i>Same as above</i>	4
684136	101-430NL	S-2000NL	3"	<i>Same as above</i>	2
29021	102-513	T-3100	1/2"	BALL VALVE—GAS COCK WITH NPT SIDE TAP , forged brass	10
29022	102-514	T-3100	3/4"	<i>Same as above</i>	10
73803	102-103	T-3000	1/2"	BALL VALVE—GAS COCK LESS NPT SIDE TAP , forged brass	10
73800	102-104	T-3000	3/4"	<i>Same as above</i>	10
670102	107-543NL	R-670NL	1/2"	BOILER DRAIN VALVE , MIP or C x C, 1/4 turn, lead free	10
670103	107-544NL	R-670NL	3/4"	<i>Same as above</i> , but MIP only	10
850	107-143	T-521	1/2"	BOILER DRAIN VALVE , MIP or C x C	10
853	107-144	T-521	3/4"	<i>Same as above</i> , but MIP only	10
672623	105-423NL	T-450NL	1/2"	CHECK VALVE—IN-LINE , FNPT x FNPT, bronze, lead free	1
672624	105-424NL	T-450NL	3/4"	<i>Same as above</i>	1
672626	105-425NL	T-450NL	1"	<i>Same as above</i>	1
669312	105-203NL	S-451NL	1/2"	CHECK VALVE—SWING , C x C, lead free, 200 CWP	25
669314	105-204NL	S-451NL	3/4"	<i>Same as above</i>	20
669315	105-205NL	S-451NL	1"	<i>Same as above</i>	12
669316	105-206NL	S-451NL	1-1/4"	<i>Same as above</i>	8
669317	105-207NL	S-451NL	1-1/2"	<i>Same as above</i>	6
669318	105-208NL	S-451NL	2"	<i>Same as above</i>	3
768030	105-103NL	T-451NL	1/2"	CHECK VALVE—SWING , IP, lead free, 200 CWP	25
768031	105-104NL	T-451NL	3/4"	<i>Same as above</i>	20
768035	105-105NL	T-451NL	1"	<i>Same as above</i>	15
768036 *	105-106NL	T-451NL	1-1/4"	<i>Same as above</i>	8
768037 *	105-107NL	T-451NL	1-1/2"	<i>Same as above</i>	6
768038 *	105-108NL	T-451NL	2"	<i>Same as above</i>	3

* = SPECIAL ORDER ITEM

FOR ADDITIONAL INFORMATION, VISIT THE LEGEND WEBSITE AT www.legendvalve.com

LEGEND VALVES



ID ORDER#	MODEL#	SERIES#	SIZE	DESCRIPTION	CTN QTY
693275	105-405NL	S-453NL	1"	CHECK VALVE—Y PATTERN , C x C, bronze, lead free, with stainless steel strainer	12
693276	105-406NL	S-453NL	1-1/4"	<i>Same as above</i>	12
672640	111-133NL	T-11NL	1/2"	DUO-CLOZ VALVE , MIP, lead free	1
672641	111-134NL	S-11NL	1/2"	DUO-CLOZ VALVE , C x C, lead free	1
672218	104-703NL	T-408NL	1/2"	GATE VALVE , IP, lead free	10
672221	104-704NL	T-408NL	3/4"	<i>Same as above</i>	10
672222	104-705NL	T-408NL	1"	<i>Same as above</i>	5
672223	104-706NL	T-408NL	1-1/4"	<i>Same as above</i>	5
672224	104-707NL	T-408NL	1-1/2"	<i>Same as above</i>	5
672227	104-708NL	T-408NL	2"	<i>Same as above</i>	2
672228	104-723NL	S-408NL	1/2"	GATE VALVE , C x C, lead free	10
672230	104-724NL	S-408NL	3/4"	<i>Same as above</i>	10
672231	104-725NL	S-408NL	1"	<i>Same as above</i>	5
672232	104-726NL	S-408NL	1-1/4"	<i>Same as above</i>	5
672233	104-727NL	S-408NL	1-1/2"	<i>Same as above</i>	5
672234	104-728NL	S-408NL	2"	<i>Same as above</i>	2
738477	110-104	T-431	3/4"	RADIATOR VALVE , IP, FNPT x MNPT, bronze	8
738478	110-105	T-431	1"	<i>Same as above</i>	6
738479	110-106	T-431	1-1/4"	<i>Same as above</i>	4
768993	107-133NL	S-511NL	1/2"	STOP & WASTE VALVE , C x C, lead free	10
768996 *	107-134NL	S-511NL	3/4"	<i>Same as above</i>	10
723237	114-702NL	T-596NL	3/8" x 3/8"	STRAIGHT VALVE , FIP x COMP, lead free	5
672243	114-709NL	T-596NL	1/2" x 3/8"	STRAIGHT VALVE , PEX x comp, lead free	5
672240	114-713NL	T-596NL	1/2" x 3/8"	STRAIGHT VALVE , sweat x comp, lead free	5
672241	114-704NL	T-596NL	5/8" x 3/8"	STRAIGHT VALVE , comp x comp, lead free	5

* = SPECIAL ORDER ITEM

FOR ADDITIONAL INFORMATION, VISIT THE LEGEND WEBSITE AT www.legendvalve.com

LEGEND

DIELECTRIC UNIONS & NIPPLES



ID ORDER#	MODEL#	SERIES#	SIZE	DESCRIPTION	CTN QTY
672263	301-103NL	T-571NL	1/2"	DIELECTRIC UNION , female x sweat, forged steel, lead free	12
672053	301-104NL	T-571NL	3/4"	<i>Same as above</i>	12
672256	301-105NL	T-571NL	1"	<i>Same as above</i>	12
672265	301-106NL	T-571NL	1-1/4"	<i>Same as above</i>	6
672266	301-107NL	T-571NL	1-1/2"	<i>Same as above</i>	6
672267	301-108NL	T-571NL	2"	<i>Same as above</i>	6
672264	301-123NL	T-571NL	3/4" x 1/2"	DIELECTRIC UNION , female x sweat, forged steel, lead free	12
672269	301-204NL	T-571NL	3/4" x 3/4"	DIELECTRIC UNION , male x sweat, forged steel, lead free	12
743780	301-103PNL	P-571NL	1/2"	DIELECTRIC UNION—PRESS , female x press, lead free	1
745526	301-104PNL	P-571NL	3/4"	<i>Same as above</i>	1
745527	301-105PNL	P-571NL	1"	<i>Same as above</i>	1
745610	301-106PNL	P-571NL	1-1/4"	<i>Same as above</i>	1
745613	301-123PNL	P-571NL	3/4" x 1-1/2"	<i>Same as above</i>	1
745616	301-204PNL	P-571NL	3/4"	DIELECTRIC UNION—PRESS , male x press, lead free	1
234123	301-434	--	3/4"	DIELECTRIC UNION STEAM GASKET , ECO rubber, 275°F maximum temperature	1
234124	301-435	--	1"	<i>Same as above</i>	1
2397	301-403	--	1/2"	DIELECTRIC UNION GASKET , EPDM rubber	1
2398	301-404	--	3/4"	<i>Same as above</i>	1
2400	301-405	--	1"	<i>Same as above</i>	1
2401	301-406	--	1-1/4"	<i>Same as above</i>	1
2402	301-407	--	1-1/2"	<i>Same as above</i>	1
2403	301-408	--	2"	<i>Same as above</i>	1
441808	301-506	T-575	1-1/2" x 4"	DIELECTRIC NIPPLE , male, galvanized	1

FOR ADDITIONAL INFORMATION, VISIT THE LEGEND WEBSITE AT www.legendvalve.com

LEGEND MISCELLANEOUS



ID ORDER#	MODEL#	SERIES#	SIZE	DESCRIPTION	CTN QTY
2405	303-407	--	1-1/2"	COUPLINGS—NO HUB (=Jones #U95-001)	100
2406	303-408	--	2"	<i>Same as above</i> (=Jones #U95-002)	100
2407	303-410	--	3"	<i>Same as above</i> (=Jones #U95-003)	100
2408	303-411	--	4"	<i>Same as above</i> (=Jones #U95-004)	100
738480	110-164	T-438	3/4"	RADIATOR 90° UNION ELBOW , IP, FNPT, bronze	10
773978	107-184	S-541L	1/2"	SILLCOCK , CxH, brass, 125 CWP	10
669321	107-174NL	T-541NL	1/2"	SILLCOCK , IP, lead free	10
669322	107-175NL	T-541NL	3/4"	<i>Same as above</i>	10
773978	107-184	S-541L	1/2"	SILLCOCK , CxH, brass, 125 CWP	10
685737	108-155A	T-550	1/2" x 12"	SILLCOCK—FROST FREE , MNPT or sweat, 1/4 turn	1
693641	302-203	T-570	3/4" x 1/2"	TEE—MONO-FLOW , sweat, bronze (=B&G #108119)	40
693645	302-207	T-570	1-1/4" x 3/4"	<i>Same as above</i> , (=B&G #108123)	20
86033	107-196	T-554	3/4"	VACUUM BREAKER , brass, manual drain	20
707087	900-050	--	--	WASTE CAP , fits most drainable valves	10
672638	105-503NL	T-15NL	1/2"	Y STRAINER , FNPT, bronze, lead free	12
672639	105-504NL	T-15NL	3/4"	<i>Same as above</i>	8
672634	105-505NL	T-15NL	1"	<i>Same as above</i>	8
672636	105-506NL	T-15NL	1-1/4"	<i>Same as above</i>	6
672635	105-507NL	T-15NL	1-1/2"	<i>Same as above</i>	2
672637	105-508NL	T-15NL	2"	<i>Same as above</i>	2
672630	105-513NL	S-15NL	1/2"	Y STRAINER , C x C, bronze, lead free	10
238030	105-514NL	S-15NL	3/4"	<i>Same as above</i>	8
218308	105-515NL	S-15NL	1"	<i>Same as above</i>	8
218309	105-516NL	S-15NL	1-1/4"	<i>Same as above</i>	8
218310	105-517NL	S-15NL	1-1/2"	<i>Same as above</i>	2
216936	105-518NL	S-15NL	2"	<i>Same as above</i>	2

FOR ADDITIONAL INFORMATION, VISIT THE LEGEND WEBSITE AT www.legendvalve.com







ID ORDER#	MODEL #	SIZE	COLOR	DESCRIPTION	CTN QTY
731793	665X8W100	1/8" x 100'	White	COLD WATER POLYETHYLENE PIPE—100' COIL	1
757128	664X2W20	1/2" x 10'	White	NON-BARRIER PEX PIPE—10' STRAIGHT LENGTH	50
757126	664X2B20	1/2" x 10'	Blue	Same as above	50
757127	664X2R20	1/2" x 10'	Red	Same as above	50
757131	664X3W20	3/4" x 10'	White	Same as above	25
757129	664X3B20	3/4" x 10'	Blue	Same as above	25
757130	664X3R20	3/4" x 10'	Red	Same as above	25
757134	664X4W20	1" x 10'	White	Same as above	15
458781	500-12-20	1/2" x 20'	White	NON-BARRIER PEX PIPE—20' STRAIGHT LENGTH	25
558026	500-12-20B	1/2" x 20'	Blue	Same as above	25
558025	500-12-20R	1/2" x 20'	Red	Same as above	25
458782	500-34-20	3/4" x 20'	White	Same as above	25
558027	500-34-20B	3/4" x 20'	Blue	Same as above	25
558023	500-34-20R	3/4" x 20'	Red	Same as above	25
468171	500-10-20	1" x 20'	White	Same as above	15
458744	665X2W100	1/2" x 100'	White	NON-BARRIER PEX PIPE—100' COIL	1
700002	665X2B100	1/2" x 100'	Blue	Same as above	1
700001	665X2R100	1/2" x 100'	Red	Same as above	1
458748	665X3W100	3/4" x 100'	White	Same as above	1
700004	665X3B100	3/4" x 100'	Blue	Same as above	1
700003	665X3R100	3/4" x 100'	Red	Same as above	1
468172	665X4W100	1" x 100'	White	Same as above	1
458746	665X2W500	1/2" x 500'	White	NON-BARRIER PEX PIPE—500' COIL	1
458750	665X3W500	3/4" x 500'	White	Same as above	1

FOR ADDITIONAL INFORMATION, VISIT THE SIOUX CHIEF & LEGEN VALVE WEBSITES AT www.siouxchief.com and www.legendvalve.com

SIoux CHIEF COPPER PEX FITTINGS









	ID ORDER#	MODEL #	SIZE	DESCRIPTION	CTN QTY
	632618	643X2	1/2" x 1/2"	ADAPTER—MALE SWEAT x BARB , copper	100
	632620	643X3	3/4" x 3/4"	<i>Same as above</i>	50
	632622	643X4	1" x 1"	<i>Same as above</i>	25
	632619	644X2	1/2" x 1/2"	ADAPTER—FEMALE SWEAT x BARB , copper	100
	632623	644X32	3/4" x 1/2"	<i>Same as above</i>	50
	632624	644X3	3/4" x 3/4"	<i>Same as above</i>	50
	632625	644X4	1" x 1"	<i>Same as above</i>	25
	458979	649X2	1/2"	CRIMP RING , copper	100
	458980	649X3	3/4"	<i>Same as above</i>	100
	468417	649X4	1"	<i>Same as above</i>	25
	468174 *	649X5	1-1/4"	<i>Same as above</i>	25
	632789	645X2GPK2	1/2"	COUPLING KIT—TRANSITION , 1/2" O.D. PEX x 1/2" O.D. polybutylene, with copper crimp rings	10
	632793	645X3GPK2	3/4"	<i>Same as above</i> , but with 3/4" O.D. PEX x 3/4" O.D. polybutylene	10
	623768	647XG2E3	1/2" x 1/2"	ELBOW—DROP EAR , copper, 1/2" barb x 1/2" FPT (=647XG2E)	50
	747224	630X248E	1/2" x 1/2"	STUB-OUT , copper, 8" elbow, 1/2" barb x 1/2" nominal with nailing flange/ear	50
	458957	638X212	1/2" x 1/2"	<i>Same as above</i> , but 12" straight	100

* = SPECIAL ORDER ITEM

FOR ADDITIONAL INFORMATION, VISIT THE SIOUX CHIEF WEBSITE AT www.siouxchief.com

SIoux CHIEF BRASS PEX FITTINGS







	ID ORDER#	MODEL #	SIZE	DESCRIPTION	CTN QTY
	458913	643XG32	3/4" x 1/2"	ADAPTER—MALE SWEAT x BARB , brass	50
	632637	646XG2	1/2" x 1/2"	ADAPTER—MIP x PEX MALE , brass	100
	632638	646XG32	3/4" x 1/2"	Same as above	50
	632640	646XG3	3/4" x 3/4"	Same as above	25
	633206	646XG4	1" x 1"	Same as above	50
	623770	647XG2	1/2" x 1/2"	ADAPTER—BARB x FPT NON-SWIVEL , brass	50
	623771	647XG3	3/4" x 3/4"	Same as above	50
	633208	647XG4	1" x 1"	Same as above	50
	632701	645XG2	1/2"	COUPLING—BARB , brass	100
	632702	645XG3	3/4"	Same as above	50
	632786	645XG32	3/4" x 1/2"	Same as above	50
	632788	645XG4	1"	Same as above	25
	632787	645XG43	1" x 3/4"	Same as above	25
	632635	644XG3	3/4" x 3/4"	ELBOW—BRASS , 3/4" female sweat x 3/4" brass barb	50
	632626	642XG2	1/2"	ELBOW—BARB , brass	25
	632630	642XG3	3/4"	Same as above	25
	632628	642XG23	3/4" x 1/2"	Same as above	25
	632634	642XG4	1"	Same as above	25
	632642	641XG222	1/2"	TEE—BARB , brass	50
	632646	641XG333	3/4"	Same as above	20
	632643	641XG322	3/4" x 1/2" x 1/2"	Same as above	20
	632644	641XG323	3/4" x 1/2" x 3/4"	Same as above	20
	632645	641XG332	3/4" x 3/4" x 1/2"	Same as above	20
	632654	641XG444	1"	Same as above	20
	632648	QQT544GX	1" x 3/4" x 3/4"	Same as above (Zurn Pex / =641XG433PK1M)	25
	632652	641XG442	1" x 1" x 1/2"	Same as above	20
	632653	641XG443	1" x 1" x 3/4"	Same as above	20
	478253	640XG02	1/2"	TEST PLUG—BARB , brass	100
	623766	640XG03	3/4"	Same as above	100
	623767	640XG04	1"	Same as above	25

SIOUX CHIEF

POLYMER/PLASTIC PEX FITTINGS







	ID ORDER#	MODEL #	SIZE	DESCRIPTION	CTN QTY
	566845	550-PB2	1/2"	BEND GUIDE (SUPPORT) , polymer plastic (=Rehau #266207-001)	50
	558030	550-PB3	3/4"	Same as above (=Rehau #266227-001)	50
	458996	645PX2	1/2"	COUPLING—BARB , polymer	25
	458998	645PX3	3/4"	Same as above	25
	715907	645PX32	3/4" x 1/2"	Same as above	25
	725499	645PX4	1"	Same as above	25
	733873	645PX43	1" x 3/4"	Same as above	25
	459004	642PX2	1/2"	ELBOW—BARB , polymer	25
	459008	642PX3	3/4"	Same as above	25
	713251	642PX4	1"	Same as above	25
	459016	641PX222	1/2"	TEE—BARB , polymer	50
	459021	641PX333	3/4"	Same as above	20
	459018	641PX322	3/4" x 1/2" x 1/2"	Same as above	20
	459019	641PX323	3/4" x 1/2" x 3/4"	Same as above	20
	459020	641PX332	3/4" x 3/4" x 1/2"	Same as above	20
	713264	641PX444	1"	Same as above	20
	733871	641PX433	1" x 3/4" x 3/4"	Same as above	20
	733872	641PX443	1" x 1" x 3/4"	Same as above	20
	458967	640PX12	1/2"	TEST PLUG—BARB , plastic	50
	458968	640PX13	3/4"	Same as above	25

FOR ADDITIONAL INFORMATION, VISIT THE SIOUX CHIEF WEBSITE AT www.siouxchief.com

SIOUX CHIEF PEX ACCESSORIES & TOOLS



	ID ORDER#	MODEL #	SIZE	DESCRIPTION	CTN QTY
	478257	305-999	1/2" - 1"	CRIMP REMOVAL TOOL	1
	459342	305-7120	1/2"	CRIMP TOOL—MEDIUM	1
	459344	305-7130	3/4"	<i>Same as above</i>	1
	468173	305-7040	1"	<i>Same as above</i>	1
	459316	555-2	1/2"	J-HOOK CLAMP , with nails	100
	459317	555-3	3/4"	<i>Same as above</i>	100
	468182	555-4	1"	<i>Same as above</i>	100
	767435	305-995	1"	TEST GAUGE , F1807, for 3/8", 1/2", 5/8", 3/4" and 1" crimp rings	1
	568604	632X225	1/2" x 1/2"	TUB/SHOWER VALVE ELBOW , copper, 1/2" barb x 1/2" female sweat	100
	650730	634X418	3/4" x 3/4"	WATER HEATER CONNECTOR , less valve, 3/4" PEX x 3/4" FIP swivel, lead free	10

* = SPECIAL ORDER ITEM

FOR ADDITIONAL INFORMATION, VISIT THE SIOUX CHIEF WEBSITE AT www.siouxchief.com

DWV PVC & FOAMCORE
SEWER & DRAIN – PVC PRESSURE

SCHEDULE 30 PVC PIPE (Thinwall)

ID ORDER#	MODEL#	TYPE	SIZE
Note: Priced per 100'			
3954	60031	Plain End	3" x 10'

SCHEDULE 40 PVC PRESSURE PIPE

ID ORDER#	MODEL#	TYPE	SIZE
Note: Priced per 100'			
206226	SDR-21	--	3/4" x 10'

**SCHEDULE 40 PVC SOLVENT WELD
PRESSURE PIPE**, plain end, 200 psi,
class 200, for cold water use only,
acceptable for condensate drains 20.69

SCHEDULE 40 DWV PVC PIPE

ID ORDER#	MODEL#	TYPE	SIZE
Note: Priced per 100'			
4039	70011	Plain End	1-1/2" x 10'
4040	70021	Plain End	2" x 10'
4041	70031	Plain End	3" x 10'
4042	70041	Plain End	4" x 10'
4046	70061	Plain End	6" x 10'

SCHEDULE 40 DWV PVC FOAMCORE PIPE

ID ORDER#	MODEL#	TYPE	SIZE
Note: Priced per 100'			
153263	--	Plain End	1-1/2" x 10'
153264	--	Plain End	2" x 10'
153266	--	Plain End	3" x 10'
80286	--	Plain End	4" x 10'

SEWER & DRAIN PIPE

ID ORDER#	MODEL#	TYPE	SIZE
Note: Priced per 100'			
10659	40040	--	4" x 10'
10660	40066	--	6" x 10'

	ID	MODEL#	SIZE	CTN
	ORDER#	MODEL#	SIZE	QTY
COUPLING (HUB x HUB)				
	3955	60130	3"	20
	3956	60131	3" x 1-1/2"	25
	3957	60132	3" x 2"	20
	47277	60143	4" x 3"	20

REPAIR COUPLING (no stop) HUB x HUB				
	3958	60133	3"	20

CAP				
	3959	60153	3"	20

REDUCING BUSHINGS (SPIGOT x HUB)				
	3960	60231	3" x 1-1/2"	20
	3961	60232	3" x 2"	20

FEMALE ADAPTER (HUB x FPT)				
	3962	60330	3"	20

MALE ADAPTER (HUB x MPT)				
	3963	60430	3"	20

45° ELBOW (HUB x HUB)				
	3965	60630	3"	20

22-1/2° ELBOW (HUB x HUB)				
	3966	60830	3"	20

60° ELBOW (HUB x HUB)				
	3967	60930	3"	20

WYES (ALL HUB)				
	3968	61030	3"	20
	3969	61031	3" x 1-1/2"	20
	3970	61032	3" x 2"	20

SANITARY TEES (ALL HUB)				
	3971	61130	3"	20
	3972	61131	3" x 1-1/2"	20
	3973	61132	3" x 2"	20

TEST TEE (with plug) (H x H x FPT)				
	11864	61330	3"	10

FPT = Female Pipe Thread
MPT = Male Pipe Thread
IPS = Iron Pipe Size
SPIGOT = Pipe O.D. Size

ID	ORDER#	MODEL#	SIZE	CTN	QTY
----	--------	--------	------	-----	-----

FITTING CLEANOUT WITH #618 THREADED PLUG



3975	61630	3"	20
------	-------	----	----

45° STREET ELBOW (HUB x SPIGOT)



3982	62730	3"	20
------	-------	----	----

90° SANITARY ELBOW (HUB x HUB)



4011	62830	3"	20
------	-------	----	----

90° SANITARY STREET ELBOW (HUB x SPIGOT)



4012	62936	3"	20
------	-------	----	----

CLOSET FLANGE, POP TOP



4017	65134	4" x 3"	20
------	-------	---------	----

SCHEDULE 30 TO SCHEDULE 40 ADAPTER



4018	65330	3" x 3"	20
------	-------	---------	----

FPT = Female Pipe Thread
MPT = Male Pipe Thread
IPS = Iron Pipe Size
SPIGOT = Pipe O.D. Size

	ID	MODEL#	SIZE	CTN
	ORDER#	MODEL#	SIZE	QTY
COUPLINGS (HUB x HUB)				
	4047	70115	1-1/2"	100
	4048	70120	2"	100
	4049	70121	2" x 1-1/2"	25
	4050	70130	3"	60
	4051	70131	3" x 1-1/2"	25
	4052	70132	3" x 2"	20
	4053	70140	4"	25
	4054	70142	4" x 2"	10
	4055	70143	4" x 3"	10
	4056	70160	6"	15

REPAIR COUPLINGS (no stop) HUB x HUB

	4057	70116	1-1/2"	25
	4058	70122	2"	25
	4059	70133	3"	12
	4060	70144	4"	5

CAPS

4061	70151	1-1/2"	50
4062	70152	2"	50
4063	70153	3"	10
4064	70154	4"	5
56855	70156	6"	8

REDUCING FLUSH BUSHINGS (SPIGOT x HUB)

	4065	70221	2" x 1-1/2"	50
	4066	70231	3" x 1-1/2"	30
	4067	70232	3" x 2"	30
	4068	70242	4" x 2"	30
	4069	70243	4" x 3"	30
	4070	70264	6" x 4"	10
	172910 *	70286	8" x 6"	1

FEMALE ADAPTER (HUB x FPT)

	4071	70315	1-1/2"	100
	4072	70320	2"	100
	4073	70330	3"	30
	4075	70340	4"	10

* = SPECIAL ORDER ITEM

MALE ADAPTER (HUB x MPT)

	4076	70411	1-1/2" x 1-1/4"	100
	4077	70415	1-1/2"	50
	4078	70420	2"	50
	4079	70430	3"	25
	4080	70440	4"	25

45° ELBOW (HUB x HUB)

	4087	73615	1-1/2"	100
	4088	73620	2"	50
	4089	70630	3"	20
	4090	70640	4"	10
	4091	70660	6"	3

22-1/2° ELBOW (HUB x HUB)

	4099	70815	1-1/2"	50
	4100	70820	2"	25
	4101	70830	3"	20
	4102	70840	4"	15

60° ELBOW (HUB x HUB)

	4103	70915	1-1/2"	40
	4104	70920	2"	25
	4105	70930	3"	20
	4106	70940	4"	10

WYES (ALL HUB)

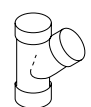
	4107	71015	1-1/2"	50
	4108	71020	2"	25
	4109	71021	2" x 2" x 1-1/2"	25
	4110	71030	3"	25
	4111	71031	3" x 3" x 1-1/2"	15
	4112	71032	3" x 3" x 2"	25
	4113	71040	4"	5
	4114 *	71041	4" x 4" x 1-1/2"	10
(NOTE: 4114 substitute=71042+70221)				
	4115	71042	4" x 4" x 2"	10
	4116	71043	4" x 4" x 3"	10
	4117	71060	6"	4
	4119	71064	6" x 6" x 4"	5

FPT = Female Pipe Thread
MPT = Male Pipe Thread
IPS = Iron Pipe Size
SPIGOT = Pipe O.D. Size

	ID	MODEL#	SIZE	CTN
	ORDER#	MODEL#	SIZE	QTY
SANITARY TEES (ALL HUB)				
	4120	71115	1-1/2"	100
	4121	71120	2"	35
	4123	71123	2" x 1-1/2" x 1-1/2"	25
	714345	71122	2" x 1-1/2" x 2"	25
	4122	71121	2" x 2" x 1-1/2"	50
	4124	71130	3"	30
	4125	71131	3" x 3" x 1-1/2"	20
	4126	71132	3" x 3" x 2"	10
	4127	71140	4"	5
	4129	71142	4" x 4" x 2"	10
	4130	71143	4" x 4" x 3"	10
	4131	71160	6" x 1"	4

	ID	MODEL#	SIZE	CTN
	ORDER#	MODEL#	SIZE	QTY
TEST TEE (H x H x FPT) WITH PLUG				
	4132	71315	1-1/2"	10
	4133	71320	2"	10
	4134	71330	3"	10
	4135	71340	4"	5

	ID	MODEL#	SIZE	CTN
	ORDER#	MODEL#	SIZE	QTY
FITTING CLEANOUT WITH #718 THREAD PLUG (SPIGOT x FPT)				
	4136	71615	1-1/2"	50
	4137	71620	2"	50
	4138	71630	3"	25
	4139	71640	4"	10
	54668	71660	6"	10

	ID	MODEL#	SIZE	CTN
	ORDER#	MODEL#	SIZE	QTY
CAST IRON PIPE TO SPIGOT ADAPTER				
	4141 *	71740	4"	10

	ID	MODEL#	SIZE	CTN
	ORDER#	MODEL#	SIZE	QTY
THREADED PLUG (MPT)				
	4143	71815	1-1/2"	100
	4144	71820	2"	50
	4145	71830	3"	25
	4146	71840	4"	30

	ID	MODEL#	SIZE	CTN
	ORDER#	MODEL#	SIZE	QTY
TOE-SAVER FLOOR PLUG				
	578414	71852 (=P49-002)	2"	1
	4147	71853 (=P49-003)	3"	1
	53105	71854 (=P49-004)	4"	25

* = SPECIAL ORDER ITEM

	ID	MODEL#	SIZE	CTN
	ORDER#	MODEL#	SIZE	QTY
NO HUB ADAPTER (HUB x SPIGOT)				
	4150	72120	2"	25
	4151	72130	3"	20
	4152	72140	4"	15

	ID	MODEL#	SIZE	CTN
	ORDER#	MODEL#	SIZE	QTY
TRAP ADAPTER--FEMALE (HUB x SLIP JAM NUT)				
	4153	72211	1-1/2" x 1-1/4"	50

	ID	MODEL#	SIZE	CTN
	ORDER#	MODEL#	SIZE	QTY
FITTING TRAP ADAPTER--MALE (SPIGOT x SLIP JAM NUT)				
	4155	72311	1-1/2" x 1-1/4"	50

	ID	MODEL#	SIZE	CTN
	ORDER#	MODEL#	SIZE	QTY
45° STREET ELBOW (HUB x SPIGOT)				
	4159	72715	1-1/2"	100
	4160	72720	2"	50
	4161	72730	3"	20
	4162	72740	4"	10
	4163	72760	6"	3

	ID	MODEL#	SIZE	CTN
	ORDER#	MODEL#	SIZE	QTY
CLOSET BEND				
	4164	72834	4" x 3"	10

	ID	MODEL#	SIZE	CTN
	ORDER#	MODEL#	SIZE	QTY
90° SANITARY ELBOW (HUB x HUB)				
	4165	72815	1-1/2"	100
	4166	72820	2"	50
	156281	72821	2" x 1-1/2"	10
	4167	72830	3"	25
	4168	72840	4"	10
	4169	72860	6"	5

	ID	MODEL#	SIZE	CTN
	ORDER#	MODEL#	SIZE	QTY
90° SANITARY STREET ELBOW (HUB x SPIGOT)				
	4170	72916	1-1/2"	100
	4172	72926	2"	50
	4173	72936	3"	20
	4174	72946	4"	10

FPT = Female Pipe Thread
MPT = Male Pipe Thread
IPS = Iron Pipe Size
SPIGOT = Pipe O.D. Size

ID	ORDER#	MODEL#	SIZE	CTN QTY
DOUBLE WYES (ALL HUB)				
4181	73420		2"	20
4182	73421		2" x 2" x 1-1/2" x 1-1/2"	10
4183	73430		3"	15
4184	73431		3" x 3" x 1-1/2" x 1-1/2"	10
4185	73432		3" x 3" x 2" x 2"	15
4186	73440		4"	5
4187	73442		4" x 4" x 2" x 2"	5
4188	73443		4" x 4" x 3" x 3"	5

ID	ORDER#	MODEL#	SIZE	CTN QTY
DOUBLE SANITARY TEES (ALL HUB)				
	4190	73520	2"	20
	4191	73521	2" x 2" x 1-1/2" x 1-1/2"	25
	4193	73531	3" x 3" x 1-1/2" x 1-1/2"	20
	4194	73532	3" x 3" x 2" x 2"	10
	4195	73540	4"	6

ID	ORDER#	MODEL#	SIZE	CTN QTY
90° LONG SWEEP ELBOW (HUB x HUB)				
	4196	73815	1-1/2"	50
	4197	73820	2"	25
	4198	73830	3"	10
	4199	73840	4"	5

ID	ORDER#	MODEL#	SIZE	CTN QTY
CLOSET FLANGE WITH POP-TOP (HUB END) (one piece with slots and knockout test cap)				
	4201 *	75134	4" x 3" (use ID #2682 883-PT)	25
	4202 *	75140	4"	25

ID	ORDER#	MODEL#	SIZE	CTN QTY
CLOSET FLANGE WITH ADJUSTABLE METAL RING				
	4203	75150	4" x 3"	25

ID	ORDER#	MODEL#	SIZE	CTN QTY
STREET CLOSET FLANGE WITH POP-TOP				
	4204	75139	4" x 3"	25

ID	ORDER#	MODEL#	SIZE	CTN QTY
U-BEND (HUB x HUB)				
	4213	78020	2"	35

ID	ORDER#	MODEL#	SIZE	CTN QTY
----	--------	--------	------	---------

ADJUSTABLE P-TRAP WITH UNION & CLEANOUT

	4216	78215	1-1/2"	10
---	------	-------	--------	----

ADJUSTABLE P-TRAP WITH UNION LESS CLEANOUT

	4217	78315	1-1/2"	25
	4218	78320	2"	40

P-TRAP WITH CLEANOUT

	4219	78415	1-1/2"	10
---	------	-------	--------	----

P-TRAP, LESS CLEANOUT (Fits flush into fitting hub)

	4221	78515	1-1/2"	25
	4222	78520	2"	20
	4223	78530	3"	10

* = SPECIAL ORDER ITEM

FPT = Female Pipe Thread
MPT = Male Pipe Thread
IPS = Iron Pipe Size
SPIGOT = Pipe O.D. Size

ID ORDER#	TIGRE MODEL#	RBP MODEL#	GENOVA MODEL#	SIZE	CTN QTY
-----------	--------------	------------	---------------	------	---------

LONG TURN 90° ELBOW



10665	36-6553	P256	42840	4"	16
10661	36-678	P257	42860	6"	8

45° ELBOW



13764	36-6556	P504	40640	4"	30
10662	36-6562	P506	40660	6"	12

STRAIGHT TEE



13765	--	P104	41440	4"	10
10663 *	--	P106	41640	6"	5

CAP

13762	36-6568	P1604	40154	4"	24
13763	36-6565	P1606	40156	6"	24

HUB x HUB COUPLING



10664	36-6586	P661	41540	6" x 4"	24
-------	---------	------	-------	---------	----

REDUCING TEE



26001	--	P116	41464	6" x 4"	6
-------	----	------	-------	---------	---

SADDLE TEE



26002 *	--	P2106-4	--	6" x 4"	6
---------	----	---------	----	---------	---

ADAPTER COUPLING (S & D HUB x DWV HUB)













20880	117-3308	P657	71544	4" x 4"	20
-------	----------	------	-------	---------	----

* = SPECIAL ORDER ITEM

PVC PRESSURE FITTINGS

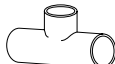
SCHEDULE 40

	ID ORDER#	MODEL#	SIZE	DESCRIPTION	CTN QTY
	125206	30307 (435-007)	3/4"	ADAPTER—FEMALE , slip x FIP	100
	125211	30407 (436-007)	3/4"	ADAPTER—MALE , slip x MIP	150
	160033	30217 (471-131)	1" x 3/4"	BUSHING , spigot x slip	250
	125218	30157 (447-007)	3/4"	CAP , slip	50
	125217	30107 (429-007)	3/4"	COUPLING , slip x slip	100
	584989	30120 (429-020)	2"	Same as above	25
	584987	30130 (429-030)	3"	Same as above	10
	125213	30607 (417-007)	3/4"	ELBOW—45° , slip x slip	100
	125214	30707 (406-007)	3/4"	ELBOW—90° , slip x slip	50
	125215	32907 (409-007)	3/4"	ELBOW—45° STREET , slip x spigot	150
	565609	31807 (450-007)	3/4"	PLUG , MPT	500
	173535	31827 (449-007)	3/4"	PLUG , spigot	250
	125216	31407 (401-007)	3/4"	TEE , slip x slip x slip	50

	ID ORDER#	MODEL#	SIZE	DESCRIPTION	CTN QTY
	125200	38507 (489-007)	3/4"	CONDENSATE P-TRAP , 1-piece	50
	125201	38007 (488-007)	3/4"	CONDENSATE RUNNING TRAP , 1-piece	50
	227748	34227 (438-248)	2" x 3/4"	FLUSH REDUCER BUSHING , Schedule 40 PVC	50

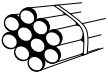
	ID ORDER#	MODEL#	SIZE	CTN QTY
	47056	50005 (HPB47001210)	1/2" x 10'	500'
	47057	50007 (HPB47003410)	3/4" x 10'	250'
	659615	560010 (HPB4700110)	1" x 10'	150'

90° ELBOW (HC30)				
	47059	50705	1/2"	20
	47060	50707	3/4"	20
	659617	50710	1"	10

90° STREET ELBOW (HC30A)				
	47357	52905	1/2"	10
	47356	52907	3/4"	10
	664227	92167	1"	10

45° ELBOW (HC36)				
	47062	50605	1/2"	20
	47063	50607	3/4"	20
	659618	50610	1"	10

45° STREET ELBOW (HC36A)				
	47064	52705	1/2"	20
	47065	52707	3/4"	20

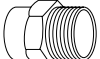
MALE ADAPTER (HC5) <i>(For cold water application only —not ASTM D 2846 approved.)</i>				
	47067	50405	1/2"	20
	47068	50407	3/4"	10

FEMALE ADAPTER (HC-10) <i>(For cold water application only —not ASTM D 2846 approved.)</i>				
	47369	50305	1/2"	20
	47355	50307	3/4"	10

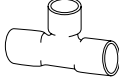
TEE (HC50)				
	47070	51405	1/2"	20
	47071	51407	3/4"	20
	659620	51410	1"	10

REDUCING TEE (HC50)				
	58372	51471	3/4" x 3/4" x 1/2"	20
	58373	51473	3/4" x 1/2" x 1/2"	20
	58375	51476	3/4" x 1/2" x 3/4"	20

COUPLING (HC20)				
	47073	50105	1/2"	20
	47074	50107	3/4"	20
	659621	50110	1"	10

REDUCING COUPLING (HC20)				
	58376	50175	3/4" x 1/2"	10

CAP (HC70)				
	58378	50155	1/2"	10
	58377	50157	3/4"	10





BUSHING (HC90)				
	58379	50275	3/4" x 1/2"	10
	619289	50217	1" x 3/4"	10



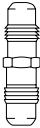

IMPORTANT NOTES:

- (1) CPVC is not recommended for use with compressed air or gases.
- (2) Occasionally, CPVC materials can be damaged by contact with chemicals found in some construction products. CALL OUR OFFICE FOR MORE INFORMATION.

BRASSCRAFT FLARE & COMPRESSION FITTINGS



ID ORDER#	MODEL#	SIZE	CTN QTY	
PLUG — OD FLARE				
	4299	39-4	1/4"	10
	4300	39-6	3/8"	10
	4302	39-8	1/2"	10
CAP — OD FLARE				
	4303	40-6	3/8"	10
	4304	40-8	1/2"	10
NUT, SHORT — OD FLARE				
	4308	41S-4	1/4"	10
	4309	41S-6	3/8"	10
	4310	41S-8	1/2"	10
	4311	41S-10	5/8"	5
	574562	41S-12	3/4"	10
	4312	41S-14	7/8"	10
UNION — OD FLARE				
	4315	42-4	1/4"	10
	4316	42-6	3/8"	10
	4317	42-8	1/2"	10
	34368	42-10	5/8"	5
UNION — OD FLARE x FIP				
	4318	46-6-6	3/8" x 3/8"	10
	4320	46-6-8	3/8" x 1/2"	10
	4322	46-8-8	1/2" x 1/2"	10
	4325	46-10-8	5/8" x 1/2"	10
UNION — OD FLARE x MIP				
	4330	48-4-2	1/4" x 1/8"	10
	4329	48-4-4	1/4" x 1/4"	10
	4331	48-4-6	1/4" x 3/8"	10
	4332	48-4-8	1/4" x 1/2"	10
	4334	48-6-4	3/8" x 1/4"	10
	4333	48-6-6	3/8" x 3/8"	10
	4335	48-6-8	3/8" x 1/2"	10
	4336	48-6-12	3/8" x 3/4"	10

ID ORDER#	MODEL#	SIZE	CTN QTY	
UNION — OD FLARE x MIP (continued)				
	4339	48-8-6	1/2" x 3/8"	10
	4337	48-8-8	1/2" x 1/2"	10
	4340	48-8-12	1/2" x 3/4"	10
	4341	48-10-8	5/8" x 1/2"	5
	4342	48-10-12	5/8" x 3/4"	10
NUT, Forged Refrigeration — OD FLARE				
STRAIGHT				
	227926	141S-4	1/4" x 1/4"	10
	43786	141S-6	3/8" x 3/8"	10
	4392	141S-8	1/2" x 1/2"	10
	34369	141S-10	5/8" x 5/8"	10
	227927	141S-12	3/4" x 3/4"	10
REDUCING				
	4393	141S-8-6	1/2" x 3/8"	10
TEE (Tube All Three Ends) — OD FLARE				
	4397	144-6	3/8"	10
	4398	144-8	1/2"	10
	4399	144-10	5/8"	10
TEE — OD FLARE x MIP				
	4400	145-6-6	3/8" x 3/8"	10
ELBOW — OD FLARE x MIP				
	4408	149-4-2	1/4" x 1/8"	10
	4407	149-4-4	1/4" x 1/4"	10
	4414	49-6-4	3/8" x 1/4"	10
	4411	149-6-6	3/8" x 3/8"	10
	4416	149-8-8	1/2" x 1/2"	10

FOR ADDITIONAL INFORMATION, VISIT THE
BRASSCRAFT WEBSITE AT www.brasscraft.com

BRASSCRAFT FLARE & COMPRESSION FITTINGS



ID	ORDER#	MODEL#	SIZE	CTN QTY
----	--------	--------	------	---------

ELBOW — OD FLARE x FIP

4421	150-6-6	3/8" x 3/8"	10
------	---------	-------------	----

SLEEVE (Ferrule) — OD COMP



4346	60-4	1/4"	10
4347	60-6	3/8"	10
4348	60-8	1/2"	10
4349	60-10	5/8"	5

PLASTIC SLEEVE (Ferrule) — OD COMP

685552	60PT-4	1/4"	10
49626	60PT-6	3/8"	10

NUT — OD COMP



4352	61-4	1/4"	10
4353	61-6	3/8"	10
4354	61-8	1/2"	10
4355	61-10	5/8"	5

UNION — OD COMP (lead free)

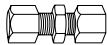

669270	62-4X	1/4"	10
669271	62-6X	3/8"	10
669272	62-8X	1/2"	10
669291	62-10X	5/8"	10
669294	62-14X	7/8"	10

TEE — OD COMP (lead free)

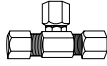

669274	64-4X	1/4"	10
669275	64-6X	3/8"	10
669276	64-8X	1/2"	10
669273	64-10X	5/8"	10

ID	ORDER#	MODEL#	SIZE	CTN QTY
----	--------	--------	------	---------

UNION — OD COMP x FIP



669277	66-4-2X	1/4" x 1/8"	10
--------	---------	-------------	----

UNION — OD COMP x MIP



669281	68-4-2X	1/4" x 1/8"	10
669283	68-4-4X	1/4" x 1/4"	10
669284	68-6-2X	3/8" x 1/8"	10
669285	68-6-4X	3/8" x 1/4"	10
669286	68-6-6X	3/8" x 3/8"	10
669287	68-6-8X	3/8" x 1/2"	10
669295	68-8-6X	1/2" x 3/8"	10
669296	68-8-8X	1/2" x 1/2"	10
669278	68-14-12X	7/8" x 3/4"	10

ELBOW — OD COMP x MIP (lead free)



669300	69-2-2X	1/8" x 1/8"	10
669301	69-4-2X	1/4" x 1/8"	10
669302	69-4-4X	1/4" x 1/4"	10
669304	69-6-4X	3/8" x 1/4"	10
669305	69-6-6X	3/8" x 3/8"	10
669306	69-6-8X	3/8" x 1/2"	10

ELBOW — OD COMP x GH (garden hose — for dishwasher)

693320	HES-6-12X1	3/8" x 3/4"	50
--------	------------	-------------	----

**FOR ADDITIONAL INFORMATION, VISIT THE
BRASSCRAFT WEBSITE AT www.brasscraft.com**

**FOR FERRULE, USE ID #10249
(HONEYWELL #386449-1)**

BRASSCRAFT



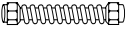

APPLIANCE CONNECTORS & UNIONS

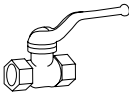

	ID ORDER#	MODEL#	SIZE	CONNECTION	DESCRIPTION	CTN QTY
	235860	CSSC54-18	18"	1/2"FIP x 1/2"MIP	GAS APPLIANCE CONNECTOR , coated stainless steel, corrugated, AGA approved (=#EFGC-012-YE-1011-18)	25
	767973	CSSC54-24	24"	1/2"FIP x 1/2"MIP	<i>Same as above</i> (=#EFGC-012-YE-1011-24)	25
	235861	CSSC54-36	36"	1/2"FIP x 1/2"MIP	<i>Same as above</i> (=#EFGC-012-YE-1011-36)	25
	214921	CSSC54-48	48"	1/2"FIP x 1/2"MIP	<i>Same as above</i> (=#EFGC-012-YE-1011-48)	25
	42199	MAU1-10-8S	5/8" OD x 1/2"	Flare x FIP	STEEL UNION , flare x female, flare end is 15/16", 16 thread, for stainless steel connector	25
	42201	MAU2-10-8S	5/8" OD x 1/2"	Flare x MIP	<i>Same as above</i> , but flare x male	25
	42202	MAU2-10-12S	5/8" OD x 3/4"	Flare x MIP	<i>Same as above</i>	25

FOR ADDITIONAL INFORMATION, VISIT THE BRASSCRAFT WEBSITE AT www.brasscraft.com



	ID ORDER#	MODEL#	TYPE	SIZE	DESCRIPTION	CTN QTY
BALL VALVES						
	* = SPECIAL ORDER ITEM					
	672014	G100	NPT	1/2"	BALL VALVE , lead free DZR brass body, 2-piece, female NPT x female NPT, blow-out proof stem, full port, adjustable packing, 600 WOG,	24
	672015	G100	NPT	3/4"	Same as above	24
	672016	G100	NPT	1"	Same as above	8
	672017	G100	NPT	1-1/4"	Same as above	4
	672018	G100	NPT	1-1/2"	Same as above	4
	672019	G100	NPT	2"	Same as above	2
	672008	G100S	CxC	1/2"	Same as above, but <u>solder x solder</u>	30
	672009	G100S	CxC	3/4"	Same as above	24
	672001	G100S	CxC	1"	Same as above	5
	672010	G100S	CxC	1-1/4"	Same as above	12
	672011	G100S	CxC	1-1/2"	Same as above	8
	672012	G100S	CxC	2"	Same as above	4
	740600	G200SW	CxC	1/2"	Same as above, but <u>solder x solder and with waste</u>	30
GLOBE VALVES, COMPRESSION						
	674774	G60S	CxC	1/2"	STOP AND WASTE VALVE , lead free brass, female NPT x female NPT, 125 CWP	30
	674775	G60S	CxC	3/4"	Same as above	15
CHECK VALVES						
	672154 *	G31	NPT	1/2"	CHECK VALVE , lead free brass, female NPT x female NPT, 200 WOG	6
	672155	G31	NPT	3/4"	Same as above	6
	672156 *	G31	NPT	1"	Same as above	3
	672157	G31	NPT	1-1/4"	Same as above	2
	672159	G31	NPT	1-1/2"	Same as above	2
	672160	G31	NPT	2"	Same as above	2
SILLCOCKS						
	845 *	M74S	CxH	1/2"	SILLCOCK , brass, solder x garden hose thread, 125 CWP	12
	847	M74S	CxH	3/4"	Same as above	10

* = SPECIAL ORDER ITEM

FOR ADDITIONAL INFORMATION, VISIT THE AMERICAN VALVE WEBSITE AT www.americanvalve.com

PRIER

ANTI-SIPHON WALL HYDRANTS & PARTS



ID ORDER#	MODEL#	DESCRIPTION
ANTI-SIPHON WALL HYDRANTS		
	544503 478-06B	ANTI-SIPHON FREEZELESS WALL HYDRANT , 6" insertion, integral cast flange with built-in drainage pitch, wide screw holes and stainless steel mounting screws, solid brass body and seat, satin nickel plated body, easy grip polycarbonate beige colored handle, EPDM backflow preventer
	544504 478-08B	Same as above, but 8" insertion
	544505 478-10B	Same as above, but 10" insertion
	544509 478-12B	Same as above, but 12" insertion
	544510 478-14B	Same as above, but 14" insertion
PARTS		
	229300 630-7965	HANDLE , black, #300, #400 and #500 series sillcocks, includes handle and screw
	633423 630-7975	Same as above, but beige
	174895 630-7755	SERVICE PAK , for #478 and #578 series sillcocks, consists of (2) bonnets and (1 each) o-ring, bonnet o-ring, stem packing, backflow washer, packing washer, bibb retainer, seat washer and screw Note: This kit replaces #630-7754 and #630-7964 kits and will repair #478, #479, #482, #578, #579, #582, #378, #379, and #382.
	39344 630-7500	VACUUM BREAKER KIT , for #478 and #578 series sillcocks, consists of (1 each): #225-9006 cap, #174-9007 bonnet, #747-9019 seat washer and #123-0091 plunger

FOR ADDITIONAL INFORMATION, VISIT THE PRIER WEBSITE AT www.prier.com

WOODFORD

WALL FAUCETS & HYDRANTS

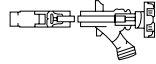

ID ORDER#	MODEL#	DESCRIPTION	CTN QTY
 544578	17CP-8-MH	ANTI-SIPHON FREEZELESS WALL FAUCET , permanent stainless steel seat, adjustable flange & packing nut, for 8" wall thickness; for 1/2" FIP and 1/2" female sweat, metal handle; State of Michigan approved	10
544582	17CP-10-MH	<i>Same as above</i> , but for 10" wall thickness	10
544583	17CP-12-MH	<i>Same as above</i> , but for 12" wall thickness	10
544586	17CP-14-MH	<i>Same as above</i> , but for 14" wall thickness	10
773653	17PX-6-MH	<i>Same as above</i> , but with 1/2" PEX tube fitting and 6" wall thickness	10
706928	17PX-8-MH	<i>Same as above</i> , but for 8" wall thickness	10
773654	17PX-10-MH	<i>Same as above</i> , but for 10" wall thickness	10
678196	17PX-12-MH	<i>Same as above</i> , but for 12" wall thickness	10
160830	22CP	ANTI-SIPHON HOT & COLD FREEZELESS WALL FAUCET , with metal handle, 5" CC, "push-to-turn" hot water handle, combination 1/2" FIP x 1/2" female sweat, 120°F maximum water temperature, permanent stainless steel seat, adjustable packing, for 8" wall thickness. State of Michigan approved. Warning: faucet must be installed with downward pitch toward nozzle and hose must be removed in freezing weather or faucet may freeze and burst	10
157492	22CP	<i>Same as above</i> , but for 12" wall thickness	10
1045	25C	FREEZELESS WALL FAUCET , 12", features automatic draining, long life plunger; sized for ID sweating of 1/2" K, L or M or OD sweating with 3/4" M copper	10
34020	65C	FREEZELESS WALL HYDRANT , features vacuum breaker and backflow protection; State of Michigan approved	5

FOR ADDITIONAL INFORMATION, VISIT THE WOODFORD WEBSITE AT www.woodfordmfg.com

WOODFORD REPAIR PARTS





ID ORDER#	MODEL#	DESCRIPTION
1083	51013	BALL VALVE—RUBBER , used on #70 and #72
1081	50028	BRASS NUT—ROUND , used on #32 and #70
565588	55176	BRASS HEAD NUT ASSEMBLY , for all wall hydrants, (Y70 and Y95) consisting of (1) #30107 brass packing nut and (1) #30247 packing
1068	30002	HANDLE SCREW , used on #14C, #17, 24/26 Series, and Y30
1086	51030	HEAD NUT COVER , for all wall hydrants
27299	30560	PACKING—EPDM , used on #14C, #17C, #24, Y24, B24 (= #30005)
1077	50024	PACKING , for all wall hydrants, used on #Y70 & Y95
565591	30247	PACKING , for all 24/26 Series, B24, all wall hydrants, Y70 and Y95
1085	55111	PACKING NUT ASSEMBLY—CHROME , for all wall hydrants
565589	30107	PACKING NUT , brass, for all wall hydrants
1079	50027	PLAIN SUPPORT WASHER , used on #32 and #70
18065	30230	PLUNGER ASSEMBLY , for #20, #25C and #27
141442	RK-14MH	REPAIR KIT , for #14 Series
141441	RK-17MH	Same as above, but for #17 Series
74729	RK-25	Same as above, but for #25C, with plunger (= old #35300)
1069	30009	RETAINER SCREW , for rubber, used on #14C
1073	RK-STK	TEE KEY , used on #25C (= old #50009)
27300	30006	WASHER—BRASS , used on #14C
442424	30096	WHEEL HANDLE—METAL , used on #14C & #17C
36349	30239	WHEEL HANDLE—METAL , used on #20, #25C, #27

FOR ADDITIONAL INFORMATION, VISIT THE WOODFORD WEBSITE AT www.woodfordmfg.com

ZURN

DRAINS, STRAINERS & LIGHT COMMERCIAL



	ID ORDER#	MODEL#	SIZE	DESCRIPTION
DRAINAGE				
	248482	P415-2NH-P-SA-CPT (Z415-2NH)	2"	NO-HUB FLOOR DRAIN BODY WITH TRAP PRIMER , dura-coated cast iron body only with bottom outlet, combination invertible membrane clamp and adjustable collar
	198216	P415-3NH-P-SA-CPT (Z415-3NH)	3"	Same as above
	248481	P415-4NH-P-SA-CPT (Z415-4NH)	4"	Same as above
	50527	P415-4NH-P-SA-C (Z415-4NH)	4"	NO-HUB FLOOR DRAIN BODY LESS TRAP PRIMER , dura-coated cast iron body only with bottom outlet, combination invertible membrane clamp and adjustable collar
	50538	ZB-400-B5	5"	STRAINER BODY AND GRID , polished brass, round adjustable light duty strainer top with squared heel-proof openings and secured grate
	50537	ZN-400-B5	5"	Same as above, but nickel brass
	50540	ZB-400-B6	6"	Same as above, but 6" polished brass
	50539	ZN-400-B6	6"	Same as above, but nickel brass
LIGHT COMMERCIAL				
	146331	FD2210-PV3	3"	FLOOR DRAIN—ROUND ADJUSTABLE NICKEL , 5-3/16", assembled with 3" PVC body, solvent weld connection type, with nickel bronze head and heel-proof grate

FOR ADDITIONAL INFORMATION, VISIT THE ZURN WEBSITE AT www.zurn.com

ID ORDER#	MODEL#	SIZE	DESCRIPTION
34320	970-214S (Jones A05-014)	14" x 14"	ACCESS PANEL , ABS plastic, snap-in
2679	B04-400	4"	BACKWATER VALVE—PLUMBCO PVC LESS CAP AND SLEEVE , with bolted plastic access cover, featuring flexible vinyl flapper; for use with 4" Schedule 40 pipe
743665	834-4PNR	4"	CLEANOUT ASSEMBLY—FINISHLINE ADJUSTABLE , 4" PVC hub, fits base with 3-1/2" plastic spud and 6-1/2" round nickel bronze strainer
53946	889-45PM	3"	CLOSET FLANGE SPACER KIT—ADJUSTABLE , 3" flush-to-floor
248203	884-PTM	3"	CLOSET FLANGE—FLUSH TO FLOOR , 3" hub/inside 4", 2-1/2" long tailpiece
741916	886-4PM	4"	CLOSET FLANGE—HUB , with stainless steel swivel ring
741917	886-GP	4"	CLOSET FLANGE—"PUSH-TITE" , inside fit gasket with plastic ring, 4"-long tailpiece
2682	883-PT (Jones C50-340)	3" or 4"	CLOSET FLANGE—PVC "FLUSH FIT" , with knockout test plug; fits over 3" or inside 4" Schedule 40 pipe (Genova #75134)
74090	43501	2", 3" or 4"	CLOSET FLANGE—PVC OFFSET , allows 4-way offset of 2"; fits over 3" or inside 4" Schedule 40 pipe
52330	886-411 (Jones C88-600)	--	CLOSET FLANGE SPACER KIT—PVC
752380	886-MR	7"	CLOSET REPAIR RING , stainless steel
74898	4030 (Jones C27-134)	1" x 3/4"	CLOSET SPUD , cast brass
63338	4028 (Jones C27-150)	1-1/2"	Same as above
6988	902 (Jones D10-001)	3/4"	DISHWASHER CONNECTOR , with two clamps
670094	696-C3 (Jones G20-155)	3/4"	DRAIN CAP , leadfree brass with washers, 2/pkg
45814	847-2PK1	3"	DRAIN COVER—FLOOR, STAINLESS STEEL , friction fit, sized to the pipe ID, for 2" nominal pipe
45815	847-3PK1	4"	Same as above, but for 3" nominal pipe
45817	847-4 (Jones D59-003)	5"	Same as above, but for 4" nominal pipe

ID ORDER#	MODEL#	SIZE	DESCRIPTION
2688	D54-003	3"	DRAIN FITTING—SNAP-IN , slides inside pipe cut flush with finished floor level, stainless steel strainers
761182	832-25PNR	2" or 3"	DRAIN—FLOOR, FINISHLINE PVC , with round 5-1/2" nickel bronze top, fits over 2" pipe or inside 3"
691724	832-36PNR	3" or 4"	<i>Same as above</i> , but fits over 3" pipe and inside 4" and 6-1/2" top (=Jones-Stephens D41-141)
63500	D54-100	3" or 4"	DRAIN—FLOOR, PVC , with stainless steel strainer, fits over 3" pipe and inside 4" pipe
748495	840-20PNR	2" or 3"	DRAIN—FLOOR , PVC round, general purpose, light duty PVC with nickel bronze ring and strainer that fits over 2" or inside 3" Schedule 40 pipe
20984	D50-102	2"	DRAIN—FLOOR OR SHOWER, PVC , pan type, 4" polished brass strainer and tailpiece (=Plastic Oddities #PBR-410)
16616	821-2PCP (Jones D50-111)	2"	DRAIN—FLOOR OR SHOWER, PVC , "low-profile" unit, includes a 4-1/4" stainless steel strainer; chrome-plated tailpiece fits over 2" or inside 3" Schedule 40 pipe
14550	867-P4M (Jones R18-006)	4"	DRAIN—ROOF , with plastic body and gravel guard, cast iron dome; fits 4" Schedule 40 pipe
1602	42099	2"	DRAIN—SHOWER , with 4-1/2" chrome grid, self-caulk with neoprene gasket
67417	42150	2"	DRAIN—SHOWER , brass, with 4-1/4" stainless steel strainer
2683	825-2P (Jones D41-001)	2"	DRAIN—SHOWER, PVC , includes 4-1/4" stainless steel strainer; for fiberglass or acrylic shower stalls; used with Schedule 40 solvent weld joint; for 2" compression drain
565600	825-2PFS	2"	Same as above, but offset (provides 3/4" offset in any direction)
144735	926-2	1/2"	ESCUTCHEON (PLATE) , plastic hinged, polished chrome (=Jones #F06-375)
144737	926-2W	1/2"	Same as above, but white (=Jones #F07-375)
144736	926-3	3/4"	Same as above (=Jones #F06-050)
743783	601Q30V	3/4" x 1/4"	PDQ ADD-A-LINE , 3/4" PDQ x 1/4" compression, no lead copper
27197	390-50153 (Jones P70-023)	--	PIPE CUTTER , with 2" shaft, cuts inside and outside, for PVC
740725	861-5	--	SAFE-WASTE GRATE—FULL TOP , PVC, for 861-3PX
740729	861-3PX	3"	SAFE-WASTE SLOP SINK , PVC with 3" outlet, less grate
740726	863-U	--	SAFE-WASTE STRAINER—ALUMINUM , flat, for 861-3PX

ID ORDER#	MODEL#	SIZE	DESCRIPTION
122871	490-11320 (Jones C87-100)	--	SAVE-A-FLANGE CLOSET FLANGE REPAIR KIT , includes repair bar, screws, anchors and spacer washer
56816	S01-050	1/2"	SHOWER STALL ELBOW—FIBERGLASS , with locknuts, combination 1/2" female sweat or NPS inlet, 1/2" NPT outlet; for securing shower arm elbow to fiberglass shower stall or for securing tub spout nipple; for use with copper, iron pipe or compression fittings
119955	C27-301	1-1/4"	SPUD GASKET
119958	C27-302	1-1/2"	<i>Same as above</i> (=Sioux Chief 490-11522)
119959	C27-303	2"	<i>Same as above</i>
586178	42017	4-1/4"	STRAINER , round, stainless steel, oil rubbed bronze finish, fits Oatey #42099 and #42150 shower drains
600584	42018	4-1/4"	Same as above, but brushed nickel finish
775574	42422	4-1/4"	Same as above, but matte black finish
89087	33478 (Jones T33-152)	1-1/2" x 2"	TEST CAP—PVC DUAL FIT , 1-1/2" x 2"
89088	33480 (Jones T33-304)	3" x 4"	<i>Same as above</i> , but 3" x 4"
5249	882-2 (Jones T31-002)	2"	TEST PLUG
5250	882-3 (Jones T31-003)	3"	<i>Same as above</i> , but 3"
5251	882-4 (Jones T31-004)	4"	<i>Same as above</i> , but 4"
14551	867-C (Jones R18-011)	--	UNDERDECK CLAMP , for 867-P4M PVC roof drain
96672	868-5P (Jones F10-002)	2"	URINAL FLANGE KIT—PVC , radially adjustable, 2"
38353	39012	1-1/2"	VENT VALVE , ideal for wet bar or vanity venting; conventional stack not required. Not approved for toilets

FERNCO

PLUMBING SPECIALTIES



ID ORDER#	MODEL#	SIZE	DESCRIPTION	CTN QTY
2412	1002-44	4" x 4"	CLAY TO CAST IRON OR SCHEDULE 40 PLASTIC	30
24133	1002-64	6" x 4"	<i>Same as above</i>	10
32292	1002-66	6" x 6"	<i>Same as above</i>	10
60339	1056-150/125	1-1/2" x 1-1/4"	SCHEDULE 40, PVC TO PVC, CAST IRON TO CAST IRON, PVC TO CAST IRON	40
2417	1056-150	1-1/2" x 1-1/2"	<i>Same as above</i>	40
2419	1056-215	2" x 1-1/2"	<i>Same as above</i>	40
2413	1056-22	2" x 2"	<i>Same as above</i>	40
135891	1056-32	3" x 2"	<i>Same as above</i>	20
2414	1056-33	3" x 3"	<i>Same as above</i>	40
25190	1056-43	4" x 3"	<i>Same as above</i>	40
2415	1056-44	4" x 4"	<i>Same as above</i>	40
2416	1056-64	6" x 4"	<i>Same as above</i>	10
19171	1056-66	6" x 6"	<i>Same as above</i>	10
136133	QC-101	1-1/2"	QWIK CAP TEST CAP, SCHEDULE 40 PVC WITH STAINLESS STEEL BAND	40
136134	QC-102	2"	<i>Same as above</i>	40
136132	QC-103	3"	<i>Same as above</i>	40
36005	QC-104	4"	<i>Same as above</i>	20
664482	FTS-3	3"	WAX FREE TOILET SEAL , flexible PVC for 3" drain pipe	20
664485	FTS-4	4"	Same as above, but for 4" drain pipe	20
664486	FTS-4CF	3" x 4"	Same as above, but for 3" x 4" combination flange	20
664487	FUS-2	2"	WAX FREE URINAL SEAL , flexible PVC for 2" drain pipe	24

FOR ADDITIONAL INFORMATION, VISIT THE FERNCO WEBSITE AT www.fernco.com

- Fast and easy to install
- No special tools required
- Low maintenance
- No flow restriction
- 100% effective and safe
- ASSE 1072 approved

WARRANTY

- 10-year limited warranty

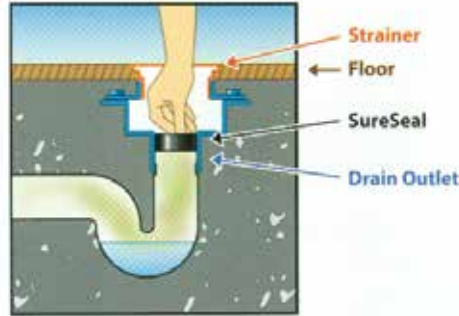

ID ORDER#	SURESEAL MODEL#	ID ORDER#	SIOUX CHIEF MODEL#	DESCRIPTION
FLOOR DRAIN TRAP SEAL				
657820	SS2009 (97041)	762878	835-2	FLOOR DRAIN TRAP SEAL , for 2" floor drain
657805	SS3009V (97042)	772022	835-3	Same as above, but 3" drain
657821	SS4009V (97044)	772023	835-4	Same as above, but for 4" floor drain or any size floor drain with a 4" strainer

FOR ADDITIONAL INFORMATION, VISIT THE RECTORSEAL WEBSITE AT www.rectorseal.com

ADMITTANCE VALVES, ARRESTERS and TRAP PRIMER SYSTEM



ID	MODEL#	DESCRIPTION	* = SPECIAL ORDER ITEM
ORDER#			
	743757 250-122PB	AIR ADMITTANCE VALVE—TURBOVENT , with adapter	
	152006 652-AS	HYDRARESTER—MALE SWEAT/PRESS COMPATIBLE , 1-3/8" chamber width, 8-3/4" male sweat, 5" cubic inch volume, 350 PSI maximum working pressure, 250°F maximum working temperature, 1/2" connection size, 1-11 fixture unit capacity (P.D.I. size A), ASSE-1010-2004 certified	
	140905 652-A	HYDRARESTER—MIP , 1-3/8" chamber width, 6-1/2" male sweat, 5" cubic inch volume, 350 PSI maximum working pressure, 250°F maximum working temperature, 1/2" connection size, lead-free, 1-11 fixture unit capacity (P.D.I. size A), ASSE-1010-2004 certified	
	140337 653-B	<i>Same as above</i> , but 8-3/4" male sweat, 7" cubic inch volume, 3/4" connection size, and 12-32 fixture unit capacity (P.D.I. size B)	
	771355 660-GTR0B	MINIRESTER , 1/4" OD compression x 1/4" OD female compression, no-lead, ASSE-1010 and NSF-61 compliant	
	743760 660-GTR1B	<i>Same as above</i> , but 3/8" OD compression x 3/8" OD female compression	
	726928 660-GTX2	MINIRESTER , 1/2" PEX tee F1807, lead-free, copper tube	
	726931 660-GTX2B	<i>Same as above</i> , but stainless steel tube	
	154861 *	MINIRESTER—MIP STRAIGHT , 1/2", 350 PSI maximum working pressure, 250°F maximum working temperature, used for single fixture residential and light commercial use, ASSE certified and AA rated for use in most residential applications, install at any angle in rough-in installations with 1/2" FIP thread fittings, 4-3/4" length	
	154862 660-SB	<i>Same as above</i> , but <u>male sweat</u> connection, 6-1/2" length. Per manufacturer: do not overheat and do not braze! Heat female fitting only.	
	154863 660-HB	MINIRESTER—LAUNDRY ARRESTER , screws on to washing machine outlet box valves, 3/4" female swivel hose thread x 3/4" male hose thread connection	
	444019 695-01	TRAP PRIMER VALVE—PRIME PERFECT , with debris screen, 1/2" FIP inlet x 1/2" MIP outlet, 2-3/4" diameter x 5" length, activates with a 10 PSIG pressure drop at 30-150 PSIG, certified to the ASSE 1018-2001 standard	
	444093 695-D20	TRAP PRIMING DISTRIBUTOR , (2) 1/4" OD male sweat branches; check local state code for compliance	

ADDITIONAL INFORMATION, VISIT THE SIOUX CHIEF WEBSITE AT www.siouxchief.com

FLEXTHERM® (Halstead) UNSLIT INSULATION (†)

Seam-seal, flexible elastomeric, closed-cell insulation, black color, working temperatures from -70°F to +220°F



ID ORDER#	MODEL#	INSULATION	COPPER PIPE I.D.	COPPER PIPE O.D.	IRON I.D.	WALL SIZE	FEET PER CTN	PIECES PER CTN
7008	PFT05812	5/8" x 6'	1/2"	5/8"	3/8"	1/2"	300	50
45988	PFT03412	3/4" x 6'	5/8"	3/4"	1/2"	1/2"	240	40
7009	PFT07812	7/8" x 6'	3/4"	7/8"	--	1/2"	210	35
7010	PFT11812	1-1/8" x 6'	1"	1-1/8"	--	1/2"	150	25
7011	PFT13812	1-3/8" x 6'	1-1/4"	1-3/8"	--	1/2"	120	20
7012	PFT15812	1-5/8" x 6'	1-1/2"	1-5/8"	1-1/4"	1/2"	90	15
7014	PFT21812	2-1/8" x 6'	2"	2-1/8"	--	1/2"	60	10
217689 **	APT20012	2-3/8" x 6'	--	--	2"	1/2"	60	10
11740	PFT25812	2-5/8" x 6'	2-1/2"	2-5/8"	--	1/2"	60	10
7017	PFT31812	3-1/8" x 6'	3"	3-1/8"	--	1/2"	42	7
7018	PFT35812	3-5/8" x 6'	3-1/2"	3-5/8"	--	1/2"	36	6

** WHILE SUPPLIES LAST

IMCOLOCK® PRE-SLIT INSULATION (†)

Self-seal, polyolefin closed-cell foam insulation, black color, retains flexibility to -165°F, pre-glued (both sides), working temperatures from -330°F to +210°F

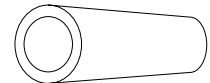
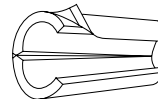

42624	6IL048038	3/8" x 6'	1/4"	3/8"	1/8"	1/2"	414	69
42625	6IL048048	1/2" x 6'	3/8"	1/2"	1/4"	1/2"	336	56
42626	6IL048058	5/8" x 6'	1/2"	5/8"	3/8"	1/2"	300	50
42627	6IL048068	3/4" x 6'	5/8"	3/4"	1/2"	1/2"	264	44
42629	6IL048078	7/8" x 6'	3/4"	7/8"	--	1/2"	240	40
42631	6IL048118	1-1/8" x 6'	1"	1-1/8"	--	1/2"	186	31
42633	6IL048138	1-3/8" x 6'	1-1/4"	1-3/8"	1"	1/2"	150	25
42634	6IL048158	1-5/8" x 6'	1-1/2"	1-5/8"	1-1/4"	1/2"	120	20
42635	6IL048200	2" x 6'	--	--	1-1/2"	1/2"	102	17
42636	6IL048218	2-1/8" x 6'	2"	2-1/8"	--	1/2"	84	14
42637	6IL048238	2-3/8" x 6'	--	--	2"	1/2"	72	12
42639	6IL048278	2-7/8" x 6'	--	--	2-1/2"	1/2"	54	9
89086	6IL048348	3-1/2" x 6'	--	--	3"	1/2"	36	6
143556	6IL048358	3-5/8" x 6'	3-1/2"	3-5/8"	--	1/2"	36	6

IMCOSHEET® FLAT SHEET INSULATION (†)

Black color, flexible, polyethylene, -160°F to +200°F operating temperature range, 1.5# - 2# per cubic foot density

453304	6ZRFG3X4048	1/2" x 3' x 6'	--	--	--	--	--	20
--------	-------------	----------------	----	----	----	----	----	----

(†) NOTE:

	DENSITY	WATER VAPOR	CONDUCTIVITY	BTU/HR PER SQ.FT. @ 75°F
FLEXTHERM® INSULATION	ASTM-C303	ASTM-E96	ASTM-C177	.265
IMCOLOCK® INSULATION	ASTM-D1622	ASTM-E96	ASTM-C177	.25
	ASTM-D3575		ASTM-C518	
IMCOSHEET® INSULATION	--	ASTM-E96	ASTM-C177	.25

KNAUF FIBERGLASS PIPE INSULATION

Knauf pipe insulation is a molded, heavy density, one-piece insulation made from glass fibers. The jacket is a white kraft paper bonded to aluminum foil, reinforced with glass fibers and is furnished with a self-sealing adhesive strip. A butt strip is also furnished for each section. This product is designed for use on either hot or cold piping and recommended for a wide range of temperatures. For specifics regarding our stock, thermal efficiencies, and other design and application information, please contact our office.

See Speedline on page 122 for our selection of PVC fittings covers which provide a smooth, seamless method of installation.



ID ORDER#	INSULATION I.D.	WALL SIZE	FITS PIPE SIZE		FEET PER CTN	PIECES (†) PER CTN
			COPPER I.D.	IRON I.D.		
14850	5/8" x 3'	1/2"	1/2"	3/8"	330	110
14851	7/8" x 3'	1/2"	3/4"	1/2"	255	85
14852	1-1/8" x 3'	1/2"	1"	3/4"	204	68
14853	1-3/8" x 3'	1/2"	1-1/4"	1"	168	56
6562	5/8" x 3'	1"	1/2"	3/8"	126	42
6564	7/8" x 3'	1"	3/4"	1/2"	126	42
6565	1-1/8" x 3'	1"	1"	3/4"	126	42
6567	1-3/8" x 3'	1"	1-1/4"	1"	135	45
6568	1-5/8" x 3'	1"	1-1/2"	1-1/4"	135	45
6570	1-7/8" x 3'	1"	--	1-1/2"	99	33
6572	2-1/8" x 3'	1"	2"	--	99	33
6573	2-3/8" x 3'	1"	--	2"	99	33
6577	2-7/8" x 3'	1"	--	2-1/2"	75	25
6579	3-1/2" x 3'	1"	--	3"	60	20
6582	4-1/2" x 3'	1"	--	4"	42	14

ACCESSORIES

86742 **#10298 FIBERGLASS 3" x 150' TAPE**, for above pipe insulation, 16/ctn

146167 **TAPE APPLICATOR**

FOR PVC FITTING COVERS, SEE PAGE 122

FOR ADDITIONAL INFORMATION, VISIT THE KNAUF WEBSITE AT www.knaufnorthamerica.com

SPEEDLINE PVC FITTING COVERS



25/50 SMOKE-SAFE PVC SHORT RADIUS FITTING COVERS

	ID ORDER#	MODEL#	MODEL#	DESCRIPTION	CTN QTY	
	14931	#3	PVFT0309IS	90° ELBOW COVER WITH INSERT , white	100	
	14932 *	#4	PVFT0409IS	Same as above	50	
	14933	#5	PVFT0509IS	Same as above	50	
	12348	#7	PVFT0609IS	Same as above	50	
	12349	#9	PVFT0909IS	Same as above	50	
	12350	#10	PVFT1009IS	Same as above	25	
	12351	#11	PVFT1109IS	Same as above	25	
	47047 *	#12	PVFT1209IS	Same as above	25	
	34047 *	#13	PVFT1309IS	Same as above	25	
	47049 *	#15	PVFT1509IS	Same as above	25	
	27097 *	#17	PVFT1709IS	Same as above	10	
	79447 *	#18	PVFT1809IS	Same as above	10	
		14934	#3	PVFT030TIS	TEE COVER WITH INSERT , white	100
		14935	#4	PVFT030TIS	Same as above	50
		14936	#5	PVFT030TIS	Same as above	50
		12352	#7	PVFT030TIS	Same as above	50
		12354	#9	PVFT030TIS	Same as above	50
		12355	#10	PVFT030TIS	Same as above	25
12356		#11	PVFT030TIS	Same as above	25	
45905 *		#12	PVFT030TIS	Same as above	25	
34048 *		#13	PVFT030TIS	Same as above	25	
47404 *		#15	PVFT030TIS	Same as above	25	
49520 *		#17	PVFT030TIS	Same as above	10	
65899		#4585	PVACSSTS	TACK FASTENERS , white	500	

* = SPECIAL ORDER ITEM

INSULATION THICKNESS	IRON PIPE SIZE																
	1/2"	3/4"	1"	1-1/4"	1-1/2"	2"	2-1/2"	3"	3-1/2"	4"	5"	6"	8"	10"	12"	14"	16"
1/2"	3	4	5	6	7	9	10	11	12	13	15	17	19	21	--	--	--
1"	7	7	9	9	10	11	12	13	15	15	17	18	20	22	24	25	27
1-1/2"	10	10	11	12	12	13	15	15	17	17	18	19	21	23	25	26	28
2"	12	12	13	13	15	15	17	17	18	18	19	20	22	24	26	27	29
2-1/2"	15	15	15	15	17	17	18	18	19	19	20	21	23	25	27	28	30
3"	17	17	17	17	18	18	19	19	20	20	21	22	24	26	28	29	31
3-1/2"	18	18	18	18	19	19	20	20	21	21	22	23	25	27	29	30	32
4"	19	19	19	19	20	20	21	21	22	22	23	24	26	28	30	31	33
INSULATION THICKNESS	COPPER PIPE SIZE																
	1/2"	3/4"	1"	1-1/4"	1-1/2"	2"	2-1/2"	3"	3-1/2"	4"	5"	6"	--	--	--	--	--
1/2"	3	3	4	5	6	9	10	11	12	13	15	17	--	--	--	--	--
1"	7	7	7	9	9	10	11	12	13	15	17	18	--	--	--	--	--
1-1/2"	9	10	10	11	12	12	13	15	15	17	18	19	--	--	--	--	--
2"	11	12	12	13	13	15	15	17	17	18	19	20	--	--	--	--	--
2-1/2"	13	15	15	15	15	17	17	18	18	19	20	21	--	--	--	--	--
3"	15	17	17	17	17	18	18	19	19	20	21	22	--	--	--	--	--
3-1/2"	--	18	18	18	18	19	19	20	20	21	22	23	--	--	--	--	--
4"	--	19	19	19	19	20	20	21	21	22	23	24	--	--	--	--	--

PLUMBEREX TRAP WRAP



- *Protects against scalding and scraping - meets and exceeds federally mandated requirements of American Disabilities Act 4.19.4*
- *Reusable - maintains full integrity of safety on reinstallation*
- *Universal applications regardless of piping configuration*
- *Eliminates wrapping and provides a clean, professional, and sanitary look*
- *Integral skin, polyurethane foam formulated with anti-microbial additive, 3/8" nominal wall*
- *Prevents condensation by actually insulating p-trap, stop, and supply*
- *ADA compliant*

	ID ORDER#	MODEL #	DESCRIPTION	CTN QTY
	445490	396W	TRAP & SUPPLY WRAP KIT — BAG STYLE , white, consists of (1) P-trap cover and (2) valve and supply cover assemblies	10
	170090	X4114	WHEELCHAIR OFFSET STRAINER COVER , white	10

FOR ADDITIONAL INFORMATION, VISIT THE PLUMBEREX WEBSITE AT www.plumberex.com

GREAT BASIN GREASE INTERCEPTORS



- For indoor use
- Indoor, on-floor, buried, low profile next-to-sink installation
- Includes bolted gas/water tight polypropylene cover with 1,000 pound load rating when unit is buried with FCR1 riser
- Comes ready to connect to 2", 3" or 4" pipe

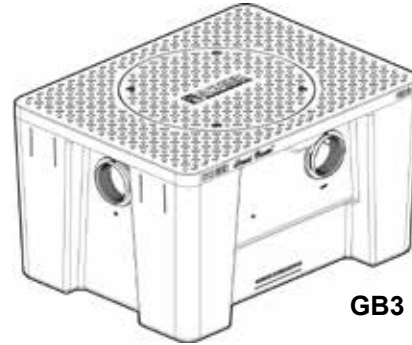

GB3 SERIES

WARRANTY

- Lifetime limited warranty

ID ORDER#	MODEL #	FLOW RATE (GPM)	FPT CONNECTION	PLAIN END ADAPTERS	SOLID CAPACITY (GALLONS)	LIQUID CAPACITY (GALLONS)
GREAT BASIN GREASE INTERCEPTORS						
739983	GB1 (4060-001-04)	20/25	4"	2" or 3"	1.3	10
743820	GB2 (4065-001-05)	35/50	4"	3" or 4"	1.8	20
743821	GB3 (4070-001-04)	50/75	4"	4"	1.9	40

ACCESSORIES



743824 FCR1
(8010-005-01)

FIELD CUT RISER, for GB1, GB2 and GB3, includes polyethylene body, polypropylene top cover ring, EPDM sponge gasket at bottom, silicone fin gasket at top flange; risers allow field adjustability of cover to grade



743825 PP1
(8400-011-02)

PUMPOUT PORT KIT, for GB1, GB2 and GB3, includes internal PVC Schedule 40 1-1/2" piping, PVC Schedule 40 internal fitting adapter, polypropylene retaining nut and 4" x 3" FPT reducer fitting, and standard 3" cam and group fitting with groove cap

FOR ADDITIONAL INFORMATION, VISIT THE SCHIER WEBSITE AT www.schierproducts.com

CLEAR VINYL TUBING & ACCESSORIES

ID ORDER#	MODEL#	DESCRIPTION
30421	T26-187	CLEAR VINYL TUBING , 3/16" ID, 5/16" OD, 100' roll, for condensate drain on condensing furnaces
33931	7-38P	<i>Same as above</i> , but 3/8" ID, 1/2" OD
41484	7-12P	<i>Same as above</i> , but 1/2" ID, 3/4" OD, heavier sidewall tubing resists kinking; intended for use on power-vented 80+ & 90+ units between venter fan and pressure switches
54470	7-58P	<i>Same as above</i> , but 5/8" ID, 7/8" OD, all-purpose tubing
642283	N10-004	NYLON HOSE BARB SPLICER , 3/8"
642284	N10-005	<i>Same as above</i> , but 1/2"
642285	N11-003	NYLON HOSE BARB TEE , 3/8"
642286	N11-005	<i>Same as above</i> , but 1/2"
642282	G08-006	HOSE CLAMP , 5/16"-7/8"

200 SECTION

Plumbing Fixtures — Brass

200 SECTION INDEX

Aker	204-204.2	Mountain Plumbing	218-218.1
American Plumber (Pentair)	227	Mustee	212-212.1
Basco Doors	206-206.1	Oatey	228 (also see 700 section)
Bemis	209-209.1	Pentair	227
Brasscraft	223-223.2 (also see 100 section)	Prier	208
Dayton	211-211.1	Sioux Chief	229 (also see 100 section)
Dearborn Brass & Keeney	222-222.6	Sloan	225-225.1
Delany	226	Speakman	217
Delta	202-202.24	Sterling	201-201.2
Elkay	210-210.3	Stiebel Eltron	231 (also see 400 section)
Fluidmaster	230	T&S Brass	216
Geberit	219	Topp Industries	221
Gerber	215	Zurn	224-224.2 (also see 100 section)
InSinkErator	213-213.3		
Jones-Stephens	230 (also see 100 Section)		
Kohler	200-200.39		
Korky Plus	230		
Legend	230 (also see 100 section)		
Little Giant	220-220.1		
MAAX	205-205.1		
Mansfield	207-207.9		
Metpar	214-214.2		
Moen	203-203.11		

ID	ORDER#	MODEL#	COLOR
----	--------	--------	-------



**ARCHER SINGLE-THRESHOLD SHOWER
BASE, 48" x 36", center drain**

581041	9397-0		White
--------	--------	--	-------

Same as above, but 60" x 36"

581052	9479-0		White
--------	--------	--	-------



**RELY SINGLE-THRESHOLD SHOWER
BASE, 60" x 32", right-hand drain**

725390	8458-0		White
--------	--------	--	-------

Same as above, but left-hand drain

725396	8459-0		White
--------	--------	--	-------



**RELY SINGLE-THRESHOLD SHOWER
BASE, 36" x 34", center drain**

727695	8644-0		White
--------	--------	--	-------

Same as above, but 48" x 34"

725402	8461-0		White
--------	--------	--	-------

Same as above, but 60" x 34"

727683	8649-0		White
--------	--------	--	-------

NOTE: For rough-in specifications and other product features, visit the Kohler website at www.us.kohler.com

KOHLER BATHS & WHIRLPOOLS

THE BOLD LOOK
OF **KOHLER**.

ID	ORDER#	MODEL#	COLOR
	ARCHER BATH , 60" x 30", with integral apron and flange, right-hand drain		
	674936	1946-RA-0	White
Same as above , but left-hand drain			
	674935	1946-LA-0	White

	ARCHER BATH , 60" x 32", with integral apron and flange, right-hand drain		
	580894	1123-RA-0	White
Same as above , but left-hand drain			
	568531	1123-LA-0	White

	BELLWETHER BATH , 60" x 30-1/4", with integral apron, right-hand drain		
	658770	838-0	White
Same as above , but left-hand drain			
	657956	837-0	White

	DEVONSHIRE BATH , 60" x 32", with integral apron and flange, right-hand drain		
	367409	1184-RA-0	White
Same as above , but left-hand drain			
	365408	1184-LA-0	White

	EXPANSE BATH , 60" x 32", with curved integral apron, right-hand drain		
	628297	1100-RA-0	White
Same as above , but left-hand drain			
	628293	1100-LA-0	White

ID	ORDER#	MODEL#	COLOR
	MENDOTA BATH , 60" x 32", with integral apron, right-hand drain		
	114773	506-0	White
Same as above , but left-hand drain			
	114755	505-0	White

	UNDERScore RECTANGLE BATH , 60" x 30", with integral apron and flange, right-hand drain		
	724861	20201-RA-0	White
Same as above , but left-hand drain			
	724837	20201-LA-0	White

	UNDERScore RECTANGLE BATH , 60" x 32", with integral apron and flange, right-hand drain		
	725296	20202-RA-0	White
Same as above , but left-hand drain			
	725294	20202-LA-0	White

	VILLAGER BATH , 60" x 30-1/4", with integral apron, right-hand drain		
	83738	716-0	White
	83740	716-96	Biscuit
Same as above , but left-hand drain			
	83735	715-0	White
	83736	715-96	Biscuit

NOTE: For rough-in specifications and other product features, visit the Kohler website at www.us.kohler.com

KOHLER SELF-RIMMING LAVS

THE BOLD LOOK
OF **KOHLER**.

	ID ORDER#	MODEL#	COLOR
			
ARCHER SELF-RIMMING LAVATORY , single hole, overflow drain			
	580226	2356-1-0	White

			
BRYANT SELF-RIMMING LAVATORY , oval, single hole, overflow drain			
	641859	2699-1-0	White
Same as above , but 4" CC			
	641846	2699-4-0	White

			
FARMINGTON SELF-RIMMING LAVATORY , oval, 4" CC, overflow drain			
	82961	2905-4-0	White
Same as above , but 8" CC			
	83964	2905-8-0	White

			
MEMOIRS STATELY SELF-RIMMING LAVATORY , rectangular, 8" CC, overflow drain			
	109908	2269-8-0	White

	ID ORDER#	MODEL#	COLOR
			
PENNINGTON SELF-RIMMING LAVATORY , oval, single hole, overflow drain			
	85201	2196-1-0	White

Same as above, but 4" CC

	83953	2196-4-0	White
	83813	2196-4-96	Biscuit

Same as above, but 8" CC

	83954	2196-8-0	White
	83815	2196-8-96	Biscuit

			
TIDES SELF-RIMMING LAVATORY , oval, 4" CC, overflow drain			
	642598	2839-4-0	White

NOTE: For rough-in specifications and other product features, visit the Kohler website at www.us.kohler.com

KOHLER

UNDERMOUNT LAVS

THE BOLD LOOK
OF **KOHLER**.

	ID	MODEL#	COLOR
	ORDER#		
	ARCHER UNDERMOUNT LAVATORY, rectangular, overflow drain		
	570503	2355-0	White
	567937	2355-96	Biscuit

	CAXTON UNDERMOUNT LAVATORY, oval, overflow drain		
	108653	2209-0	White
	403786	2209-96	Biscuit

Same as above

	108689	2210-0	White
	108694	2210-47	Almond
	108706	2210-96	Biscuit

	CAXTON UNDERMOUNT LAVATORY, rectangle, overflow drain		
	715047	20000-0	White
	715063	20000-96	Biscuit

	CAXTON UNDERMOUNT LAVATORY, rectangle, overflow drain		
	715047	20000-0	White

	DEVONSHIRE UNDERMOUNT LAVATORY, oval, overflow drain		
	248521	2336-0	White

	KATHRYN UNDERMOUNT LAVATORY, rectangular, overflow drain		
	423986	2297-0	White
	424270	2297-96	Biscuit

	ID	MODEL#	COLOR
	ORDER#		
	LADENA UNDERMOUNT LAVATORY, rectangular, overflow drain		
	421044	2215-0	White

	MEMOIRS UNDERMOUNT LAVATORY, rectangular, overflow drain		
	449000	2339-0	White
	449011	2339-96	Biscuit

	VERTICYL UNDERMOUNT LAVATORY, oval, overflow drain		
	621661	2881-0	White

	VERTICYL UNDERMOUNT LAVATORY, rectangular, overflow drain, 17-1/4" x 13"		
	621660	2882-0	White
	625363	2882-96	Biscuit

Same as above, but 15" x 11"

746921	8189-0	White
--------	--------	-------

	VERTICYL UNDERMOUNT LAVATORY, square, overflow drain		
	744718	8188-0	White

	VERTICYL UNDERMOUNT LAVATORY, rectangular, overflow drain		
	746921	8189-0	White

NOTE: For rough-in specifications and other product features, visit the Kohler website at www.us.kohler.com

WALL-MOUNT & PEDESTAL LAVS

THE BOLD LOOK OF KOHLER.

ID	ORDER#	MODEL#	COLOR
	CHESAPEAKE WALL-MOUNT LAVATORY, single hole, includes wall hanger		
	365371	1722-0	White
Same as above, but 4" CC			
	106214	1728-0	White

	GREENWICH WALL-MOUNT LAVATORY, 4" CC, includes wall hanger		
	83952	2032-0	White
Same as above, but 8" CC			
	84212	2030-0	White

	KINGSTON WALL-MOUNT LAVATORY, single hole, includes wall hanger		
	373079	2007-0	White
Same as above, but 4" CC			
	106448	2005-0	White

	ARCHER PEDESTAL LAVATORY, single hole, overflow drain		
	580317	2359-1-0	White
Same as above, but 8" CC			
	578756	2359-8-0	White

	DEVONSHIRE PEDESTAL LAVATORY, 4" CC, overflow drain		
	165257	2286-4-0	White
	165269	2286-4-96	Biscuit
Same as above, but 8" CC			
	165284	2286-8-96	Biscuit

ID	ORDER#	MODEL#	COLOR
	MEMOIRS CLASSIC PEDESTAL LAVATORY, 8" CC, overflow drain		
	96451	2238-8-0	White

	MEMOIRS STATELY PEDESTAL LAVATORY, 8" CC, overflow drain		
	109864	2268-8-0	White

	MEMOIRS STATELY PEDESTAL LAVATORY, single hole overflow drain		
	757813	2344-1-0	White

	TRESHAM PEDESTAL LAVATORY, single hole, overflow drain		
	733853	2844-1-0	White

	VEER PEDESTAL LAVATORY, 21", single hole, overflow drain		
	714575	5265-1-0	White
Same as above, but 24"			
	757624	5266-1-0	White

NOTE: For rough-in specifications and other product features, visit the Kohler website at www.us.kohler.com

ELONGATED TOILETS — UNLINED
1-PIECE

THE BOLD LOOK OF
KOHLER.

ID	ORDER#	MODEL#	COLOR
 <p>ADAIR COMFORT HEIGHT ELONGATED TOILET—UNLINED, 1-piece, 1.28 gpf, 12" rough-in, includes Quiet-Close seat</p>	668787	3946-0	White

ID	ORDER#	MODEL#	COLOR
 <p>SANTA ROSA COMFORT HEIGHT COMPACT ELONGATED TOILET—UNLINED, 1-piece, 1.28 gpf, 12" rough-in, Revolution 360 technology, includes Quiet-Close seat</p>	769610	30810-0	White

 <p>CIMARRON COMFORT HEIGHT ELONGATED TOILET—UNLINED, 1-piece, concealed trapway, 1.28 gpf, 12" rough-in, includes Quiet-Close seat</p>	703828	3619-0	White
---	--------	--------	-------

 <p>TRESHAM COMFORT HEIGHT COMPACT ELONGATED TOILET—UNLINED, 1-piece, skirted trapway, 1.28 gpf, 12" rough-in (10" and 14" rough-in kits available), includes Quiet-Close seat</p>	690336	3981-0	White
--	--------	--------	-------

 <p>MEMOIRS STATELY COMFORT HEIGHT ELONGATED TOILET—UNLINED, 1-piece, skirted trapway, 1.28 gpf, 12" rough-in, includes Quiet-Close seat and #9167-L-CP trip lever</p>	704303	6428-0	White
---	--------	--------	-------

 <p>ROUGH-IN KIT—14", full skirt trap and attachment system, plastic trapway, for use with #3981 Tresham one-piece toilets</p>	703224	5381-NA	--
	<p>Same as above, but 10" rough-in for use with Tresham, #6428 Memoirs Stately and #6424 Memoirs Classic one-piece toilets</p>		
	703223	5383-NA	--

 <p>REACH COMFORT HEIGHT COMPACT ELONGATED TOILET—UNLINED, 1-piece, skirted trapway, 1.28 gpf, 12" rough-in (10" and 14" rough-in kits available), includes Quiet-Close seat</p>	742563	78080-0	White
--	--------	---------	-------

 <p>SAN SOUCI COMFORT HEIGHT COMPACT ELONGATED TOILET—UNLINED, 1-piece, concealed trapway, 1.28 gpf, 12" rough-in, includes Quiet-Close seat and #9171-L-CP trip lever</p>	694178	5172-0	White
	704773	5172-7	Black

NOTE: For rough-in specifications and other product features, visit the Kohler website at www.us.kohler.com

ELONGATED TOILETS — UNLINED
2-PIECE

THE BOLD LOOK
OF **KOHLER**.

ID
ORDER# MODEL# COLOR

ID
ORDER# MODEL# COLOR



BETELLO COMFORT HEIGHT ELONGATED TOILET—UNLINED, 2-piece, skirted trapway, Revolution 360 flushing technology, 1.28 gpf, 12" rough-in (10" and 14" rough-in kits available), less seat

742183 20197-0 White

Same as above, but with ContinuousClean

740814 20198-0 White



CORBELLE COMFORT HEIGHT ELONGATED TOILET—UNLINED, 2-piece, skirted trapway, 1.28 gpf, 12" rough-in (10" and 14" rough-in kits available), less seat

724579 3814-0 White

737572 3814-96 Biscuit



CIMARRON COMFORT HEIGHT ELONGATED TOILET—UNLINED, 2-piece, skirted trapway, 1.28 gpf, 12" rough-in (10" and 14" rough-in kits available), less seat

717340 5310-0 White

717341 5310-96 Biscuit



CORBELLE COMFORT HEIGHT CONTINUOUSCLEAN ELONGATED TOILET—UNLINED, 2-piece, skirted trapway, Revolution 360 flushing technology, 1.28 gpf, 12" rough-in (10" and 14" rough-in kits available), less seat

733521 5709-0 White



CIMARRON COMFORT HEIGHT ELONGATED TOILET—UNLINED, 2-piece, Revolution 360 flushing technology, 1.28 gpf, 12" rough-in, less seat

747437 31621-0 White

747449 31621-96 Biscuit

Same as above, but with right-hand trip lever

752230 31621-RA-0 White



CORBELLE TALL ELONGATED TOILET—UNLINED, 2-piece, skirted trapway, Revolution 360 flushing technology, 1.28 gpf, 12" rough-in (10" and 14" rough-in kits available), less seat

774995 33813-0 White

Same as above, but with ContinuousClean

775002 33814-0 White



CIMARRON COMFORT HEIGHT ELONGATED TOILET—UNLINED, 2-piece, Revolution 360 flushing technology, 1.6 gpf, 12" rough-in, less seat

756805 31620-0 White



DEVONSHIRE COMFORT HEIGHT ELONGATED TOILET—UNLINED, 2-piece, 1.28 gpf, 12" rough-in, less seat

642913 3837-0 White



CIMARRON COMFORT HEIGHT ELONGATED TOILET—UNLINED, 2-piece, ContinuousClean technologies, Revolution 360 flushing technology, 1.28 gpf, 12" rough-in, less seat

757074 31624-0 White

NOTE: For rough-in specifications and other product features, visit the Kohler website at www.us.kohler.com

ELONGATED TOILETS — UNLINED
2-PIECE

THE BOLD LOOK
OF **KOHLER**.

ID	ORDER#	MODEL#	COLOR
	HIGHLINE CLASSIC COMFORT HEIGHT ELONGATED TOILET—UNLINED , 2-piece, Pressure Lite, 1.6 gpf, 12" rough-in, less seat		
	448140	3493-0	White
448151	3493-96	Biscuit	
Same as above , but with right-hand trip lever			
448154	3493-RA-0	White	

ID	ORDER#	MODEL#	COLOR
	HIGHLINE COMFORT HEIGHT ELONGATED TOILET—UNLINED , 2-piece, 1.6 gpf, 12" rough-in, less seat		
	640772	3979-0	White
640776	3979-96	Biscuit	
Same as above , but with right-hand trip lever			
640778	3979-RA-0	White	

	HIGHLINE COMFORT HEIGHT ELONGATED TOILET—UNLINED , 2-piece, 1.28 gpf, 12" rough-in, less seat		
	640892	3999-0	White
640896	3999-96	Biscuit	
Same as above , but with right-hand trip lever			
640898	3999-RA-0	White	

	HIGHLINE COMFORT HEIGHT DUAL FLUSH ELONGATED TOILET—UNLINED , 2-piece, 1.1 or 1.6 gpf, 12" rough-in, less seat		
	675018	3989-0	White

	HIGHLINE COMFORT HEIGHT ELONGATED TOILET—UNLINED , 2-piece, concealed trapway, 1.28 gpf, 12" rough-in, less seat		
	714073	76301-0	White
714529	76301-96	Biscuit	
Same as above , but with right-hand trip lever			
717353	76301-RA-0	White	

	HIGHLINE TALL HEIGHT ELONGATED TOILET—UNLINED , 2-piece, 1.28 gpf, 12" rough-in, less seat		
	742639	25224-0	White
743359	25224-96	Biscuit	

	HIGHLINE COMFORT HEIGHT ELONGATED TOILET—UNLINED , 2-piece, 1.28 gpf, 10" rough-in, less seat		
	640532	3889-0	White
Same as above , but with right-hand trip lever			
640538	3889-RA-0	White	

	HIGHLINE COMFORT HEIGHT ELONGATED TOILET—UNLINED , 2-piece, 1.28 gpf, 14" rough-in, less seat		
	640676	3949-0	White

NOTE: For rough-in specifications and other product features, visit the Kohler website at www.us.kohler.com

ELONGATED TOILETS — UNLINED
2-PIECE

THE BOLD LOOK
OF **KOHLER**

ID	ORDER#	MODEL#	COLOR
	MEMOIRS STATELY COMFORT HEIGHT ELONGATED TOILET—UNLINED , 2-piece, 1.28 gpf, 12" rough-in, less seat		
	642712	3817-0	White
	642714	3817-96	Biscuit

ID	ORDER#	MODEL#	COLOR
	WELLWORTH STANDARD HEIGHT ELONGATED TOILET—UNLINED , 2-piece, 1.28 gpf, 14" rough-in, less seat		
	640628	3948-0	White

ID	ORDER#	MODEL#	COLOR
	MEMOIRS STATELY COMFORT HEIGHT ELONGATED TOILET—UNLINED , 2-piece, with concealed trapway, 1.28 gpf, 12" rough-in, less seat		
	699767	6669-0	White
	699822	6669-96	Biscuit

ID	ORDER#	MODEL#	COLOR
	WELLWORTH STANDARD HEIGHT ELONGATED TOILET—UNLINED , 2-piece, 1.6 gpf, 12" rough-in, less seat		
	640748	3978-0	White

ID	ORDER#	MODEL#	COLOR
	TRESHAM COMFORT HEIGHT ELONGATED TOILET—UNLINED , 2-piece, 1.28 gpf, 12" rough-in, less seat		
	652084	3950-0	White

ID	ORDER#	MODEL#	COLOR
	WELLWORTH STANDARD HEIGHT DUAL FLUSH ELONGATED TOILET—UNLINED , 2-piece, 1.1 or 1.6 gpf, 12" rough-in, less seat		
	675048	3988-0	White

ID	ORDER#	MODEL#	COLOR
	WELLWORTH CLASSIC STANDARD HEIGHT ELONGATED TOILET—UNLINED , 2-piece, 1.28 gpf, 12" rough-in, less seat		
	449549	3505-0	White
	Same as above , but with right-hand trip lever		
	449563	3505-RA-0	White

ID	ORDER#	MODEL#	COLOR
	WELLWORTH STANDARD HEIGHT ELONGATED TOILET—UNLINED , 2-piece, 1.28 gpf, 12" rough-in, less seat		
	640844	3998-0	White
	Same as above , but with right-hand trip lever		
	640850	3998-RA-0	White

NOTE: For rough-in specifications and other product features, visit the Kohler website at www.us.kohler.com

KOHLER

ELONGATED TOILETS — LINED

2-PIECE

THE BOLD LOOK
OF **KOHLER**.

ID	ORDER#	MODEL#	COLOR
----	--------	--------	-------



**HIGHLINE COMFORT HEIGHT
ELONGATED TOILET—LINED,**
2-piece, 1.28 gpf, 12" rough-in, less seat

640922	3999-U-0	White
--------	----------	-------



**HIGHLINE COMFORT HEIGHT
ELONGATED TOILET—LINED,**
2-piece, 1.28 gpf, 10" rough-in, less seat

640562	3889-U-0	White
--------	----------	-------



**WELLWORTH STANDARD HEIGHT
ELONGATED TOILET—LINED,** 2-piece,
1.28 gpf, 12" rough-in, less seat

640874	3998-U-0	White
640878	3998-U-96	Biscuit

NOTE: For rough-in specifications and other product features, visit the Kohler website at www.us.kohler.com

KOHLER

ROUND TOILETS — UNLINED

2-PIECE



ID	MODEL#	COLOR
----	--------	-------

ID	MODEL#	COLOR
----	--------	-------



CIMARRON COMFORT HEIGHT ROUND TOILET—UNLINED, 2-piece, Revolution 360 flushing technology, 1.28 gpf, 12" rough-in, less seat

748924	31641-0	White
--------	---------	-------

Same as above, but with right-hand trip lever

755343	31641-RA-0	White
--------	------------	-------



MEMOIRS STATELY COMFORT HEIGHT ROUND TOILET—UNLINED, 2-piece, 1.28 gpf, 12" rough-in, less seat

657114	3933-0	White
657118	3933-96	Biscuit



CIMARRON COMFORT HEIGHT ROUND TOILET—UNLINED, 2-piece, Revolution 360 flushing technology, 1.6 gpf, 12" rough-in, less seat

756806	31640-0	White
--------	---------	-------



WELLWORTH STANDARD HEIGHT ROUND TOILET—UNLINED, 2-piece, 1.28 gpf, 12" rough-in, less seat

640796	3997-0	White
--------	--------	-------

Same as above, but with right-hand trip lever

640802	3997-RA-0	White
--------	-----------	-------



CIMARRON COMFORT HEIGHT ROUND TOILET—UNLINED, 2-piece, Continuous-Clean technologies, Revolution 360 flushing technology, 1.28 gpf, 12" rough-in, less seat

757076	31644-0	White
--------	---------	-------



WELLWORTH STANDARD HEIGHT ROUND TOILET—UNLINED, 2-piece, 1.28 gpf, 14" rough-in, less seat

640580	3947-0	White
--------	--------	-------



HIGHLINE COMFORT HEIGHT ROUND TOILET—UNLINED, 2-piece, 1.28 gpf, 12" rough-in, less seat

714860	5481-0	White
714861	5481-96	Biscuit

Same as above, but with right-hand trip lever

714864	5481-RA-0	White
--------	-----------	-------



WELLWORTH STANDARD HEIGHT ROUND TOILET—UNLINED, 2-piece, 1.6 gpf, 12" rough-in, less seat

640724	3977-0	White
--------	--------	-------



MEMOIRS CLASSIC COMFORT HEIGHT ROUND TOILET—UNLINED, 2-piece, 1.28 gpf, 12" rough-in, less seat

657181	3986-0	White
657185	3986-96	Biscuit



WELLWORTH STANDARD HEIGHT DUAL FLUSH ROUND TOILET—UNLINED, 2-piece, 1.1 or 1.6 gpf, 12" rough-in, less seat

675055	3987-0	White
--------	--------	-------

KOHLER

ROUND TOILETS — LINED

2-PIECE



ID	ORDER#	MODEL#	COLOR
----	--------	--------	-------



HIGHLINE COMFORT HEIGHT ROUND TOILET—LINED, 2-piece, 1.28 gpf, 12" rough-in, less seat

731276	5481-U-0	White
731279	5481-U-96	Biscuit



WELLWORTH STANDARD HEIGHT ROUND TOILET—UNLINED, 2-piece, 1.28 gpf, 12" rough-in, less seat

640826	3997-U-0	White
--------	----------	-------

NOTE: For rough-in specifications and other product features, visit the Kohler website at www.us.kohler.com

KOHLER

FLUSH VALVE TOILETS & URINALS

COMMERCIAL



ID	ORDER#	MODEL#	COLOR
	HIGHCLIFF ULTRA ELONGATED BOWL , floor-mount top spud flushometer, 1.1, 1.28 or 1.6 gpf		
	726017	96057-0	White



ID	ORDER#	MODEL#	COLOR
	BARDON HIGH-EFFICIENCY WASHDOWN URINAL , wall-hung, top spud, 0.125-1.0 gpf		
	693796	4991-ET-0	White



	KINGSTON ULTRA ADA ELONGATED BOWL , wall-mount top spud flushometer, 1.1, 1.28 or 1.6 gpf		
	745089	84325-0	White





	DEXTER SIPHON-JET URINAL , wall-hung, top spud, 0.5 or 1.0 gpf		
	83947	5016-ET-0	White





	WELCOMME ULTRA STANDARD HEIGHT ELONGATED BOWL , floor-mount top spud flushometer, 1.1, 1.28 or 1.6 gpf		
	726018	96053-0	White

NOTE: For rough-in specifications and other product features, visit the Kohler website at www.us.kohler.com

ID	ORDER#	MODEL#	COLOR
	BORDER ELONGATED TOILET SEAT , plastic, with anti-microbial agent, Quiet-Close, Grip-Tight bumpers and ReadyLatch hinge		
	753684	24495-A-0	White

	BORDER ROUND TOILET SEAT , plastic, with anti-microbial agent, Quiet-Close, Grip-Tight bumpers and ReadyLatch hinge		
	753686	24494-A-0	White

	BREVIA ELONGATED TOILET SEAT , plastic, with Grip-Tight bumpers and Quick-Release hinges		
	643062	4774-0	White
	643064	4774-47	Almond
	643069	4774-96	Biscuit

	BREVIA ROUND TOILET SEAT , plastic, with Grip-Tight bumpers and Quick-Release hinges		
	643072	4775-0	White
	643074	4775-47	Almond
	643079	4775-96	Biscuit

	CACHET ELONGATED TOILET SEAT , plastic, with ReadyLatch Quiet-Close		
	767568	4636-RL-0	White
	767572	4636-RL-47	Almond
	767570	4636-RL-96	Biscuit

	CACHET ROUND TOILET SEAT , plastic, with ReadyLatch Quiet-Close		
	771915	4639-RL-0	White
	771916	4639-RL-47	Almond
	771917	4639-RL-96	Biscuit

ID	ORDER#	MODEL#	COLOR
	GLISSADE ELONGATED TOILET SEAT , plastic, Quiet-Close, with Grip-Tight bumpers and Quick-Release hinges		
	775006	27331-0	White
	775007	27331-96	Biscuit

	GLISSADE ROUND TOILET SEAT , plastic, Quiet-Close, with Grip-Tight bumpers and Quick-Release hinges		
	778332	27332-0	White
	778333	27332-96	Biscuit

	HYTEN ELEVATED ELONGATED TOILET SEAT , plastic, Quiet-Close, with Grip-Tight bumpers and Quick-Release hinges		
	761642	25875-0	White
	766613	25875-96	Biscuit

	HYTEN ELEVATED ROUND TOILET SEAT , plastic, Quiet-Close, with Grip-Tight bumpers and Quick-Release hinges		
	765350	25876-0	White
	766614	25876-96	Biscuit

	LUSTRA OPEN-FRONT ELONGATED COMMERCIAL TOILET SEAT , solid propylene, with check hinge		
	114294	4670-C-0	White

	LUSTRA OPEN-FRONT ELONGATED "LIFT" TOILET SEAT , solid propylene, with anti-microbial agent and 1" bumpers that lift the seat 2"		
	307310	4679-CA-0	White

NOTE: For rough-in specifications and other product features, visit the Kohler website at www.us.kohler.com

KOHLER

TOILET & BIDET SEATS



ID	MODEL#	COLOR
----	--------	-------

ID	MODEL#	COLOR
----	--------	-------



PUREFRESH ELONGATED TOILET SEAT, plastic, with integrated freshener (carbon filter and assortment scent pack included), programmable 8-hour dual LED nightlight, battery-operated, Quiet-Close, Grip-Tight bumpers, Quick-Release hinges

694026	5588-0	White
--------	--------	-------

Purefresh refill scent packs

696413	7729-NA	Garden Waterfall
--------	---------	------------------

696414	7766-NA	Avocado Spa
--------	---------	-------------



PUREWASH E700 ELONGATED BIDET TOILET SEAT WITH HANDHELD REMOTE CONTROL, plastic, hybrid heater with adjustable temperature settings, stainless steel wand with automatic UV light self-sanitization, LED lighting, front/rear wash modes, adjustable water temperature and pressure, Quiet-Close and Quick-Release hinges

741919	27142-CR-0	White
--------	------------	-------



PUREWASH E545 ELONGATED BIDET TOILET SEAT WITH SIDE PANEL CONTROL, plastic, hybrid heater with 5 adjustable temperature settings, stainless steel wand with automatic UV light self-sanitization, LED lighting, front/rear wash modes, side panel control panel, adjustable water temperature and pressure, Quiet-Close and Grip-Tight bumpers

746958	26132-CSP-0	White
--------	-------------	-------



PUREWASH E750 ELONGATED BIDET TOILET SEAT WITH TOUCHSCREEN REMOTE CONTROL, plastic, in-line heater, stainless steel wand with automatic UV light self-sanitization and adjustable water pressure, temperature and pulsate settings, LED lighting, front/rear wash modes, heated seat with adjustable temperature settings, warm-air drying system with adjustable air speed and temperature, carbon filter odor control, Quiet-Close, Quick-Release hinges, and Grip-Tight bumpers

697829	4108-0	White
--------	--------	-------



PUREWASH E590 ELONGATED BIDET TOILET SEAT WITH SIDE PANEL CONTROL, plastic, hybrid heater with 5 adjustable temperature settings, stainless steel wand with automatic UV light self-sanitization, LED lighting, front/rear wash modes, adjustable water temperature and pressure, oscillating or pulsating spray, warm-air drying system with adjustable air speed and temperature, automatic deodorization, Quiet-Close and Grip-Tight bumpers

715056	8298-0	White
--------	--------	-------



STRONGHOLD ELONGATED TOILET SEAT, solid propylene, with integrated handle and check hinge

478589	4731-C-0	White
--------	----------	-------

NOTE: For rough-in specifications and other product features, visit the Kohler website at www.us.kohler.com

KOHLER

STAINLESS STEEL SINKS

THE BOLD LOOK
OF **KOHLER**.

ID	ORDER#	MODEL#	FINISH	ID	ORDER#	MODEL#	FINISH
		OCTAVE KITCHEN SINK—DOUBLE-EQUAL BOWLS , 32"L x 20-1/4"W x 9"D, undermount, 18 gauge stainless steel				UNDERTONE KITCHEN SINK—SINGLE BOWL , 23"L x 17-1/2"W x 9-1/2"D, undermount, 18 gauge stainless steel	
658872		3843-NA	Stainless Steel	422074		3325-NA	Stainless Steel
		OCTAVE KITCHEN SINK—DOUBLE-EQUAL BOWLS , 33"L x 22"W x 9"D, top-mount/undermount, single hole, 18 gauge stainless steel				UNDERTONE KITCHEN SINK—DOUBLE-EQUAL BOWLS , 31-1/2"L x 18"W x 9-1/2"D, undermount, 18 gauge stainless steel	
658869		3842-1-NA	Stainless Steel	448561		3171-NA	Stainless Steel
		PROLIFIC KITCHEN SINK—SINGLE BOWL WORKSTATION , 33"L x 17-3/4"W x 11"D, undermount, 18 gauge stainless steel, with bamboo cutting board, (2) multi-purpose grated racks, colander and wash bin				UNDERTONE KITCHEN SINK—LARGE/MEDIUM DOUBLE BOWLS , 31"L x 20-1/8"W x 9-1/2"D (left bowl) and 7-1/2"D (right bowl), undermount, 18 gauge stainless steel	
694303		5540-NA	Stainless Steel	448553		3150-NA	Stainless Steel
		Same as above , but 29" x 17-3/4" x 10"				UNDERTONE KITCHEN SINK—DOUBLE-EQUAL BOWLS , 31-1/2" x 18" x 9-1/2" (left bowl) and 7-1/2"D (right bowl), undermount, 18 gauge stainless steel	
727721		23651-NA	Stainless Steel	111200		3351-NA	Stainless Steel
		STACCATO KITCHEN SINK—DOUBLE-EQUAL BOWLS , 33"L x 22"W x 8"D, top-mount, single hole, 18 gauge stainless steel				UNDERTONE LYRIC VEGGIE SINK , 18-3/8"Dia x 7-1/2"D, top-mount/undermount, 18 gauge stainless steel	
358350		3369-1-NA	Stainless Steel	89523		3341-NA	Stainless Steel
		Same as above , but with 4 faucet holes					
217781		3369-4-NA	Stainless Steel				
		STACCATO KITCHEN SINK—LARGE/MEDIUM DOUBLE BOWLS , 33"L x 22"W x 8"D, top-mount, single hole, 18 gauge stainless steel, includes hardwood cutting board					
351264		3361-1-NA	Stainless Steel				
		Same as above , but 4-hole					
207040		3361-4-NA	Stainless Steel				

NOTE: For rough-in specifications and other product features, visit the Kohler website at www.us.kohler.com

KOHLER

STAINLESS STEEL & NEOROC SINKS



ID	MODEL#	FINISH
----	--------	--------

ID	MODEL#	FINISH
----	--------	--------

STAINLESS STEEL SINKS



VAULT KITCHEN SINK—MEDIUM SINGLE BOWL, 25"L x 22"W x 9"D, top-mount/undermount, single hole, 18 gauge stainless steel, includes bottom sink rack

630513 3822-1-NA Stainless Steel



VAULT KITCHEN SINK—LARGE SINGLE BOWL, 33"L x 22"W x 9"D, top-mount/undermount, single hole, 18 gauge stainless steel, includes bottom sink rack

630510 3821-1-NA Stainless Steel

Same as above, but 4-hole

630512 3821-4-NA Stainless Steel



VAULT KITCHEN SINK—DOUBLE-EQUAL BOWLS, 33"L x 22"W x 9"D, top-mount/undermount, single hole, 18 gauge stainless steel, includes bottom sink rack

629474 3820-1-NA Stainless Steel

Same as above, but 4-hole

630509 3820-4-NA Stainless Steel



VAULT KITCHEN SINK—LARGE/MEDIUM DOUBLE BOWLS, 33"L x 22"W x 9"D, top-mount/undermount, single hole, 18 gauge stainless steel, includes bottom sink rack

630516 3823-1-NA Stainless Steel



VAULT KITCHEN SINK—LARGE/MEDIUM DOUBLE BOWLS WITH SMART DIVIDE, 33"L x 22"W x 9"D, top-mount/undermount, single hole, 18 gauge stainless steel, includes bottom sink rack

651221 3839-1-NA Stainless Steel



VAULT ENTERTAINMENT SINK, 15"L x 15"W x 9"D, top-mount/undermount, single hole, 18 gauge stainless steel

651224 3840-1-NA Stainless Steel



VERSE KITCHEN SINK—DOUBLE-EQUAL BOWLS, 33"L x 22"W x 9"D, top-mount, single hole, 18 gauge stainless steel

704977 5267-1-NA Stainless Steel

Same as above, but 4-hole

704979 5267-4-NA Stainless Steel

NEOROC SINKS



CAIRN KITCHEN SINK—LARGE/MEDIUM DOUBLE BOWL, 33-1/2"L x 18-5/16"W x 9-1/2"D (left bowl) and 7-1/2"D (right bowl), undermount, Neoroc composite material, includes bottom sink rack

699443 8204-CM1 Matte Black



CAIRN KITCHEN SINK—SINGLE BOWL, 24-1/2"L x 18-5/16"W x 9-1/2"D, undermount, Neoroc composite material, includes bottom sink rack

733503 28001-CM1 Matte Black

Same as above, but 27-1/2"L

733500 28000-CM1 Matte Black

NOTE: For rough-in specifications and other product features, visit the Kohler website at www.us.kohler.com

KOHLER CAST IRON SINKS

THE BOLD LOOK
OF **KOHLER**.

ID	ORDER#	MODEL#	COLOR
	BROOKFIELD KITCHEN SINK—DOUBLE-EQUAL BOWLS , 33"L x 22"W x 9"D, top-mount, 4-hole, enameled cast iron		
	663894	5846-4-0	White
	663965	5846-4-96	Biscuit

	HARTLAND KITCHEN SINK—DOUBLE-EQUAL BOWLS , 33"L x 22"W x 9"D, top-mount, single hole, enameled cast iron		
	627600	5818-1-0	White
	Same as above , but 4-hole		
	625990	5818-4-96	Biscuit

	IRONRIDGE FARMHOUSE KITCHEN SINK—SINGLE BOWL , 34"L x 22"W x 9"D, undermount, with apron front, enameled cast iron, includes sink rack		
	747898	24268-0	White

	IRON/TONE KITCHEN SINK—DOUBLE-EQUAL BOWLS WITH SMART DIVIDE , 33"L x 18-3/4"W x 9-5/8"D, undermount, enameled cast iron		
	717105	5312-0	White

ID	ORDER#	MODEL#	COLOR
	WHITEHAVEN FARMHOUSE KITCHEN SINK—SINGLE BOWL , 29-11/16"L x 21-9/16"W x 9"D, undermount, with tall apron, enameled cast iron		
	653363	6487-0	White

	WHITEHAVEN FARMHOUSE KITCHEN SINK—SINGLE BOWL , overall size: 35-11/16"L x 21-9/16"W x 9"D, bowl size: 30-3/4"L x 18-1/16"W x 9"D undermount, with apron front, enameled cast iron		
	649451	6489-0	White

	WHITEHAVEN FARMHOUSE KITCHEN SINK—LARGE/MEDIUM DOUBLE BOWLS WITH SMART DIVIDE , inside left bowl size: 18-13/16"L x 18-1/16"W x 9"D, inside right bowl size: 10-5/16"L x 18-1/16"W x 9"D, undermount, with tall apron, enameled cast iron		
	681102	6427-0	White

NOTE: For rough-in specifications and other product features, visit the Kohler website at www.us.kohler.com

KOHLER MEDICINE CABINETS

THE BOLD LOOK
OF **KOHLER**

ID	MODEL#	FINISH
----	--------	--------

ID	MODEL#	FINISH
----	--------	--------



ALUMINUM MEDICINE CABINET—SINGLE DOOR, 20"W x 26"H x 5"D, full-overlay mirrored door with beveled edges, two adjustable tempered-glass shelves, mirrored interior, can be installed with left- or right-hand swing

458318	CB-CLC2026FS	Aluminum
--------	--------------	----------



ARCHER ALUMINUM MEDICINE CABINET—SINGLE DOOR, 20"W x 31"H x 5"D, full-overlay mirrored door with beveled edges, two adjustable tempered-glass shelves, mirrors on back of door and interior back of cabinet, can be installed with left- or right-hand swing

578841	3073-NA	Aluminum
--------	---------	----------



ALUMINUM MEDICINE CABINET—TWO DOOR, 30"W x 26"H x 5"D, full-overlay mirrored doors with beveled edges, two adjustable tempered-glass shelves, mirrored interior, can be installed with left- or right-hand swing

581505	CB-CLC3026FS	Aluminum
--------	--------------	----------



BANCROFT ALUMINUM MEDICINE CABINET—SINGLE DOOR, 20"W x 31"H x 5"D, full-overlay mirrored door with beveled edges, two adjustable tempered-glass shelves, mirrors on back of door and interior back of cabinet, can be installed with left- or right-hand swing

466876	CB-CLC2031BAN	Aluminum
--------	---------------	----------

NOTE: For rough-in specifications and other product features, visit the Kohler website at www.us.kohler.com

KOHLER

KITCHEN FAUCETS

SINGLE HANDLE

THE BOLD LOOK
OF **KOHLER**.

ID	ORDER#	MODEL#	FINISH
	ARTIFACTS SINGLE HANDLE KITCHEN FAUCET WITH PULL-DOWN SPOUT, 3-function sprayhead with Sweep spray		
	695570	99259-CP	Polished Chrome
	695569	99259-VS	Vibrant Stainless
	694298	99259-SN	Vibrant Br. Nickel
694587	99259-2BZ	Oil-Rubbed Bronze	

	BELLERA SINGLE HANDLE KITCHEN FAUCET WITH PULL-DOWN SPOUT, 3-function sprayhead with Sweep spray		
	647572	560-CP	Polished Chrome
	647547	560-VS	Vibrant Stainless
	664288	560-2BZ	Oil-Rubbed Bronze

	BELLERA SINGLE HANDLE SEMI-PROFESSIONAL KITCHEN FAUCET WITH PULL-DOWN SPRAYHEAD, 3-function sprayhead with Sweep spray		
	750798	29106-CP	Polished Chrome
	750799	29106-VS	Vibrant Stainless
	750797	29106-2BZ	Oil Rubbed Bronze

	CORALAIS SINGLE HANDLE KITCHEN FAUCET WITH PULL-OUT SPRAYHEAD		
	204696	15160-CP	Polished Chrome

	CRUE SINGLE HANDLE KITCHEN FAUCET WITH PULL-DOWN SPOUT		
	746695	22972-CP	Polished Chrome
	747461	22972-VS	Vibrant Stainless
	747462	22972-BL	Matte Black

ID	ORDER#	MODEL#	FINISH
	CRUE SINGLE HANDLE KITCHEN FAUCET WITH PULL-OUT SPOUT, 1-hole or 3-hole with escutcheon (included)		
	747840	22976-CP	Polished Chrome
	747481	22976-VS	Vibrant Stainless
	747482	22976-BL	Matte Black

	GRAZE SINGLE HANDLE KITCHEN FAUCET WITH PULL-OUT SPRAYHEAD, 3-function sprayhead with Sweep spray		
	744755	22062-CP	Polished Chrome
	746261	22062-VS	Vibrant Stainless
	745454	22062-BL	Matte Black

	GRAZE SINGLE HANDLE KITCHEN FAUCET WITH PULL-DOWN SPRAYHEAD, 3-function sprayhead with Sweep spray		
	750306	22063-VS	Vibrant Stainless
	750304	22063-BL	Matte Black

	RIFF SINGLE HANDLE KITCHEN FAUCET WITH PULL-DOWN SPOUT, 3-function sprayhead with Sweep spray		
	751728	23830-CP	Polished Chrome
	751726	23830-VS	Vibrant Stainless
	751729	23830-BL	Matte Black

NOTE: For rough-in specifications and other product features, visit the Kohler website at www.us.kohler.com

KOHLER

KITCHEN FAUCETS

SINGLE HANDLE

THE BOLD LOOK
OF **KOHLER**

	ID ORDER#	MODEL#	FINISH
			
RIVAL SINGLE HANDLE KITCHEN FAUCET WITH PULLOUT SPOUT, 2-function sprayhead			
	771512	30468-CP	Polished Chrome

			
RIVAL SINGLE HANDLE KITCHEN FAUCET WITH SIDE SPRAYER			
	772218	30471-CP	Polished Chrome
	772221	30471-VS	Vibrant Stainless

			
SIMPLICE SINGLE HANDLE KITCHEN FAUCET WITH PULL-DOWN SPOUT, 3-function sprayhead with Sweep spray			
	617521	596-CP	Polished Chrome
	617522	596-VS	Vibrant Stainless
	624504	596-BL	Matte Black

			
SIMPLICE SINGLE HANDLE KITCHEN FAUCET WITH PULL-DOWN SPOUT, 3-function sprayhead with Sweep spray			
	568553	647-CP	Polished Chrome
	568664	647-VS	Vibrant Stainless

			
SIMPLICE SINGLE HANDLE SEMI-PROFESSIONAL KITCHEN FAUCET, 3-function sprayhead with Sweep spray			
	726210	22033-CP	Polished Chrome
	730956	22033-VS	Vibrant Stainless
	740195	22033-BL	Matte Black

	ID ORDER#	MODEL#	FINISH
			
TONE SINGLE HANDLE KITCHEN FAUCET WITH PULL-DOWN SPOUT			
	751835	23764-CP	Polished Chrome
	751813	23764-VS	Vibrant Stainless
	751836	23764-BL	Matte Black
	751814	23764-BMB	Matte Black with Modern Brass

			
TONE SINGLE HANDLE SEMI-PROFESSIONAL KITCHEN FAUCET WITH PULL-DOWN SPOUT			
	751815	23765-BL	Matte Black

			
TOURNANT SINGLE HANDLE SEMI-PROFESSIONAL KITCHEN FAUCET, 3-function sprayhead with Sweep spray			
	615575	77515-VS	Vibrant Stainless

NOTE: For rough-in specifications and other product features, visit the Kohler website at www.us.kohler.com

KOHLER

BAR/PREP & LAUNDRY FAUCETS

THE BOLD LOOK
OF **KOHLER**

	ID ORDER#	MODEL#	FINISH
	SIMPLICE SINGLE HANDLE BAR/PREP FAUCET		
	730881	22034-CP	Polished Chrome
	730882	22034-VS	Vibrant Stainless
	740196	22034-BL	Matte Black

	ID ORDER#	MODEL#	FINISH
	SIMPLICE SINGLE HANDLE LAUNDRY FAUCET		
	731004	22035-CP	Polished Chrome
	731005	22035-VS	Vibrant Stainless
	740194	22035-BL	Matte Black

	SIMPLICE SINGLE HANDLE BAR/PREP FAUCET WITH PULL-DOWN SPOUT,		
	3-function sprayhead with Sweep spray		
	617524	597-VS	Polished Chrome

NOTE: For rough-in specifications and other product features, visit the Kohler website at www.us.kohler.com

KOHLER

LAV FAUCETS

SINGLE HANDLE

THE BOLD LOOK
OF **KOHLER**.

	ID	MODEL#	FINISH
	ORDER#		
	CORALAIS SINGLE HANDLE LAV FAUCET, with pop-up drain assembly	15182-4RA-CP	Polished Chrome
	714808		

	ID	MODEL#	FINISH
	ORDER#		
	HONESTY SINGLE HANDLE LAV FAUCET, with pop-up drain assembly	99760-4-BL	Matte Black
	751252		

	CORALAIS SINGLE HANDLE LAV FAUCET — LESS DRAIN , vandal-resistant	15199-4NDRA-CP	Polished Chrome
	716974		

	RIFF SINGLE HANDLE LAV FAUCET, with pop-up drain assembly	27400-4-CP	Polished Chrome
	762190		
	764265	27400-4-BN	Vibrant Br. Nickel
	761640	27400-4-BL	Matte Black

	DEVONSHIRE SINGLE HANDLE LAV FAUCET, with pop-up drain assembly	193-4-CP	Polished Chrome
	693300		
	693301	193-4-BN	Vibrant Br. Nickel
	693302	193-4-2BZ	Oil-Rubbed Bronze

	SIMPLICE SINGLE HANDLE LAV FAUCET, with pop-up drain assembly	27389-4-BL	Matte Black
	769272		

	HINT SINGLE HANDLE LAV FAUCET, with pop-up drain assembly	97060-4-CP	Polished Chrome
	743909		
	743905	97060-4-BN	Vibrant Br. Nickel
	751151	97060-4-BL	Matte Black

	TONE SINGLE HANDLE LAV FAUCET, with pop-up drain assembly	27415-4-BN	Vibrant Br. Nickel
	764257		
	764258	27415-4-BL	Matte Black
	766077	27415-4-2MB	Moderne Br. Brass

NOTE: For rough-in specifications and other product features, visit the Kohler website at www.us.kohler.com

KOHLER LAV FAUCETS TWO HANDLE

THE BOLD LOOK
OF **KOHLER**.

	ID	MODEL#	FINISH
	ORDER#		
	BANCROFT TWO HANDLE MONOBLOCK LAV FAUCET , with pop-up drain assembly		
	447122	10579-4-CP	Polished Chrome
	464142	10579-4-BN	Vibrant Br. Nickel

	CORALAIS TWO HANDLE LAV FAUCET , with pop-up drain assembly		
	716749	15241-4RA-CP	Polished Chrome

	DEVONSHIRE TWO HANDLE LAV FAUCET , with pop-up drain assembly		
	617367	393-N4-CP	Polished Chrome
	623403	393-N4-BN	Vibrant Br. Nickel

	ID	MODEL#	FINISH
	ORDER#		
	HINT TWO HANDLE LAV FAUCET , with pop-up drain assembly		
	751156	97094-4-BL	Matte Black

	KELSTON TWO HANDLE LAV FAUCET , with pop-up drain assembly		
	664277	13490-4-2BZ	Oil-Rubbed Bronze

	SIMPLICE TWO HANDLE LAV FAUCET , with pop-up drain assembly		
	769273	27388-4-CP	Polished Chrome
	769275	27388-4-BL	Matte Black

NOTE: For rough-in specifications and other product features, visit the Kohler website at www.us.kohler.com

KOHLER

WIDESPREAD LAV FAUCETS

TWO HANDLE

THE BOLD LOOK
OF **KOHLER**.

	ID ORDER#	MODEL#	FINISH
		BANCROFT TWO HANDLE WIDESPREAD LAV FAUCET , with pop-up drain assembly	
	447118	10577-4-CP	Polished Chrome
	464136	10577-4-BN	Vibrant Br. Nickel

	ID ORDER#	MODEL#	FINISH
		PARALLEL TWO HANDLE WIDESPREAD LAV FAUCET , with pop-up drain assembly	
	747879	23484-4-PC	Polished Chrome
	747903	23484-4-BN	Vibrant Br. Nickel
	750420	23484-4-BL	Matte Black

		BELLERA TWO HANDLE WIDESPREAD LAV FAUCET , with pop-up drain assembly	
	770734	27380-4-CP	Polished Chrome

		REFINIA TWO HANDLE WIDESPREAD LAV FAUCET , with pop-up drain assembly	
	653229	5317-4-BN	Vibrant Br. Nickel

		DEVONSHIRE TWO HANDLE WIDESPREAD LAV FAUCET , with pop-up drain assembly	
	219071	394-4-CP	Polished Chrome
	360108	394-4-BN	Vibrant Br. Nickel
	658255	394-4-2BZ	Oil-Rubbed Bronze

		RIFF TWO HANDLE WIDESPREAD LAV FAUCET , with pop-up drain assembly	
	764268	27399-4-CP	Polished Chrome
	764267	27399-4-BN	Vibrant Br. Nickel
	764266	27399-4-BL	Matte Black

		HINT TWO HANDLE WIDESPREAD LAV FAUCET , with pop-up drain assembly	
	743913	97093-4-CP	Polished Chrome
	743912	97093-4-BN	Vibrant Br. Nickel
	751581	97093-4-BL	Matte Black

		SIMPLICE TWO HANDLE WIDESPREAD LAV FAUCET , with pop-up drain assembly	
	769276	27390-4-CP	Polished Chrome
	769278	27390-4-BL	Matte Black

		KELSTON TWO HANDLE WIDESPREAD LAV FAUCET , with pop-up drain assembly	
	621568	13491-4-CP	Polished Chrome
	657950	13491-4-2BZ	Oil-Rubbed Bronze

		STONE TWO HANDLE WIDESPREAD LAV FAUCET , with pop-up drain assembly	
	764256	27416-4-BN	Vibrant Br. Nickel
	764256	27416-4-BL	Matte Black

NOTE: For rough-in specifications and other product features, visit the Kohler website at www.us.kohler.com

ID	ORDER#	MODEL#
	PRESSURE BALANCE CARTRIDGE—RITE-TEMP UNIVERSAL , adjustable high temperature limit stop	714404 8305-NA

	PRESSURE BALANCING VALVE BODY AND CARTRIDGE KIT—RITE-TEMP UNIVERSAL , 1/2" universal NPT and direct sweat inlets and outlets	714401 8304-K-NA
	Same as above , but with stops	714402 8304-KS-NA

	PRESSURE BALANCING VALVE BODY AND CARTRIDGE KIT—RITE-TEMP UNIVERSAL , 1/2" universal NPT and direct sweat inlets and outlets and 1/2" PEX crimp connections	714403 8304-PX-NA
--	--	-------------------

	PRESSURE BALANCING VALVE—RITE-TEMP HIFLOW , 3/4", single handle with screwdriver stops, 3/4" NPT connections	635628 2971-KS-NA
---	---	-------------------

	PRESSURE BALANCING VALVE—RITE-TEMP WITH PUSH-BUTTON DIVERTER , 1/2", less screwdriver stops	635558 11748-K-NA
---	--	-------------------

	ROUGH-IN—BATH- OR DECK-MOUNT , 1/2" ceramic high-flow valve system, 15-17 gpm flow rate	85268 300-K-NA
	Same as above , but 3/4" and 25-30 gpm	99766 301-K-NA

ID	ORDER#	MODEL#
	ROUGH-IN—FINISHED DECK- OR RIM-MOUNT WITH BUILT-IN DIVERTER , 1/2" ceramic high-flow valve system, 11-12 gpm flow rate	480415 438-K-NA

	ROUGH-IN—WIDESPREAD IN-WALL , 1/2" ceramic 3-handle valve system with integral diverter and 8" centers	99768 303-K-NA
---	---	----------------

	ROUGH-IN—RITE-TEMP UNIVERSAL DEEP VALVE	714405 10350-NA
---	--	-----------------

	TEST CAP— RITE-TEMP , for #8300 Series valve bodies	714409 10351-NA
--	--	-----------------

	THERMOSTATIC MIXING VALVE—MASTERSHOWER HIGH-FLOW , 1/2" female NPT inlet connections, (1) 1/2" female NPT outlet connection	657008 2972-KS-NA
---	--	-------------------

	THERMOSTATIC MIXING VALVE—MASTERSHOWER XVII HIGH-FLOW , 3/4" female NPT inlet connections, (2) 3/4" female NPT outlet connections	657009 2975-KS-NA
---	--	-------------------

NOTE: For rough-in specifications and other product features, visit the Kohler website at www.us.kohler.com

KOHLER ROUGH-IN VALVES



ID
ORDER# MODEL#



TRANSFER VALVE—MASTERSHOWER
2- OR 3-WAY, (1) 3/4" NPT female inlet connection and (3) 1/2" NPT female outlet connection, single handle operation

634871 728-K-NA



VOLUME CONTROL VALVE—MASTERSHOWER, 1/2" female NPT connections, single handle operation

655499 2974-K-NA

Same as above, but 3/4" connections

655501 2977-K-NA

NOTE: For rough-in specifications and other product features, visit the Kohler website at www.us.kohler.com

KOHLER SHOWER TRIM

THE BOLD LOOK
OF **KOHLER**.

ID	ORDER#	MODEL#	FINISH
	ALTEO SHOWER TRIM , Rite-Temp, 2.5 gpm showerhead		
	653308	TS45106-4-BN	Vibrant Br. Nickel

	BANCROFT SHOWER TRIM , Rite-Temp, 2.5 gpm showerhead		
	447348	TS10583-4-CP	Polished Chrome
	464235	TS10583-4-BN	Vibrant Br. Nickel

	CORALAIS SHOWER TRIM , Rite-Temp, 2.5 gpm showerhead		
	187000	TS15611-4-CP	Polished Chrome

	DEVONSHIRE SHOWER TRIM , Rite-Temp, 2.5 gpm showerhead		
	715126	TS396-4-CP	Polished Chrome
	Same as above , but 1.75 gpm		
	742139	TS396-4G-BN	Vibrant Br. Nickel
	741205	TS396-4G-2BZ	Oil-Rubbed Bronze

	FORTÉ SCULPTED SHOWER TRIM , Rite-Temp, 2.5 gpm showerhead		
	716703	TS10276-4-CP	Polished Chrome
	715984	TS10276-4-BN	Vibrant Br. Nickel

ID	ORDER#	MODEL#	FINISH
	KELSTON SHOWER TRIM , Rite-Temp, 2.5 gpm showerhead		
	621861	TS13493-4-CP	Polished Chrome
	625475	TS13493-4-BN	Vibrant Br. Nickel
	658064	TS13493-4-2BZ	Oil-Rubbed Bronze

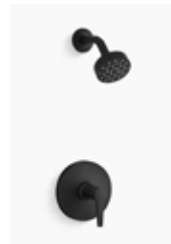
	PITCH SHOWER TRIM , Rite-Temp, 1.75 gpm showerhead		
	749180	TS97077-4G-CP	Polished Chrome
	749178	TS97077-4G-BN	Vibrant Br. Nickel
	749177	TS97077-4G-BL	Matte Black

	RIFF SHOWER TRIM , Rite-Temp, 2.5 gpm showerhead		
	764269	TS27404-4-CP	Polished Chrome
	764270	TS27404-4-BN	Vibrant Br. Nickel
	764271	TS27404-4-BL	Matte Black

	TONE SHOWER TRIM , Rite-Temp, pressure balancing, 2.5 gpm showerhead		
	764260	TS27420-4-BN	Vibrant Br. Nickel
	764261	TS27420-4-BL	Matte Black

NOTE: For rough-in specifications and other product features, visit the Kohler website at www.us.kohler.com

KOHLER

TUB/SHOWER & ROMAN TUB TRIM

THE BOLD LOOK
OF **KOHLER**.

ID	ORDER#	MODEL#	FINISH	ID	ORDER#	MODEL#	FINISH
							
							
							
							
							
							
							
							
							
							
							
							

NOTE: For rough-in specifications and other product features, visit the Kohler website at www.us.kohler.com

SEPTEMBER 2024

Line #1810

KOHLER ROMAN TUB TRIM

200.29

THE BOLD LOOK
OF **KOHLER**.

ID	ORDER#	MODEL#	FINISH
----	--------	--------	--------



BANCROFT ROMAN TUB TRIM, for deck-mount, high-flow valve with non-diverter spout
447356 T10585-4-CP Polished Chrome



FORTÉ ROMAN TUB TRIM, for high-flow valve
239427 T10278-4-CP Polished Chrome



PARALLEL FREESTANDING TUB TRIM
751323 T23492-4-BL Matte Black

NOTE: For rough-in specifications and other product features, visit the Kohler website at www.us.kohler.com

Alpena Branch (989-354-3105)
Burton Branch (810-743-9000)

R. A. Townsend Company
Product Catalog

Saginaw Showroom (989-498-7000)
Warren Branch (586-759-5559)

KOHLER VALVE & DRAIN TRIM

THE BOLD LOOK
OF **KOHLER**.

	ID	MODEL#	FINISH
	ORDER#		
	BANCROFT VALVE TRIM		
	447352	TS10584-4-CP	Polished Chrome
	714414	TS10584-4-BN	Vibrant Br. Nickel

	BANCROFT TRANSFER VALVE TRIM		
	480590	T10595-4-CP	Polished Chrome
	480588	T10595-4-BN	Vibrant Br. Nickel

	DEVONSHIRE VALVE TRIM		
	385548	TS397-4-CP	Polished Chrome
	716712	TS397-4-BN	Vibrant Br. Nickel
	664119	TS397-4-2BZ	Oil-Rubbed Bronze

	DEVONSHIRE TRANSFER VALVE TRIM		
	447371	T376-4-CP	Polished Chrome
	447369	T376-4-BN	Vibrant Br. Nickel
	664396	T376-4-2BZ	Oil-Rubbed Bronze

	FORTÉ SCULPTED VALVE TRIM		
	715985	TS10277-4-CP	Polished Chrome
	714413	TS10277-4-BN	Vibrant Br. Nickel

	FORTÉ SCULPTED TRANSFER VALVE TRIM		
	447323	T10290-4-CP	Polished Chrome
	447321	T10290-4-BN	Vibrant Br. Nickel

	ID	MODEL#	FINISH
	ORDER#		
	PITCH VALVE TRIM		
	751483	TS74042-4-CP	Polished Chrome
	751482	TS74042-4-BN	Vibrant Br. Nickel
	751481	TS74042-4-BL	Matte Black

	PITCH TRANSFER VALVE TRIM		
	751411	T97091-4-CP	Polished Chrome
	751410	T97091-4-BN	Vibrant Br. Nickel
	751409	T97091-4-BL	Matte Black

	PUREFLO ROTARY-TURN BATH DRAIN TRIM, for 37383-NA drain		
	657139	T37391-CP	Polished Chrome
	657137	T37391-BN	Vibrant Br. Nickel
	745341	T37391-BL	Matte Black

NOTE: For rough-in specifications and other product features, visit the Kohler website at www.us.kohler.com

SHOWER COMPONENTS

HANDSHOWER KITS & HANDSHOWERS

THE BOLD LOOK OF
KOHLER.

ID
ORDER# MODEL# FINISH

ID
ORDER# MODEL# FINISH



HANDSHOWER KIT—AWAKEN, multi-function, 2-in-1 combo showerhead, 1.75 gpm
753914 23218-G-CP Polished Chrome
756554 23218-G-BN Vibrant Br. Nickel
756555 23218-G-BL Matte Black



HANDSHOWER—PURIST, multi-function, with Katalyst air-induction technology 2.5 gpm
740254 22166-CP Polished Chrome



HANDSHOWER—SHIFT ECLIPSE, two-function, 2.5 gpm
742231 21336-CP Polished Chrome



HANDSHOWER KIT—BANCROFT, multi-function, 2.5 gpm, with Katalyst air-induction technology
742883 22176-BN Vibrant Br. Nickel



HANDSHOWER—ARTIFACTS, multi-function, with Katalyst air-induction technology
683282 72776-2BZ Oil-Rubbed Bronze





HANDSHOWER—BANCROFT, multi-function, with Katalyst air-induction technology, 2.5 gpm
738236 22163-CP Polished Chrome
738958 22163-BN Vibrant Br. Nickel

NOTE: For rough-in specifications and other product features, visit the Kohler website at www.us.kohler.com

SHOWER COMPONENTS
BODYSPRAYS & SHOWERHEADS

THE BOLD LOOK
OF **KOHLER**.

	ID	MODEL#	FINISH
	BODYSPRAY—WATERTILE ROUND, single-function, 54-nozzle, 2.0 gpm		
	601964	8014-CP	Polished Chrome

	ID	MODEL#	FINISH
	AWAKEN G90 SHOWERHEAD, single-function, 1.75 gpm		
	601964	8014-CP	Polished Chrome

	BODYSPRAY—WATERTILE SQUARE, single-function, 54-nozzle, 2.5 gpm		
	447841	8002-CP	Polished Chrome
	447839	8002-BN	Vibrant Br. Nickel
	Same as above, but 22-nozzle		
	447847	8003-CP	Polished Chrome
	447845	8003-BN	Vibrant Br. Nickel

	SHOWERHEAD—FLIPSIDE, multi-function, wall-mount, 2.5 gpm		
	632741	15996-CP	Polished Chrome
	632739	15996-BN	Vibrant Br. Nickel
	664658	15996-2BZ	Oil-Rubbed Bronze

	RAINHEAD—HONESTY, wall- or ceiling-mount, 2.5 gpm		
	750585	26148-BL	Matte Black

	SHOWERHEAD—FORTÉ, single-function, wall-mount, 2.5 gpm, with Katalyst air-induction technology		
	629926	10282-AK-CP	Polished Chrome
	629924	10282-AK-BN	Vibrant Br. Nickel
	Same as above, but multi-function		
	740271	22169-CP	Polished Chrome

	SHOWERHEAD—PURIST, single-function, wall-mount, 2.5 gpm, with Katalyst air-induction technology		
	629961	965-AK-CP	Polished Chrome

NOTE: For rough-in specifications and other product features, visit the Kohler website at www.us.kohler.com

ID	ORDER#	MODEL#	FINISH
DISPOSAL FLANGE WITH STOPPER			
	392628	11352-CP	Polished Chrome
	392481	11352-BN	Vibrant Br. Nickel
	585303	11352-BS	Brushed Stainless
	664562	11352-2BZ	Oil-Rubbed Bronze
	750159	11352-2MB	Moderne Br. Brass
	733228	11352-BL	Matte Black
DRAIN—BATH (SWIFTFLO), adjustable, 17-gauge brass, for 14" to 16" baths			
	83647	11660-CP	Polished Chrome
Same as above, but 20-gauge brass and for 18-1/2" to 20-1/2" bath			
	100021	11677-CP	Polished Chrome
DRAIN—BATH (CABLE), ClearFlo, less PVC tubing			
	480494	7214-CP	Polished Chrome
	478206	7214-BN	Vibrant Br. Nickel
	664555	7214-2BZ	Oil-Rubbed Bronze
	761890	7214-BL	Matte Black
DRAIN—BATH (CABLE), PureFlo, PVC with tubing			
	657012	37383-NA	--
DRAIN—BATH (SLOTTED), ClearFlo overflow			
	568532	7272-CP	Polished Chrome
	579494	7272-BN	Vibrant Br. Nickel
	663909	7272-2BZ	Oil-Rubbed Bronze
	733293	7272-BL	Matte Black

ID	ORDER#	MODEL#	FINISH
DRAIN—BATH GRID, with overflow			
	480467	7129-A-BN	Vibrant Br. Nickel
	733277	7129-A-BL	Matte Black
DRAIN—POP-UP, ClearFlo adjustable trip lever			
	366074	7160-TF-BN	Vibrant Br. Nickel
DRAIN—POP-UP, ClearFlo adjustable trip lever, with above- or through-the-floor installations for 17"-24" deep baths			
	100440	7161-AF-BN	Vibrant Br. Nickel
DRAIN—TOUCH POP-UP, clicker with overflow			
	480436	7124-A-CP	Polished Chrome
	480433	7124-A-BN	Vibrant Br. Nickel
	664542	7124-A-2BZ	Oil-Rubbed Bronze
	732715	7124-A-BL	Matte Black
DRAIN—TOUCH POP-UP, clicker less overflow			
	480444	7124-CP	Polished Chrome
	480441	7124-BN	Vibrant Br. Nickel
	664541	7124-2BZ	Oil-Rubbed Bronze
	733276	7124-BL	Matte Black

NOTE: For rough-in specifications and other product features, visit the Kohler website at www.us.kohler.com

ID	ORDER#	MODEL#	FINISH
	DRAIN—ADJUSTABLE LINEAR CHASSIS , 1-1/4" x 30"-60"		
757273	32619-NA		
Same as above , but 1-1/2" x 30"-60"			
757272	80646-NA		

	DRAIN—SHOWER (ROUND) , for use with plastic pipe, gasket included		
89666	9132-CP		Polished Chrome
203112	9132-BN		Vibrant Br. Nickel
663912	9132-2BZ		Oil-Rubbed Bronze

	DRAIN—SHOWER (SQUARE) , Clearflo, tile-in with reversible collar to accommodate a variety of tile thicknesses		
603628	9136-CP		Polished Chrome
603626	9136-BN		Vibrant Br. Nickel
663914	9136-2BZ		Oil-Rubbed Bronze
733326	9136-BL		Matte Black
751117	9136-2MB		Vibrant Brushed Moderne Brass

	DRAIN & STRAINER—DUOSTRAINER , with tailpiece		
83926	8801-CP		Polished Chrome
340264	8801-BN		Vibrant Br. Nickel
460102	8801-VS		Vibrant Stainless
664295	8801-2BZ		Oil-Rubbed Bronze
747487	8801-2MB		Moderne Br. Brass
743548	8801-BL		Matte Black

	HANDSHOWER HOLDER—ARTIFACTS , wall-mount, includes supply elbow		
683360	72797-CP		Polished Chrome
683361	72797-BN		Vibrant Br. Nickel
683363	72797-2BZ		Oil-Rubbed Bronze

ID	ORDER#	MODEL#	FINISH
	HANDSHOWER HOLDER—LOURE , wall-mount, with supply elbow		
637594	14791-CP		Polished Chrome
637593	14791-BN		Vibrant Nickel
753980	14791-BL		Matte Black

	MOUNTING BLOCK , for Artifacts, Purist, Stillness, Margaux, Kelston and Composed bath fillers		
696525	97339-NA		--

	SHOWER ARM WITH 3-WAY DIVERTER & FLANGE		
718567	76330-CP		Polished Chrome
718581	76330-BN		Vibrant Br. Nickel

	SHOWER ARM & FLANGE, 5-3/8"		
311266	7395-CP		Polished Chrome

	SHOWER ARM & FLANGE—MASTER-SHOWER, 7-1/2"		
97047	7397-CP		Polished Chrome
330464	7397-BN		Vibrant Br. Nickel
664308	7397-2BZ		Oil-Rubbed Bronze
733307	7397-BL		Matte Black

	SHOWER HOSE—72" MASTERSHOWER		
315873	8593-CP		Polished Chrome
315735	8593-BN		Vibrant Br. Nickel
733320	8593-BL		Matte Black
Same as above , but 60"			
97720	9514-CP		Polished Chrome
316709	9514-BN		Vibrant Br. Nickel
664324	9514-2BZ		Oil-Rubbed Bronze
732126	9514-BL		Matte Black

NOTE: For rough-in specifications and other product features, visit the Kohler website at www.us.kohler.com

ID	ORDER#	MODEL#	FINISH
			
		SINK HOLE COVER , fits 1/2" to 1-1/2" holes	
670214	8830-VS	Vibrant Stainless	

ID	ORDER#	MODEL#	FINISH
			
		SLIDEBAR—30" ADJUSTABLE	
467908	8524-CP	Polished Chrome	
480708	8524-BN	Vibrant Br. Nickel	
658256	8524-2BZ	Oil-Rubbed Bronze	
733319	8524-BL	Matte Black	

ID	ORDER#	MODEL#	FINISH
			
		SLIDEBAR TRIM—FORTÉ/BANCROFT	
480676	349-CP	Polished Chrome	
480674	349-BN	Vibrant Br. Nickel	
658028	349-2BZ	Oil-Rubbed Bronze	

ID	ORDER#	MODEL#	FINISH
			
		SLIDEBAR TRIM—MEMOIRS	
480686	421-CP	Polished Chrome	
480684	421-BN	Vibrant Br. Nickel	

ID	ORDER#	MODEL#	FINISH
		SLIDEBAR TRIM	
762052	1032503-BL	Matte Black	

ID	ORDER#	MODEL#	FINISH
			
		SUPPLY ELBOW—ARTIFACTS , wall-mount	
683366	72796-BN	Vibrant Br. Nickel	

ID	ORDER#	MODEL#	FINISH
			
		SUPPLY ELBOW—AWAKEN , wall-mount	
686348	98350-CP	Polished Chrome	
686347	98350-BN	Vibrant Br. Nickel	
749822	98350-BL	Matte Black	

ID	ORDER#	MODEL#	FINISH
			
		SUPPLY ELBOW—FORTÉ , wall-mount with check valve	
741120	22174-CP	Polished Chrome	
741113	22174-BN	Vibrant Br. Nickel	

ID	ORDER#	MODEL#	FINISH
			
		TRIP LEVER—BETELLO	
742329	21261-L-BN	Vibrant Br. Nickel	
749824	21261-L-BL	Matte Black	

ID	ORDER#	MODEL#	FINISH
			
		TRIP LEVER—CIMARRON , for Cimarron Comfort Height toilets	
249662	9466-L-BN	Vibrant Br. Nickel	
663903	9466-L-2BZ	Oil-Rubbed Bronze	
733331	9466-L-BL	Matte Black	

ID	ORDER#	MODEL#	FINISH
			
		TRIP LEVER—CIMARRON , for Cimarron Revolution 360 toilets	
748291	25986-L-BN	Vibrant Br. Nickel	
748287	25986-L-2BZ	Oil-Rubbed Bronze	
748292	25986-L-BL	Matte Black	

ID	ORDER#	MODEL#	FINISH
			
		TRIP LEVER—CORBELLE	
727219	20120-L-BN	Vibrant Br. Nickel	
744864	20120-L-2BZ	Oil-Rubbed Bronze	
743698	20120-L-BL	Matte Black	

ID	ORDER#	MODEL#	FINISH
			
		TRIP LEVER—MEMOIRS	
653274	9167-L-BN	Vibrant Br. Nickel	
670217	9167-L-2BZ	Oil-Rubbed Bronze	

ID	ORDER#	MODEL#	FINISH
			
		TRIP LEVER—SAN SOUCI	
696500	9171-L-BN	Vibrant Br. Nickel	
746446	9171-L-BL	Matte Black	

NOTE: For rough-in specifications and other product features, visit the Kohler website at www.us.kohler.com

SEPTEMBER 2024

Line #1810

KOHLER MISCELLANEOUS

200.36

THE BOLD LOOK
OF **KOHLER**

ID	ORDER#	MODEL#	FINISH
----	--------	--------	--------



TRIP LEVER—TRESHAM









650913	9375-BN	Vibrant Br. Nickel
663915	9375-2BZ	Oil-Rubbed Bronze









TRIP LEVER—WELLWORTH HIGHLINE

639966	9379-BN	Vibrant Br. Nickel
668859	9379-2BZ	Oil-Rubbed Bronze
733329	9379-BL	Matte Black

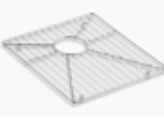
NOTE: For rough-in specifications and other product features, visit the Kohler website at www.us.kohler.com

ID	ORDER#	MODEL#	FINISH
	GRAB BAR—SQUARE, 12"		
	750395	23293-BL	Matte Black
	Same as above, but 24"		
	750401	23295-BL	Matte Black
	Same as above, but 42"		
	750407	23297-BL	Matte Black
	HOTELIER—ELATE		
749153	27294-BL	Matte Black	
	MIRROR—ESSENTIAL ROUND, 28", framed		
	755134	26050-BLL	Matte Black
	ROBE HOOK—DEVONSHIRE		
	239225	10555-CP	Polished Chrome
	388820	10555-BN	Vibrant Br. Nickel
	664377	10555-2BZ	Oil-Rubbed Bronze
	ROBE HOOK—ELATE		
749146	27290-BL	Matte Black	
	ROBE HOOK—SQUARE		
	750386	23290-BL	Matte Black
	SINK RACK—IRONRIDGE, 19-11/16" x 18-1/16" (left rack—holds stacked plates) and 9-3/8" x 18-1/6" (right rack—for utensils), for #24268 Ironridge kitchen sink		
	749581	24269-ST	Stainless Steel
	SINK RACK—IRON/TONE, 14-1/4" x 12-3/16", for either bowl of the #5312 Iron/Tone kitchen sink		
	717836	8339-ST	Stainless Steel

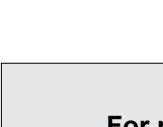
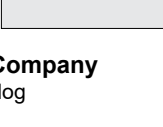
ID	ORDER#	MODEL#	FINISH
	SINK RACK— LANGLADE, 13-1/2" x 15-1/4", for right-hand bowl of #6626 Langlade Smart Divide kitchen sink		
	699814	5180-ST	Stainless Steel
	Same as above, but for left-hand bowl		
	699815	5182-ST	Stainless Steel
	SINK RACK— STACCATO LARGE, 13-1/4" x 15-7/8", for right-hand bowl of #3369 and #3899 Staccato kitchen sinks		
703442	5117-ST	Stainless Steel	
	Same as above, but for left-hand bowl		
	700307	5119-ST	Stainless Steel
	SINK RACK— VAULT, 14" x 15-15/16", for the #3820 Vault kitchen sink		
	642409	6641-ST	Stainless Steel
	SINK RACK— VAULT STRIVE, 15-15/16" x 11-1/16", for the small bowl of the #3823 and #3839 Vault kitchen sinks		
	642397	6647-ST	Stainless Steel
	SINK RACK— WHITEHAVEN, 14-9/16" x 17-5/8", for the large bowl of the #6427 Whitehaven farmhouse kitchen sink		
	683532	5828-ST	Stainless Steel
	Same as above, but 9-1/8" x 14-1/2" and for the small bowl of the #6427 Whitehaven farmhouse kitchen sink		
	683533	5874-ST	Stainless Steel
	SINK RACK— WHITEHAVEN, 14-9/16" x 14-11/16" and 14-1/2" x 14-11/16", for #6489 Whitehaven farmhouse kitchen sink		
	650226	6639-ST	Stainless Steel

NOTE:
For rough-in specifications and other product features, visit the Kohler website at www.us.kohler.com

ID	ORDER#	MODEL#	FINISH
	SINK UTILITY RACK (KITCHEN) , expands to fit most sinks, holds utensils and cleaning tools, doubles as a drying rack for cups and mugs, dishcloth, rail, removable soaking cup, dishwasher safe		
	712848	5473-CHR	Charcoal

	SOAP/LOTION DISPENSER—TRANSITIONAL DESIGN		
	543077	1893-C-CP	Polished Chrome
	562934	1893-C-VS	Vibrant Stainless
	664283	1893-C-2BZ	Oil-Rubbed Bronze

	SOAP/LOTION DISPENSER—TRADITIONAL DESIGN		
	543081	1894-C-CP	Polished Chrome
	542708	1894-C-BN	Vibrant Br. Nickel
	562935	1894-C-VS	Vibrant Stainless

	SOAP/LOTION DISPENSER—CONTEMPORARY DESIGN		
	543088	1895-C-CP	Polished Chrome
	543086	1895-C-BN	Vibrant Br. Nickel
	562936	1895-C-VS	Vibrant Stainless
	630204	1895-BL	Matte Black

	SOAP/LOTION DISPENSER—CONTEMPORARY DESIGN		
	603962	1995-VS	Vibrant Stainless

	TISSUE HOLDER—DEVONSHIRE		
	239220	10554-CP	Polished Chrome
	388105	10554-BN	Vibrant Br. Nickel
	664376	10554-2BZ	Oil-Rubbed Bronze

ID	ORDER#	MODEL#	FINISH
	TISSUE HOLDER—ELATE		
	749150	27292-BL	Matte Black
	Same as above , but vertical		
	749187	27293-BL	Matte Black

	TISSUE HOLDER—SQUARE (VERTICAL)		
	750383	23289-BL	Matte Black

	TISSUE HOLDER—SQUARE		
	750392	23292-BL	Matte Black

	TOWEL ARM—ELATE, 9"		
	749149	27291-BL	Matte Black

	TOWEL ARM—SQUARE, 10"		
	750389	23291-BL	Matte Black

NOTE: For rough-in specifications and other product features, visit the Kohler website at www.us.kohler.com

ID	ORDER#	MODEL#	FINISH
----	--------	--------	--------



TOWEL BAR—DEVONSHIRE, 18"

385545	10550-CP	Polished Chrome
385267	10550-BN	Vibrant Br. Nickel
664372	10550-2BZ	Oil-Rubbed Bronze

Same as above, but 24"

386259	10551-CP	Polished Chrome
385973	10551-BN	Vibrant Br. Nickel
664373	10551-2BZ	Oil-Rubbed Bronze



TOWEL BAR—ELATE, 24"

749092	27287-BL	Matte Black
--------	----------	-------------



TOWEL BAR—SQUARE, 24"

750371	23285-BL	Matte Blac
--------	----------	------------



TOWEL RING—DEVONSHIRE

239230	10557-CP	Polished Chrome
389539	10557-BN	Vibrant Br. Nickel
664378	10557-2BZ	Oil-Rubbed Bronze

NOTE: For rough-in specifications and other product features, visit the Kohler website at www.us.kohler.com



STERLING BATHTUBS & TUB/SHOWERS



ID ORDER#	MODEL#	DIMENSIONS	DESCRIPTION	
	585750	71240120-0	60" x 30" x 72"	ACCORD TUB/SHOWER , <u>white</u> high-gloss finish, Vikrell material, 15" deep bath, two end walls and back wall, pivot "snap together" installation, no sealant or caulk required, <u>right hand drain</u>
	585747	71240110-0	60" x 30" x 72"	Same as above, but <u>white</u> and <u>left hand drain</u>
	463418	71220120-0	60" x 32" x 74"	ENSEMBLE TUB/SHOWER , <u>white</u> high-gloss finish, Vikrell material, 18" deep bath with 2 wainscot/tile ledge, two end walls and back wall with shelf, tongue-and-groove "snap together" installation, some sealant required, <u>right hand drain</u>
	463411	71220110-0	60" x 32" x 74"	Same as above, but <u>white</u> and <u>left hand drain</u>
	695140	71370120-0	60" x 30" x 73"	ENSEMBLE MEDLEY TUB/SHOWER , <u>white</u> high-gloss finish, Vikrell material, 16" deep bath with 2 wainscot/tile ledge, two end walls and back wall with shelf, tongue-and-groove "snap together" installation, no sealant required, <u>right hand drain</u>
	695132	71370110-0	60" x 30" x 73"	Same as above, but <u>white</u> and <u>left hand drain</u>
	746502	71570120-0	60" x 30" x 75"	TRAVERSE SUBWAY TILE TUB/SHOWER , <u>white</u> , high-gloss finish, Vikrell material, 16" deep bath with 2 wainscot/tile ledge, two end walls and two back walls with shelf and subway tile pattern, tongue-and-groove "snap together" installation, no sealant required, <u>right hand drain</u>
	746501	71570110-0	60" x 30" x 75"	Same as above, but <u>white</u> and <u>left hand drain</u>
	746504	71520120-0	60" x 32" x 77"	TRAVERSE SUBWAY TILE TUB/SHOWER , <u>white</u> , high-gloss finish, Vikrell material, 18" deep bath with 2 wainscot/tile ledge, two end walls and two back walls with shelf and subway tile pattern, tongue-and-groove "snap together" installation, no sealant required, <u>right hand drain</u>
	746503	71520110-0	60" x 32" x 77"	Same as above, but <u>white</u> and <u>left hand drain</u>

FOR MORE INFORMATION, VISIT THE STERLING WEBSITE AT www.sterlingplumbing.com

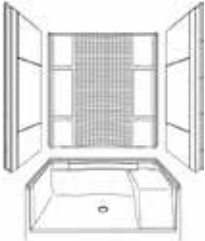
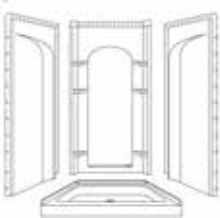
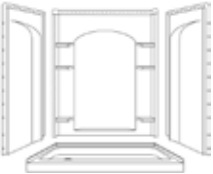



ID ORDER#	MODEL#	DIMENSIONS	DESCRIPTION	
	632944	72280100-0	48" x 36" x 74-1/2"	ACCORD SEATED ALCOVE SHOWER, white , high-gloss finish, Vikrell material, includes shower base, two end walls and back wall, generous storage, curved back wall with lattice pattern, removable seat that can be positioned to the right or left, pivot "snap together" installation, no sealant required, <u>center drain</u>
	632995	72290100-0	60" x 36" x 74-1/2"	Same as above, but <u>white</u> and <u>60" base</u>
	226307	72200100-0	36" x 34" x 75-3/4"	ENSEMBLE CURVE ALCOVE SHOWER, white , high-gloss finish, Vikrell material, includes shower base, two end walls and back wall with shelving, tongue-and-groove "snap together" installation, some sealant required, <u>center drain</u>
	226361	72210100-0	42" x 34" x 75-3/4"	Same as above, but <u>white</u> and <u>42" base</u>
	226410	72220100-0	48" x 34" x 75-3/4"	Same as above, but <u>white</u> and <u>48" base</u>
	226434	72230100-0	60" x 34" x 75-3/4"	Same as above, but <u>white</u> and <u>60" base</u>
	655660	72170120-0	60" x 30" x 75-1/4"	ENSEMBLE END DRAIN SHOWER, white , high-gloss finish, Vikrell material, includes shower base, two end walls and back wall with shelving, tongue-and-groove "snap together" installation, some sealant required, <u>right hand drain</u>
	655658	72170110-0	60" x 30" x 75-1/4"	Same as above, but <u>white</u> and <u>left hand drain</u>
	693656	72180120-0	60" x 32" x 74-3/4"	ENSEMBLE END DRAIN SHOWER, white , high-gloss finish, Vikrell material, includes shower base, two end walls and back wall with shelving, tongue-and-groove "snap together" installation, some sealant required, <u>right hand drain</u>
	693653	72180110-0	60" x 32" x 74-3/4"	Same as above, but <u>white</u> and <u>left hand drain</u>
	201953	62060103-0	63-1/4" x 39-3/8" x 72"	ADA SHOWER, white , swirl-gloss finish, Vikrell material, includes of low profile threshold shower base, two end walls and back wall, factory-installed stainless steel grab bars, tongue-and-groove "snap together" installation, some sealant required

FOR MORE INFORMATION, VISIT THE STERLING WEBSITE AT www.sterlingplumbing.com

STERLING

UTILITY SINKS & ACCESSORIES



	ID ORDER#	MODEL#	DIMENSIONS	DESCRIPTION
UTILITY SINKS				
	567918	995-0	25" x 22" x 12"	LATITUDE SINGLE-BOWL UTILITY SINK— UNDER-MOUNT OR TOP-MOUNT , Vikrell material, 3-1/2" drain opening, white
ACCESSORIES				
	642777	80012222-N	22"	GRAB BAR—CURVED WIDE GRIP , nickel
	642774	80012222-V	22"	<i>Same as above</i> , but matte silver
	642779	80012134-N	34"	<i>Same as above</i> , but 34" and nickel
	642776	80012134-V	34"	<i>Same as above</i> , but matte silver
	642763	80001012-N	12"	GRAB BAR—STRAIGHT GRIP , nickel
	642761	80001012-V	12"	<i>Same as above</i> , but matte silver
	642764	80001018-N	18"	<i>Same as above</i> , but 18" and nickel
	642574	80001018-V	18"	<i>Same as above</i> , but matte silver
	642766	80001024-N	24"	<i>Same as above</i> , but 24" and nickel
	642762	80001024-V	24"	<i>Same as above</i> , but matte silver













FOR MORE INFORMATION, VISIT THE STERLING WEBSITE AT www.sterlingplumbing.com

DELTA

KITCHEN FAUCETS

SINGLE HANDLE



ID	MODEL#	FINISH	ID	MODEL#	FINISH
	ADDISON SINGLE HANDLE PULL-DOWN KITCHEN FAUCET WITH SHIELDSPRAY TECHNOLOGY , high arc gooseneck spout			CLASSIC SINGLE HANDLE KITCHEN FAUCET WITH SIDE SPRAY , standard spout	
636719	9192-DST	Chrome	622127	400-DST	Chrome
636720	9192-RB-DST	Venetian Bronze			
672912	9192-AR-DST	Arctic Stainless			
	BRODERICK SINGLE HANDLE PULL-DOWN KITCHEN FAUCET , high arc goose-neck spout			COLLINS SINGLE HANDLE KITCHEN FAUCET WITH SPRAY , standard spout	
743298	9190-DST	Chrome	622141	440-DST	Chrome
743300	9190-RB-DST	Venetian Bronze	622142	440-SS-DST	Stainless
743295	9190-AR-DST	Arctic Stainless			
	BRODERICK PRO SINGLE HANDLE PULL-DOWN KITCHEN FAUCET , tightly-coiled spring spout			COLLINS SINGLE HANDLE PULL-OUT KITCHEN FAUCET , standard spout	
745216	9690-AR-DST	Arctic Stainless	720035	4140-DST	Chrome
			720037	4140-AR-DST	Arctic Stainless
	CASSIDY SINGLE HANDLE PULL-OUT KITCHEN FAUCET			CORANTO SINGLE HANDLE PULL-DOWN KITCHEN FAUCET , high arc gooseneck spout	
674840	4197-RB-DST	Venetian Bronze	748848	9179-DST	Chrome
674838	4197-AR-DST	Arctic Stainless	748806	9179-AR-DST	Arctic Stainless
			748847	9179-BL-DST	Matte Black
	CASSIDY SINGLE HANDLE PULL-DOWN KITCHEN FAUCET , high arc gooseneck spout			EMMELINE SINGLE HANDLE PULL-DOWN KITCHEN FAUCET , high arc gooseneck spout	
665037	9197-RB-DST	Venetian bronze	748022	9182-PR-DST	Lumicoat Chrome
748496	9197-AR-PR-DST	Lumicoat Arctic Stainless	748206	9182-AR-PR-DST	Lumicoat Stainless
			748021	9182-BL-DST	Matte Black
	CLASSIC SINGLE HANDLE KITCHEN FAUCET , standard spout			ESSA SINGLE HANDLE PULL-DOWN KITCHEN FAUCET , high arc gooseneck spout	
621955	100-DST	Chrome	699630	9113-DST	Chrome
			699372	9113-AR-DST	Arctic Stainless
			699632	9113-BL-DST	Matte Black









NOTE: For rough-in specifications and other product features, visit the Delta website at www.deltafaucet.com

DELTA

KITCHEN FAUCETS

SINGLE HANDLE



ID	ORDER#	MODEL#	FINISH	ID	ORDER#	MODEL#	FINISH
		<i>LELAND SINGLE HANDLE PULL-DOWN KITCHEN FAUCET</i> , high arc spout				<i>MONROVIA SINGLE HANDLE PULL-DOWN KITCHEN FAUCET</i> , high arc gooseneck spout	
	616676	978-DST	Chrome		764345	9191-AR-PR-DST	Lumicoat Actic Stainless
	669237	978-AR-DST	Arctic Stainless				
		<i>LELAND SINGLE HANDLE PULL-DOWN KITCHEN FAUCET WITH SHIELDSPRAY TECHNOLOGY</i> , high arc gooseneck spout				<i>SIGNATURE SINGLE HANDLE PULL-OUT KITCHEN FAUCET</i> , pull-out spout	
	637231	9178-DST	Chrome		637213	470-AR-DST	Arctic Stainless
	637232	9178-RB-DST	Venetian Bronze				
	672336	9178-AR-DST	Arctic Stainless				
		<i>LINDEN SINGLE HANDLE PULL-OUT KITCHEN FAUCET</i> , high arc spout				<i>STRYKE SINGLE HANDLE PULL-DOWN KITCHEN FAUCET</i> , high arc gooseneck spout	
	637206	4153-DST	Chrome		757580	9176-AR-PR-DST	Arctic Stainless
	637207	4153-RB-DST	Venetian Bronze		757582	9176-BL-DST	Matte Black
		<i>LINDEN SINGLE HANDLE PULL-OUT KITCHEN FAUCET</i> , pull-out spout				<i>TRINSIC SINGLE HANDLE PULL-DOWN KITCHEN FAUCET WITH LIMITED SWIVEL</i> , high arc gooseneck spout	
	626085	4353-DST	Chrome		648822	9159-AR-DST	Arctic Stainless
	628350	4353-RB-DST	Venetian Bronze		700170	9159-BL-DST	Matte Black
	672911	4353-AR-DST	Arctic Stainless				
		<i>MATEO SINGLE HANDLE PULL-DOWN KITCHEN FAUCET WITH SHIELDSPRAY TECHNOLOGY</i> , high arc gooseneck spout					
	707091	9183-DST	Chrome				
	707071	9183-RB-DST	Venetian Bronze				
	707090	9183-AR-DST	Arctic Stainless				

NOTE: For rough-in specifications and other product features, visit the Delta website at www.deltafaucet.com

DELTA KITCHEN FAUCETS TWO HANDLE



ID	ORDER#	MODEL#	FINISH
----	--------	--------	--------



CLASSIC TWO HANDLE KITCHEN FAUCET , standard spout			
621986	2102LF		Chrome



CLASSIC TWO HANDLE KITCHEN FAUCET WITH SPRAY , standard spout			
621997	2402LF		Chrome



CASSIDY TWO HANDLE KITCHEN FAUCET WITH SPRAY , high arc spout			
665545	2497LF		Chrome
665541	2497LF-RB		Venetian Bronze
665546	2497LF-AR		Arctic Stainless

NOTE: For rough-in specifications and other product features, visit the Delta website at www.deltafaucet.com

DELTA

BAR/PREP, BEVERAGE & LAUNDRY FAUCETS



ID ORDER#	MODEL#	FINISH
--------------	--------	--------

ID ORDER#	MODEL#	FINISH
--------------	--------	--------

BAR FAUCETS



CLASSIC TWO HANDLE BAR/PREP FAUCET—LESS HANDLES, high arc spout
648724 2172LF-LHP Chrome



FOUNDATIONS TWO HANDLE BAR/PREP FAUCET, high arc spout
634100 B28910LF Chrome



TRADITIONAL SINGLE HANDLE BAR FAUCET, standard spout
697975 1953LF Chrome
695599 1953LF-AR Arctic Stainless

TRANSITIONAL BEVERAGE FAUCET



756014 1920-DST Chrome
756019 1920-RB-DST Venetian Bronze
756015 1920-AR-DST Arctic Stainless

LAUNDRY FAUCETS



CLASSIC TWO HANDLE LAUNDRY FAUCET, standard spout
667624 2131LF Chrome



CLASSIC TWO HANDLE LAUNDRY FAUCET, standard spout
666959 2133LF Chrome

BEVERAGE/BAR FAUCETS



CONTEMPORARY ROUND BEVERAGE FAUCET
756009 1930-DST Chrome
753958 1930-AR-DST Arctic Stainless
756012 1920-BL-DST Matte Black



CONTEMPORARY SQUARE BEVERAGE FAUCET
756020 1940-DST Chrome
756021 1920-AR-DST Arctic Stainless

NOTE: For rough-in specifications and other product features, visit the Delta website at www.deltafaucet.com

DELTA LAV FAUCETS SINGLE HANDLE



ID	ORDER#	MODEL#	FINISH
	ASHLYN SINGLE HANDLE LAV FAUCET, with metal pop-up assembly		
	694340	564-MPU-DST	Chrome
	698045	564-RBMPU-DST	Venetian Bronze
	698046	564-SSMPU-DST	Stainless
	745128	564-BLMPU-DST	Matte Black



ID	ORDER#	MODEL#	FINISH
	DORVAL SINGLE HANDLE LAV FAUCET WITH LEVER HANDLE, with metal pop-up assembly		
	764563	556-BLMPU-DST	Matte Black



	CASSIDY SINGLE HANDLE LAV FAUCET, with metal pop-up assembly		
	667260	597LF-MPU	Chrome
	667262	597LF-RBMPU	Venetian Bronze
	665572	597LF-SSMPU	Stainless



	DRYDEN SINGLE HANDLE LAV FAUCET, with metal pop-up assembly		
	628352	551-DST	Chrome
	628354	551-RB-DST	Venetian Bronze
	628355	551-SS-DST	Stainless



	CLASSIC SINGLE HANDLE CENTERSET LAV FAUCET, with metal pop-up assembly		
	618736	520-MPU-DST	Chrome
	618739	520-SSMPU-DST	Stainless



	KAYRA SINGLE HANDLE PULL-DOWN LAV FAUCET, with metal pop-up assembly		
	749516	533LF-MPU	Chrome
	749527	533LF-SSMPU	Stainless
	748245	533LF-BLPDMPU	Matte Black



	CLASSIC SINGLE HANDLE CENTERSET LAV FAUCET—COMMERCIAL, with metal pop-up assembly		
	649216	523LF-HDF	Chrome



	LAHARA SINGLE HANDLE LAV FAUCET, with metal pop-up assembly		
	633245	538-MPU-DST	Chrome
	633989	538-SSMPU-DST	Stainless



	CLASSIC SINGLE HANDLE LAV FAUCET, with metal pop-up assembly		
	622188	583LF-WF	Chrome
	622187	583LF-SSWF	Stainless



	LINDEN SINGLE HANDLE LAV FAUCET, FAUCET, with metal pop-up assembly		
	653963	594-MPU-DST	Chrome
	653893	594-SSMPU-DST	Stainless

NOTE: For rough-in specifications and other product features, visit the Delta website at www.deltafaucet.com

DELTA LAV FAUCETS SINGLE HANDLE



ID	ORDER#	MODEL#	FINISH
----	--------	--------	--------



**STRYKE SINGLE HANDLE LAV FAUCET—
LESS HANDLE**, with metal pop-up assembly

740752	576-MPU-LHP-DST	Chrome
738982	576-SSMPU-LHP-D	Stainless
740646	576-BLMPU-LHP-D	Matte Black



TRILLIAN SINGLE HANDLE LAV FAUCET,
with metal pop-up assembly

749676	543-MPU-DST	Chrome
--------	-------------	--------



TRINSIC SINGLE HANDLE LAV FAUCET,
with metal pop-up assembly

720268	559LF-BLMPU	Matte Black
--------	-------------	-------------



**TRINSIC SINGLE HANDLE HIGH-ARC LAV
FAUCET**, with metal pop-up assembly

707097	559HA-DST	Chrome
712061	559HA-SS-DST	Stainless
720265	559HA-BL-DST	Matte Black



**WOODHURST SINGLE HANDLE LAV
FAUCET**, single or 3-hole installation, includes
escutcheon and metal pop-up assembly

762571	532-MPU-DST	Chrome
762573	532-RBMPU-DST	Venetian Bronze
762572	532-SSMPU-DST	Stainless
762467	532-BLMPU-DST	Matte Black

NOTE: For rough-in specifications and other product features, visit the Delta website at www.deltafaucet.com

DELTA LAV FAUCETS TWO HANDLE





ID	ORDER#	MODEL#	FINISH
	ASHLYN TWO HANDLE CENTERSET LAV FAUCET , with metal pop-up assembly		
	697981	2564-MPU-DST	Chrome
	697982	2564-RBMPU-DST	Venetian Bronze
	697984	2564-SSMPU-DST	Stainless
	746953	2564-BLMPU-DST	Matte Black

	CLASSIC TWO HANDLE CENTERSET LAV FAUCET , with metal pop-up assembly		
	658429	2523LF-MPU	Chrome

	DRYDEN TWO HANDLE CENTERSET LAV FAUCET , with metal pop-up assembly		
	673008	2551-MPU-DST	Chrome
	673010	2551-SSMPU-DST	Stainless

	KAYRA TWO HANDLE CENTERSET LAV FAUCET , with metal pop-up assembly		
	749533	2533LF-MPU	Chrome
	749532	2551-SSMPU	Stainless
	749531	2533-LF-BLMPU	Matte Black

	LAHARA TWO HANDLE CENTERSET LAV FAUCET , with metal pop-up assembly		
	666756	2538-MPU-DST	Chrome
	669239	2538-SSMPU-DST	Stainless

ID	ORDER#	MODEL#	FINISH
	STRYKE TWO HANDLE CENTERSET LAV FAUCET , with metal pop-up assembly		
	741303	25776-MPU-DST	Chrome

	TRINSIC TWO HANDLE CENTERSET LAV FAUCET , with metal pop-up assembly		
	757477	2559-BLMPU-DST	Matte Black

	WOODHURST TWO HANDLE LAV FAUCET , with metal pop-up assembly		
	742592	2532LF-MPU	Chrome
	737765	2532LF-RBMPU	Venetian Bronze
	734104	2532LF-SSMPU	Stainless
	762569	2532LF-BLMPU	Matte Black

NOTE: For rough-in specifications and other product features, visit the Delta website at www.deltafaucet.com

DELTA

WIDESPREAD LAV FAUCETS TWO HANDLE



ID	ORDER#	MODEL#	FINISH
	ASHLYN TWO HANDLE WIDESPREAD LAV FAUCET WITH EZ ANCHOR , with metal pop-up assembly		
	697988	3564-MPU-DST	Chrome
	697989	3564-RBMPU-DST	Venetian Bronze
	697990	3564-SSMU-DST	Stainless
	745250	3564-BLMPU-DST	Matte Black
	CASSIDY TWO HANDLE WIDESPREAD LAV FAUCET , with metal pop-up assembly		
	667251	3597LF-MPU	Chrome
	666778	3597LF-RBMPU	Venetian Bronze
	CASSIDY TWO HANDLE WIDESPREAD LAV FAUCET—LESS HANDLES , with metal pop-up assembly		
	667245	3595LF-MPU-LHP	Chrome
	CASSIDY TWO HANDLE WIDESPREAD LAV FAUCET—LESS HANDLES , with metal pop-up assembly		
	667247	3595LF-SSMPU-LHP	Stainless
	DRYDEN TWO HANDLE WIDESPREAD LAV FAUCET , with metal pop-up assembly		
	747868	3551-MPU-DST	Chrome
	747871	3551-SSMPU-DST	Stainless
	622080	3551LF-RB	Venetian Bronze

ID	ORDER#	MODEL#	FINISH
	KAYRA TWO HANDLE WIDESPREAD LAV FAUCET , with metal pop-up assembly		
	748609	3533LF-MPU	Chrome
	748612	3533LF-SSMPU	Stainless
	748621	3533LF-BLMPU	Matte Black
	LAHARA TWO HANDLE WIDESPREAD LAV FAUCET , with metal pop-up assembly		
	658451	3538-MPU-DST	Chrome
	658453	3538-SSMPU-DST	Stainless
	TRINSIC TWO HANDLE WIDESPREAD LAV FAUCET , with metal pop-up assembly		
	673038	3559-MPU	Chrome
	673039	3559-SSMPU-DST	Stainless
	720197	3559-BLMPU-DST	Matte Black
	WOODHURST TWO HANDLE WIDESPREAD LAV FAUCET , with metal pop-up assembly		
	738485	3532LF-MPU	Chrome
	738517	3532LF-RBMPU	Venetian Bronze
	738518	3532LF-SSMPU	Stainless
	762562	3532LF-BLMPU	Matte Black

NOTE: For rough-in specifications and other product features, visit the Delta website at www.deltafaucet.com

SEPTEMBER 2024

Line #1550

DELTA TRACT PACKS

202.8



ID	ORDER#	MODEL#	FINISH
----	--------	--------	--------



**CLASSIC SINGLE HANDLE CENTERSET
TRACT PACK LAV FAUCET—LESS DRAIN**











618732	501-TP-DST	Chrome
--------	------------	--------

Same as above, but with drain

618742	520-TPM-DST	Chrome
--------	-------------	--------

NOTE: For rough-in specifications and other product features, visit the Delta website at www.deltafaucet.com



ID ORDER#	MODEL#	ID ORDER#	MODEL#
	ROMAN TUB ROUGH-IN VALVE KIT, 2 handle, flexible mount, 3-hole 441398 R2707		MULTICHOICE UNIVERSAL SHOWER VALVE BODY ROUGH-IN—HIGH FLOW, with 1/2" universal inlets and outlets 466048 R10000-UNBXHF
	TRINSIC SERIES TUB FILLER ROUGH-IN KIT 443022 R4707		MULTICHOICE UNIVERSAL TUB/SHOWER VALVE BODY ROUGH-IN—WITH SCREW-DRIVER STOPS, with 1/2" universal inlets and outlets 466049 R10000-UNWS
	TRINSIC SERIES TUB FILLER ROUGH-IN KIT—FLOOR-MOUNT 674634 R4700-FL		UNIVERSAL TUB/SHOWER DIVERTER ROUGH-IN 634485 R11000
	MULTICHOICE UNIVERSAL TUB/SHOWER ROUGH-IN VALVE—BODY ONLY AND 1/2" PEX CONNECTIONS, with 1/2" universal male thread outlets 474891 R10000-PX		MULTICHOICE UNIVERSAL INTEGRATED SHOWER DIVERTER ROUGH-IN, with universal inlets and outlets 711925 R22000
	MULTICHOICE UNIVERSAL SHOWER ROUGH-IN VALVE—BODY ONLY, PREFAB AND 1/2" PEX CONNECTIONS, with 1/2" universal male thread outlets 727774 R10000-PFS-PX		HYDRACHOICE 1/2" BODY SPRAY ROUGH-IN VALVE 696489 R50200
	MULTICHOICE UNIVERSAL TUB/SHOWER ROUGH-IN VALVE—BODY ONLY, with 1/2" universal inlets and outlets 466048 R10000-UNBX		

NOTE: For rough-in specifications and other product features, visit the Delta website at www.deltafaucet.com

DELTA SHOWER TRIM



ID	ORDER#	MODEL#	FINISH
	ASHLYN SHOWER TRIM , Monitor 14 Series		
	698600	T14264	Chrome
	698602	T14264-RB	Venetian Bronze
	698604	T14264-SS	Stainless
748010	T14264-BL	Matte Black	

	ASHLYN SHOWER TRIM , Monitor 17 Series		
	748374	T17264-BL	Matte Black

	CASSIDY SHOWER TRIM , Monitor 17 Series		
	667379	T17297	Chrome
	667382	T17297-RB	Venetian Bronze
	667383	T17297-SS	Stainless

	CLASSIC SHOWER TRIM , Monitor 13 Series		
	466297	T13220	Chrome

	CLASSIC SHOWER TRIM , Monitor 17 Series		
	466302	T17230	Chrome

ID	ORDER#	MODEL#	FINISH
	DORVAL SHOWER TRIM , Monitor 17 Series		
	744569	T17256	Chrome
	744083	T17256-SS	Stainless
	743396	T17256-BL	Matte Black

	DRYDEN SHOWER TRIM , Monitor 17 Series		
	615574	T17251	Chrome
	618962	T17251-RB	Venetian Bronze
	618960	T17251-SS	Stainless

	KAYRA SHOWER TRIM , Monitor 14 Series		
	749681	T14233	Chrome
	749682	T14233-SS	Stainless
	749623	T14233-BL	Matte Black

	LAHARA SHOWER TRIM , Monitor 14 Series		
	597229	T14238	Chrome
	597232	T14238-SS	Stainless

	LAHARA SHOWER TRIM , Monitor 17 Series		
	597252	T17238	Chrome
	597254	T17238-SS	Stainless

NOTE: For rough-in specifications and other product features, visit the Delta website at www.deltafaucet.com

DELTA SHOWER TRIM



ID	ORDER#	MODEL#	FINISH
	LINDEN SHOWER TRIM , Monitor 14 Series		
	654257	T14294	Chrome

ID	ORDER#	MODEL#	FINISH
	WOODHURST SHOWER TRIM , Monitor 14 Series		
	738884	T14232	Chrome
	747227	T14232-RB	Venetian Bronze
	738885	T14232-SS	Stainless
762563	T14232-BL	Matte Black	

	LINDEN SHOWER TRIM , Monitor 17 Series		
	653953	T17294	Chrome

	STRYKE SHOWER TRIM , Monitor 14 Series		
	741391	T14276	Chrome











	STRYKE SHOWER TRIM , Monitor 17 Series		
	741408	T17276	Chrome
	741410	T17276-SS	Stainless

NOTE: For rough-in specifications and other product features, visit the Delta website at www.deltafaucet.com

DELTA

ROMAN TUB & TUB/SHOWER TRIM



ID	ORDER#	MODEL#	FINISH
	ASHLYN ROMAN TUB TRIM WITH HANDSHOWER		
756109	T4764-BL		Matte Black
	ASHLYN TUB/SHOWER TRIM, Monitor 14 Series		
694177	T14464		Chrome
	694182	T14464-RB	Venetian Bronze
	694183	T14464-SS	Stainless
	ASHLYN TUB/SHOWER TRIM, Monitor 17 Series		
757400	T17464-BL		Matte Black
			
			
	CASSIDY TUB/SHOWER TRIM, Monitor 17 Series		
666776	T17497		Chrome
	667386	T17497-RB	Venetian Bronze
	667387	T17497-SS	Stainless
	CLASSIC TUB/SHOWER TRIM WITH SLIP-ON SPOUT, Monitor 13 Series		
477667	T13420		Chrome
			
			

ID	ORDER#	MODEL#	FINISH
	CLASSIC TUB/SHOWER TRIM WITH SLIP-ON SPOUT, Monitor 17 Series		
477890	T17430		Chrome
			
			
	DORVAL TUB/SHOWER TRIM, Monitor 17 Series		
744571	T17456		Chrome
	744085	T17456-SS	Stainless
	744572	T17456-BL	Matte Black
	DRYEN TUB/SHOWER TRIM, Monitor 17 Series		
618976	T17451		Chrome
	618978	T17451-RB	Venetian Bronze
	616376	T17451-SS	Stainless
	KAYRA TUB/SHOWER TRIM, Monitor 17 Series		
757070	T14433		Chrome
	757068	T14433-SS	Stainless
	757069	T14433-BL	Matte Black
	KAYRA ROMAN TUB TRIM WITH HANDSHOWER		
749534	T4733		Chrome
749539	T4733-SS		Stainless

NOTE: For rough-in specifications and other product features, visit the Delta website at www.deltafaucet.com

DELTA TUB/SHOWER TRIM



ID	ORDER#	MODEL#	FINISH
LAHARA ROMAN TUB TRIM			
	597285	T2738	Chrome
	597288	T2738-SS	Stainless

LAHARA TUB/SHOWER TRIM, Monitor 17 Series			
	597257	T17438	Chrome
	597260	T17438-SS	Stainless

LINDEN TUB/SHOWER TRIM, Monitor 17 Series			
	653955	T17494	Chrome
	653838	T17494-SS	Stainless

STRYKE TUB/SHOWER TRIM, Monitor 17 Series			
	741411	T17476	Chrome
	740440	T17476-SS	Stainless
	741412	T17476-BL	Matte Black

ID	ORDER#	MODEL#	FINISH
TRINSIC TUB/SHOWER TRIM, Monitor 17 Series			
	721067	T17459-BL	Matte Black

WOODHURST TUB/SHOWER TRIM			
	738484	T14432	Chrome
	738489	T14432-RB	Venetian Bronze
	738490	T14432-SS	Stainless
	762565	T14432-BL	Matte Black

NOTE: For rough-in specifications and other product features, visit the Delta website at www.deltafaucet.com

DELTA DIVERTER & VALVE TRIM



ID	ORDER#	MODEL#	FINISH
	ANGULAR MODERN VALVE TRIM , Monitor 14 with 3-setting integrated diverter		
	721110	T24867-SS	Stainless

	ANGULAR MODERN VALVE TRIM , Monitor 17 with 3-setting integrated diverter		
	715723	T27867	Chrome
	711926	T27867-SS	Stainless
743312	T27867-BL	Matte Black	

	ANGULAR MODERN VALVE TRIM , Monitor 17 with 6-setting integrated diverter		
	721130	T27967	Chrome
	721132	T27967-SS	Stainless
	762157	T27967-BL	Matte Black

	ASHLYN DIVERTER TRIM , 3 setting, 2 port		
	698567	T11864	Chrome
	698568	T11864-RB	Venetian Bronze
	698569	T11864-SS	Stainless
	749345	T11864-BL	Matte Black

	ASHLYN VALVE TRIM , Monitor 14 Series		
	698594	T14064-SS	Stainless

	ASHLYN VALVE TRIM , Monitor 17 Series		
	698627	T17064-RB	Venetian Bronze
748618	T17064-BL	Matte Black	

ID	ORDER#	MODEL#	FINISH
	CASSIDY DIVERTER TRIM—LESS HANDLE , 3 setting, 2 port		
	667353	T11897-LHP	Chrome
	667355	T11897-RBLHP	Venetian Bronze
667356	T11897-SSLHP	Stainless	

	CASSIDY VALVE TRIM , Monitor 17 Series		
	666804	T17097	Chrome
	667377	T17097-RB	Venetian Bronze
	667378	T17097-SS	Stainless

	CONTEMPORAR VALVE TRIM , Monitor 17 Series with 3-setting integrated diverter		
	716837	T27859	Chrome
	721125	T27859-SS	Stainless
	743072	T27859-BL	Matte Black

	DORVAL VALVE TRIM , Monitor 17 Series		
	744566	T17056	Chrome
	744568	T17056-SS	Stainless
	743690	T17056-BL	Matte Black

	DORVAL DIVERTER TRIM		
	744544	T11856-BL	Matte Black

NOTE: For rough-in specifications and other product features, visit the Delta website at www.deltafaucet.com

DELTA

DIVERTER & VALVE TRIM







	ID ORDER#	MODEL#	FINISH		ID ORDER#	MODEL#	FINISH
		DRYDEN DIVERTER TRIM , 3 setting, 2 port				SHOWER DIVERTER TRIM , 3 setting, 2 port	
	634436	T11851	Chrome		634428	T11800	Chrome
					634432	T11800-SS	Stainless
		DRYDEN VALVE TRIM , Monitor 17 Series				STRYKE VALVE TRIM	
	615669	T17051	Chrome		741406	T17076	Chrome
	615673	T17051-SS	Stainless				
		KAYRA VALVE TRIM WITH INTEGRATED DIVERTER , two handle, Monitor 17 Series, 3 or 6 setting				STRYKE VALVE TRIM—LESS DIVERTER HANDLE	
	751613	T27833	Chrome		740366	T27876-LHP	Chrome
	751592	T27833-SS	Stainless		740926	T27876-SSLHP	Stainless
	751612	T27833-BL	Matte Black		741442	T27876-BLLHP	Matte Black
		LAHARA VALVE TRIM				TRADITIONAL VALVE TRIM , with 3 setting integrated diverter	
	597223	T14038	Chrome		715880	T27897	Chrome
	588712	T14038-SS	Stainless		715883	T27897-SS	Stainless
		LINDEN DIVERTER TRIM , 3 setting, 2 port				TRINSIC DIVERTER TRIM , 3 setting, 2 port	
	654241	T11894	Chrome		674096	T11859	Chrome
	654243	T11894-RB	Venetian Bronze				
	654244	T11894-SS	Stainless				
		LINDEN VALVE TRIM					
	654273	T17094	Chrome				
	654275	T17094-RB	Venetian Bronze				
	654276	T17094-SS	Stainless				

NOTE: For rough-in specifications and other product features, visit the Delta website at www.deltafaucet.com

DELTA SINGLE HANDLES



ID	ORDER#	MODEL#	FINISH	ID	ORDER#	MODEL#	FINISH
	CASSIDY LEVER HANDLE				INNOVATIONS LEVER HANDLE		
667313	H597		Chrome	84794	H74		Chrome
667316	H597RB		Venetian Bronze				
667317	H597SS		Stainless				
	CLEAR KNOB HANDLE				STRYKE HELO HANDLE		
229212	H11		Clear/Chrome	740753	H551		Chrome
				741307	H551BL		Matte Black
	CLEAR KNOB HANDLE				STRYKE LEVER HANDLE		
383994	H51		Clear/Chrome	739972	H550		Chrome
				738983	H550SS		Stainless
				740647	H550BL		Matte Black
	CLASSIC LEVER HANDLE				STRYKE LEVER HANDLE		
84752	H14		Chrome	740367	H559		Chrome
				740927	H559SS		Stainless
				741372	H559BL		Matte Black
	CLASSIC LEVER HANDLE						
78570	H79		Chrome				

NOTE: For rough-in specifications and other product features, visit the Delta website at www.deltafaucet.com

DELTA HANDLE PAIRS



ID			ID		
ORDER#	MODEL#	FINISH	ORDER#	MODEL#	FINISH
 <p>BLADE HANDLES</p>			 <p>LELAND PORCELAIN LEVER HANDLES</p>		
395008	H28	Chrome	453296	H277	Chrome
 <p>CASSIDY LEVER HANDLES</p>			 <p>LELAND LEVER HANDLES</p>		
667298	H297	Chrome	453295	H278	Chrome
667302	H297SS	Stainless	474667	H278RB	Venetian Bronze
			474668	H278SS	Stainless
 <p>CLEAR KNOB HANDLES</p>					
379800	H61PB	Polished Brass			
 <p>INNOVATIONS LEVER HANDLES</p>					
405578	H24	Chrome			
 <p>INNOVATIONS <u>ROMAN TUB</u> LEVER HANDLES</p>					
408837	H64	Chrome			

NOTE: For rough-in specifications and other product features, visit the Delta website at www.deltafaucet.com

DELTA

SHOWERING COMPONENTS

HANDSHOWER KITS

ACTIVETOUCH HANDSHOWER WITH SLIDE BAR KIT, 9 settings, 2.5 GPM

ID ORDER#	MODEL#	FINISH
742735	51549-BL	Matte Black



DRYDEN HANDSHOWER WITH SLIDE BAR, 1 setting

ID ORDER#	MODEL#	FINISH
648672	57051	Chrome
648766	57051-SS	Stainless Steel



ADJUSTABLE HANDSHOWER WITH SLIDE BAR/GRAB BAR, 4 settings

ID ORDER#	MODEL#	FINISH
745636	51361	Chrome
740515	51361-SS	Stainless Steel



FUNDAMENTALS HANDSHOWER WITH SLIDE BAR, 2 settings

ID ORDER#	MODEL#	FINISH
635680	57011	Chrome



ADJUSTABLE HANDSHOWER WITH SLIDE BAR/GRAB BAR, 2 settings

ID ORDER#	MODEL#	FINISH
655715	52001-DS	White



H₂OKINETIC HANDSHOWER WITH SLIDE BAR, 4 settings

ID ORDER#	MODEL#	FINISH
720098	51140-BL	Matte Black



ADJUSTABLE HANDSHOWER WITH SLIDE BAR/GRAB BAR, 2 settings

ID ORDER#	MODEL#	FINISH
655716	52003-DS	White



H₂OKINETIC HANDSHOWER WITH SLIDE BAR, 3 settings

ID ORDER#	MODEL#	FINISH
664812	51308	Chrome
664815	51308-RB	Venetian Bronze
664816	51308-SS	Stainless

NOTE: For rough-in specifications and other product features, visit the Delta website at www.deltafaucet.com

DELTA

SHOWERING COMPONENTS

HANDSHOWER KITS



	ID ORDER#	MODEL#	FINISH
	H₂OKINETIC HANDSHOWER WITH SLIDE BAR , 5 settings		
	748153	51559-BL	Matte Black

	ID ORDER#	MODEL#	FINISH
	UNIVERSAL HANDSHOWER WITH SLIDE BAR , 5 setting		
	720032	51599-DS	Chrome
	720034	51599-SSDS	Stainless

	KAYRA TUB/SHOWER TRIM WITH IN2ITION HANDSHOWER , Monitor 17		
	749131	T17433-I	Chrome
	749130	T17433-SS-I	Stainless
	749125	T17433-BL-I	Matte Black

	PREMIUM HANDSHOWER WITH SLIDE BAR , 3 settings		
	636547	57014	Chrome
	635208	57014-SS	Stainless

	PREMIUM HANDSHOWER WITH SLIDE BAR , 7 setting		
	655488	51708	Chrome
	655725	51708-SS	Stainless

DELTA

SHOWERING COMPONENTS

HANDSHOWERS



	ID ORDER#	MODEL#	FINISH		ID ORDER#	MODEL#	FINISH
							
		ACTIVETOUCH HANDSHOWER , 9 setting, 2.5 gpm				H₂OKINETIC IN2ITION 2-IN-1 HANDSHOWER , 4 setting	
	743543	59424-BL-PK	Matte Black		720279	58472-BL	Matte Black
		Same as above , but 1.75 gpm					
	747924	59424-BL18-PK	Matte Black				
							
		ACTIVETOUCH HANDSHOWER , 9 setting, 1.75 gpm				H₂OKINETIC IN2ITION 2-IN-1 HANDSHOWER , 5 setting	
	747922	59424-18-PK	Chrome		757587	58474-PR25	Lumicoat Chrome
	747923	59424-SS18-PK	Stainless		741784	58474-RB25	Venetian Bronze
					761836	58474-SS-PR25	Lumicoat Stainless
					741117	58474-BL25	Matte Black
							
		FUNDAMENTALS HANDSHOWER , 2 setting				HANDSHOWER , 3 setting	
	653805	59462-B-PK	Chrome		764654	59386-PR	Lumicoat Chrome
					764655	59386-SS-PR	Lumicoat Stainless
					764653	59386-BL	Matte Black
							
		FUNDAMENTALS FIXED WALL-MOUNT HANDSHOWER , 2 setting				IN2ITION 2-IN-1 HANDSHOWER , 4 setting	
	655711	59410-B-PK	Chrome		601196	58467	Chrome
					655717	58467-SS	Stainless
							
		H₂OKINETIC HANDSHOWER , 3 setting				IN2ITION 2-IN-1 HANDSHOWER , 5 setting	
	664827	59433-PK	Chrome		712131	58569-PK	Chrome
	664830	59433-RB-PK	Venetian Bronze		712132	58569-RB-PK	Venetian Bronze
	664831	59433-SS-PK	Stainless		712133	58569-SS-PK	Stainless
							
		H₂OKINETIC IN2ITION 2-IN-1 HANDSHOWER , 4 setting				IN2ITION 2-IN-1 HANDSHOWER , 5 setting, 2.5 gpm	
	664802	58471-PK	Chrome		765456	58569-SS-PR25-PK	Lumicoat Stainless
	664805	58471-RB-PK	Venetian Bronze				
	664806	58471-SS-PK	Stainless				

NOTE: For rough-in specifications and other product features, visit the Delta website at www.deltafaucet.com

SHOWERING COMPONENTS
HANDSHOWERS & SHOWERHEADS



ID ORDER#	MODEL#	FINISH
PREMIUM HANDSHOWER , 5 setting and pause feature		
738397	59434-18-PK	Chrome
738396	59434-SS18-PK	Stainless

PREMIUM HANDSHOWER , 5 setting		
712148	59436-PK	Chrome
712149	59436-SS-PK	Stainless

PREMIUM HANDSHOWER , 7 setting and pause feature		
712144	59426-PK	Chrome
712145	59426-RB-PK	Venetian Bronze
712146	59426-SS-PK	Stainless

PREMIUM SHOWER MOUNT HANDSHOWER , 7 setting		
712139	59346-PK	Chrome
712141	59346-SS-PK	Stainless

SUREDOCK MAGNETIC HANDSHOWER , 7 setting		
761368	54810-PK	Chrome
761367	54810-SS-PK	Stainless

ID ORDER#	MODEL#	FINISH
H₂OKINETIC ULTRASOAK RAINCAN SHOWERHEAD , 1 setting		
762500	52160-PR25	Lumicoat Chrome
762499	52160-SS-PR25	Lumicoat Stainless
748657	52160-BL25	Matte Black

H₂OKINETIC TRADITIONAL RAINCAN SHOWERHEAD , 5 setting		
765419	52669-PR	Lumicoat Chrome
765420	52669-SS-PR	Lumicoat Stainless
748209	52669-BL	Matte Black

RAINCAN SHOWERHEAD , 1 setting		
629401	RP62283	Chrome
629404	RP62283SS	Stainless
745283	RP62283BL	Matte Black

RAINCAN SHOWERHEAD , 3 setting		
655880	52680	Chrome

RAINCAN SHOWERHEAD , 5 setting		
749220	RP78575-25	Chrome
698515	RP78575RB	Venetian Bronze
698516	RP78575SS	Stainless

NOTE: For rough-in specifications and other product features, visit the Delta website at www.deltafaucet.com

DELTA

SHOWERING COMPONENTS

MISCELLANEOUS



	ID				ID			
	ORDER#	MODEL#	FINISH		ORDER#	MODEL#	FINISH	
	ARM & FLANGE—CEILING MOUNT				SHOWER ARM			
	624117	RP61058	Chrome		5192	RP6023	Chrome	
	623688	RP61058SS	Stainless					
	DIVERTER TUB SPOUT WITH HAND-SHOWER OUTLET				SHOWER ARM			
	655746	U1072-PK	Chrome		566789	RP40593RB	Venetian Black	
					476788	RP40593SS	Stainless	
	655747	U1072-SS	Stainless	720412	RP40593BL	Matte Black		
	GRAB BAR/SLIDE BAR KIT—ADJUSTABLE				SHOWER ARM			
	655310	56302	Chrome		653808	U4929-PK	Chrome	
	655747	56302-SS	Stainless	656035	U4929-RB-PK	Venetian Bronze		
	GRAB BAR/SLIDE BAR KIT—ADJUSTABLE				SHOWER ARM MOUNT—ADJUSTABLE			
	727723	51500	Chrome		655736	U3401-PK	Chrome	
	727735	51500-SS	Stainless		655738	U3401-RB-PK	Venetian Bronze	
	749494	51500-BL	Matte Black		655737	U3401-SS-PK	Stainless	
	GRAB BAR/SLIDE BAR KIT—ADJUSTABLE WITH ELBOW							
	726187	51600	Chrome					
	725861	51600-SS	Stainless					
	748254	51600-BL	Matte Black					

NOTE: For rough-in specifications and other product features, visit the Delta website at www.deltafaucet.com

DELTA

SHOWERING COMPONENTS MISCELLANEOUS



ID ORDER#	MODEL#	FINISH
-----------	--------	--------

SHOWER FLANGE—ROUND



5193	RP6025	Chrome
477354	RP6025RB	Venetian Bronze
477355	RP6025SS	Stainless
720461	RP6025BL	Matte Black

SHOWER FLANGE—SQUARE



634304	RP51034	Chrome
637256	RP51034SS	Stainless
680380	RP51034BL	Matte Black

SHOWER ROD—CURVED, 1" x 6' with 6" bow, includes brackets



754266	42206	Chrome
--------	-------	--------

UNIVERSAL 60-80" STRETCHABLE HOSE



655745	U495D-RB-PK	Venetian Bronze
655542	U495D-SS-PK	Stainless

UNIVERSAL 69-92" STRETCHABLE HOSE



655744	U495D-69-PK	Chrome
--------	-------------	--------

VACUUM BREAKER—ATMOSPHERIC, 1/2"



655741	U4900-PK	Chrome
--------	----------	--------

VOLUME CONTROL



655743	U4760-PK	Chrome
--------	----------	--------

ID ORDER#	MODEL#	FINISH
-----------	--------	--------

WALL MOUNT HOOK—ADJUSTABLE



655739	U4005-PK	Chrome
655740	U4005-RB-PK	Venetian Bronze
655445	U4005-SS-PK	Stainless
758017	U4005-BL-PK	Matte Black

WALL MOUNT ELBOW—ADJUSTABLE



656037	U4985-PK	Chrome
656038	U4985-RB-PK	Venetian Bronze
656039	U4985-SS-PK	Stainless
721171	U4985-BL-PK	Matte Black

WALL SUPPLY ELBOW



758016	50560-PR	Lumicoat Chrome
474183	50560-RB	Venetian Bronze
757794	50560-SS-PR	Lumicoat Stainless
740226	50560-BL	Matte Black

WALL SUPPLY—SQUARE



761817	50570-PR	Lumicoat Chrome
757491	50570-SS-PR	Lumicoat Stainless
720227	50570-BL	Matte Black

NOTE: For rough-in specifications and other product features, visit the Delta website at www.deltafaucet.com



ID	ORDER#	MODEL#	FINISH
----	--------	--------	--------



POWER ADAPTER FOR TOUCH FAUCETS

696706	EP73954	--	
--------	---------	----	--



SOAP DISPENSER—METAL

748085	RP100736	Chrome	
748057	RP100736BL	Matte Black	
744891	RP100736AR	Arctic Stainless	



SOAP DISPENSER—CASSIDY

742751	RP100735RB	Venetian Bronze	
742744	RP100735AR	Arctic Stainless	



SOAP/LOTION DISPENSER—SIGNATURE

169703	RP1001	Chrome	
234559	RP1001SS	Stainless	
637247	RP1001AR	Arctic Stainless	



SOAP/LOTION DISPENSER

641603	RP50781AR	Arctic Stainless	
--------	-----------	------------------	--



SOAP/LOTION DISPENSER

628636	RP50813	Chrome	
628637	RP50813RB	Venetian Bronze	
597994	RP50813SS	Stainless	

TOWEL BAR—KAYRA, 24"

751620	73324-SS	Stainless	
--------	----------	-----------	--







NOTE: For rough-in specifications and other product features, visit the Delta website at www.deltafaucet.com

MOEN

KITCHEN FAUCETS

SINGLE HANDLE



ID	ORDER#	MODEL#	FINISH	ID	ORDER#	MODEL#	FINISH
		ALIGN SINGLE HANDLE KITCHEN FAUCET WITH PULLDOWN SPOUT, 2-function				CAMERIST SINGLE HANDLE KITCHEN FAUCET WITH PULLDOWN SPRAY	
669655	7565SRS	Spot-resist Stainless	566876	7545ORB	Oil-Rubbed Bronze		
		ALIGN SINGLE HANDLE KITCHEN FAUCET WITH PRE-RINSE SPRING PULLDOWN SPOUT, 2-function				CHATEAU SINGLE HANDLE KITCHEN FAUCET	
713196	5923	Chrome	121814	7425	Chrome		
712997	5923SRS	Spot-resist Stainless					
		ARBOR SINGLE HANDLE KITCHEN FAUCET WITH PULLDOWN SPRAY, 1-function				CHATEAU SINGLE HANDLE KITCHEN FAUCET WITH SIDE SPRAY	
666565	7594SRS	Spot-resist Stainless	121822	7430	Chrome		
		ARBOR SINGLE HANDLE KITCHEN FAUCET WITH PULLDOWN SPRAY, 4-function				CHATEAU SINGLE HANDLE KITCHEN FAUCET WITH SIDE SPRAY	
627686	7594C	Chrome	513262	7434	Chrome		
		ARBOR SINGLE HANDLE KITCHEN FAUCET WITH MOTIONSENSE (HANDS FREE) PULLDOWN SPRAY, 3-function				ETCH SINGLE HANDLE KITCHEN FAUCET WITH PULLDOWN SPRAY, 2-function	
666564	7594ESRS	Spot-resist Stainless	691660	S72608SRS	Spot-resist Stainless		
		BELFIELD SINGLE HANDLE KITCHEN FAUCET WITH PULLDOWN SPOUT, 4-function				INTEGRA SINGLE HANDLE KITCHEN FAUCET WITH PULLOUT SPRAY, 2-function	
757758	7260BL	Matte Black	235967	67315C	Chrome		
			684944	67315SRS	Spot-resist Stainless		
		BRANTFORD SINGLE HANDLE KITCHEN FAUCET WITH PULLDOWN SPOUT, 4-function				KURV SINGLE HANDLE KITCHEN FAUCET WITH PULLDOWN SPRAY, 4-function	
684988	7185SRS	Spot-resist Stainless	761784	9126	Chrome		
647048	7185ORB	Oil-Rubbed Bronze	756817	9126SRS	Spot-resist Stainless		
			756941	9126BL	Matte Black		
						Same as above, but with hand wave on/off	
			757118	9126EWBL	Matte Black		

NOTE: For rough-in specifications and other product features, visit the Moen website at www.moen.com

MOEN

KITCHEN FAUCETS

SINGLE and TWO HANDLE



ID	ORDER#	MODEL#	FINISH
----	--------	--------	--------



NIO SINGLE HANDLE KITCHEN FAUCET WITH PULLDOWN SPRAY, 4-function

742921	S75005BL	Matte Black
--------	----------	-------------



PATERSON SINGLE HANDLE INTER-CHANGEABLE KITCHEN FAUCET WITH PULLDOWN SPRAY, 4-function

741822	S72003SRS	Spot-resist Stainless
--------	-----------	-----------------------



SLEEK SINGLE HANDLE KITCHEN FAUCET WITH PULLDOWN SPRAY, 4-function

727235	7864	Chrome
727247	7864BL	Matte Black

TWO HANDLE KITCHEN FAUCETS



BELFIELD TWO-HANDLE KITCHEN FAUCET WITH SIDE SPRAY, 1-function

705495	7255C	Chrome
--------	-------	--------

NOTE: For rough-in specifications and other product features, visit the Moen website at www.moen.com

MOEN LAV FAUCETS SINGLE & TWO HANDLE



ID ORDER#	MODEL#	FINISH
--------------	--------	--------

ID ORDER#	MODEL#	FINISH
--------------	--------	--------

SINGLE HANDLE LAV FAUCETS

TWO HANDLE LAV FAUCETS



BRANTFORD SINGLE HANDLE LAV FAUCET, with metal pop-up drain assembly

618019	6600	Chrome
618020	6600BN	Brushed Nickel
616884	6600ORB	Oil-Rubbed Bronze



BRANTFORD TWO HANDLE LAV FAUCET, with metal pop-up drain assembly

567072	6610	Chrome
567062	6610BN	Brushed Nickel
567063	6610ORB	Oil-Rubbed Bronze



CHATEAU SINGLE HANDLE LAV FAUCET, with metal pop-up drain assembly

71935	L4621	Chrome
-------	-------	--------



DARTMOOR TWO HANDLE LAV FAUCET, with metal pop-up drain assembly

749988	6802BL	Matte Black
--------	--------	-------------



CHATEAU SINGLE HANDLE LAV FAUCET, with metal pop-up drain assembly

513282	L64624	Chrome
--------	--------	--------



DARTMOOR TWO HANDLE WIDESPREAD LAV FAUCET, with metal pop-up drain assembly

757497	T6805BL	Matte Black
--------	---------	-------------



EVA SINGLE HANDLE LAV FAUCET, with metal pop-up drain assembly

617952	6400	Chrome
617951	6400BN	Brushed Nickel
618018	6400ORB	Oil-Rubbed Bronze



EVA TWO HANDLE LAV FAUCET, with metal pop-up drain assembly

513383	6410	Chrome
513382	6410BN	Brushed Nickel



VOSS SINGLE HANDLE LAV FAUCET, with metal pop-up drain assembly

658984	6903	Chrome
658983	6903BN	Brushed Nickel



WYNFORD TWO HANDLE WIDESPREAD LAV FAUCET—WITH LEVER HANDLES, with metal pop-up drain assembly

696087	T4520BN	Brushed Nickel
--------	---------	----------------



WYNFORD SINGLE HANDLE LAV FAUCET, with metal pop-up drain assembly

695692	4500	Chrome
698901	4500ORB	Oil-Rubbed Bronze







WYNFORD TWO HANDLE WIDESPREAD LAV FAUCET—WITH CROSS HANDLES, with metal pop-up drain assembly

696088	T4524BN	Brushed Nickel
--------	---------	----------------



NOTE: For rough-in specifications and other product features, visit the Moen website at www.moen.com



	ID	MODEL#	FINISH
	ORDER#		
	EXACTTEMP ROUGH-IN VALVE , 3/4" IPS connection including volume control	647031	S3600
	M-CORE 3 PORT ROUGH-IN VALVE , 1/2" CC/IPS connection	751564	U130CI
	M-CORE 3 PORT (PEX) ROUGH-IN VALVE , with 1/2" crimp ring PEX connection	752566	U130X
	M-CORE 4 PORT ROUGH-IN VALVE , 1/2" CC/IPS connection	752385	U140CI
	M-CORE 4 PORT (PEX) ROUGH-IN VALVE , with 1/2" crimp ring PEX connection	752567	U140X
	M-CORE TRANSFER ROUGH-IN VALVE , with 1/2" CC/IPS connection	752321	U361CI
	M-CORE TRANSFER (PEX) ROUGH-IN VALVE , with 1/2" crimp ring PEX connection	752569	U361XS
	M-CORE INTEGRATED TRANSFER ROUGH-IN VALVE , with 1/2" CC/IPS connection, <u>includes pressure balancing stops volume control</u>	747959	U362CIS

	ID	MODEL#	FINISH
	ORDER#		
	M-CORE INTEGRATED (PEX) TRANSFER ROUGH-IN VALVE , with 1/2" crimp ring PEX connection, <u>includes pressure balancing stops volume control</u>	752568	U362XS
	M-PACT ROUGH-IN VALVE , Posi-Temp, with 1/2" CC connection including pressure balancing	187573	2520
	M-PACT ROUGH-IN VALVE—WITH STOPS , Posi-Temp, with 1/2" CC connection including pressure balancing	187575	2570
	M-PACT (PEX) ROUGH-IN VALVE , Posi-Temp, with 1/2" crimp ring PEX connection including pressure balancing	665700	2580

ROMAN TUB ROUGH-IN VALVES

	M-PACT TWO HANDLE ROMAN TUB ROUGH-IN VALVE , with adjustable 1/2" CC connection	664104	4792
	M-PACT TWO HANDLE ROMAN TUB ROUGH-IN VALVE , with adjustable 1/2" CC connection	665682	9792

WIDESPREAD ROUGH-IN VALVES

	M-PACT WIDESPREAD ROUGH-IN VALVE , 8"-16" center, 1/2" IPS connection	197777	9000
---	--	--------	------

NOTE: For rough-in specifications and other product features, visit the Moen website at www.moen.com

MOEN

SHOWER & TUB/SHOWER TRIM KITS



ID ORDER#	MODEL#	FINISH	ID ORDER#	MODEL#	FINISH
	BELFIELD M-CORE 2 SERIES TUB/SHOWER TRIM, 1.75 GPM			EVA TUB/SHOWER TRIM, Posi-Temp, 2.5 gpm	
757496	UT2313EPNL	Polished Nickel	517678	T2133	Chrome
			517677	T2133BN	Brushed Nickel
			517679	T2133ORB	Oil-Rubbed Bronze
	BRANTFORD VALVE TRIM, Posi-Temp			VOSS SHOWER TRIM, Posi-Temp, 2.5 gpm	
567080	T2151	Chrome	659008	T2692	Chrome
	BRANTFORD SHOWER TRIM, Posi-Temp, 2.5 gpm			VOSS SHOWER TRIM, Posi-Temp, 2.5 gpm	
567083	T2152	Chrome	659007	T2692BN	Brushed Nickel
567085	T2152BN	Brushed Nickel		VOSS TUB/SHOWER TRIM, Posi-Temp, 2.5 gpm	
567084	T2152ORB	Oil-Rubbed Bronze	659017	T2693	Chrome
	BRANTFORD TUB/SHOWER TRIM, Posi-Temp, 2.5 gpm			VOSS TUB/SHOWER TRIM, Posi-Temp, 2.5 gpm	
567086	T2153	Chrome	659016	T2693BN	Brushed Nickel
567088	T2153BN	Brushed Nickel		WYNFORD M-CORE 3-SERIES TUB/SHOWER TRIM, 2.5 gpm	
567087	T2153ORB	Oil-Rubbed Bronze	753324	UT35503BN	Brushed Nickel
	EVA SHOWER TRIM, Posi-Temp, 2.5 gpm				
517674	T2132	Chrome			
517673	T2132BN	Brushed Nickel			
517675	T2132ORB	Oil-Rubbed Bronze			

NOTE: For rough-in specifications and other product features, visit the Moen website at www.moen.com



ID	ORDER#	MODEL#	FINISH
----	--------	--------	--------



BRANTFORD WIDESPREAD TWO-HANDLE HIGH ARC LAV FAUCET

566767	T6620	Chrome
566742	T6620BN	Brushed Nickel
566746	T6620ORB	Oil-Rubbed Bronze



EVA WIDESPREAD TWO-HANDLE HIGH ARC LAV FAUCET

517691	T6420	Chrome
517690	T6420BN	Brushed Nickel
517692	T6420ORB	Oil-Rubbed Bronze



VOSS WIDESPREAD TWO-HANDLE LAV FAUCET, 8-16" center, 3-hole

659026	T6905	Chrome
659025	T6905BN	Brushed Nickel

NOTE: For rough-in specifications and other product features, visit the Moen website at www.moen.com



ID	ORDER#	MODEL#	FINISH
----	--------	--------	--------



M-PACT ROUGH-IN VALVE—WITH STOPS,
Posi-Temp, with 1/2" CC connection including
pressure balancing

31494	62320	Chrome
-------	-------	--------

Same as above, but with stops

38257	62370	Chrome
-------	-------	--------



CHATEAU SHOWER TRIM, Posi-Temp,
2.5 gpm

71941	TL182	Chrome
-------	-------	--------



CHATEAU TUB/SHOWER TRIM, Posi-Temp,
2.5 gpm

71942	TL183	Chrome
-------	-------	--------

NOTE: For rough-in specifications and other product features, visit the Moen website at www.moen.com

MOEN HANDSHOWERS & SPRAYHEADS



ID	MODEL#	FINISH
----	--------	--------

ID	MODEL#	FINISH
----	--------	--------

HANDHELD SHOWERS



ENGAGE MAGNETIX ECO-PERFORMANCE HANDHELD SHOWER, 1.75 gpm, 5-1/2" spray head

732379	3662EP	Chrome
732380	3662EPBN	Brushed Nickel
732324	3662EPORB	Oil-Rubbed Bronze
747280	3662EPBL	Matte Black



ENGAGE MAGNETIX ECO-PERFORMANCE HANDHELD SHOWER, 1.75 gpm, 3-1/2" spray head

713945	26100EP	Chrome
713882	26100EPSRN	Spot-resist Brushed Nickel



TWIST MULTI-FUNCTION HANDHELD SHOWER, with 4 spray patterns

665893	160042	Chrome
666427	160042ORB	Oil-Rubbed Bronze

SPRAY HEADS



RAINSHOWER SPRAY HEAD—ONE FUNCTION, 7" diameter

646738	S6310BN	Brushed Nickel
--------	---------	----------------







STANDARD SPRAY HEAD—FOUR FUNCTION, 2.5 gpm, 4-3/8" spray head

684773	3638BN	Brushed Nickel
--------	--------	----------------

NOTE: For rough-in specifications and other product features, visit the Moen website at www.moen.com



	ID ORDER#	MODEL#	FINISH
		ADAPTER KIT , for Motionsense faucet	
	713586	169031	
		DIVERTER SPOUT , slip fit	
	124084	3807	Chrome
		REMOTE DOCK—MAGNETIX	
	756755	186117	Chrome
	749675	186117BN	Brushed Nickel
	749635	186117ORB	Oil-Rubbed Bronze
	749674	186117BL	Matte Black
		SHOWER DRAIN COVER , 4-1/4", for 825-2P drain	
	513174	101664BN	Brushed Nickel
	513177	101664ORB	Oil-Rubbed Bronze
	513180	101664WR	Wrought Iron
	734834	101664BG	Brushed Gold
		SHOWER HOSE , 69"	
	618618	A726BR	Brown

	ID ORDER#	MODEL#	FINISH
		SOAP/LOTION DISPENSER	
	617638	3942	Chrome
	666529	3942SRS	Spot-resist Stainless
		SOAP/LOTION DISPENSER	
	614093	3944ORB	Oil-Rubbed Bronze
		SOAP DISPENSER—TRADITIONAL	
	696012	S3946SRS	Spot-resist Stainless
	748217	S3945BL	Matte Black
		VOSS DOUBLE ROBE HOOK	
	659032	YB5103CH	Chrome
	659031	YB5103BN	Brushed Nickel
		VOSS TOWEL BAR , 18"	
	659038	YB5118CH	Chrome
	659037	YB5118BN	Brushed Nickel

NOTE: For rough-in specifications and other product features, visit the Moen website at www.moen.com

MOEN ACCESSORIES (CSI DONNER)



ID	ORDER#	MODEL#	FINISH
GRAB BAR—ELEGANCE, 16"			
	518997	R8716D1GCH	Chrome
	518996	R8716D1GBN	Brushed Nickel
Same as above, but 24"			
	519007	LR8724D1GCH	Chrome
	519006	LR8724D1GBN	Brushed Nickel
	519008	LR8724D1GOWB	Old World Bronze

GRAB BAR—HOME CARE, 12"			
	655440	R8712W	Glacier White
Same as above, but 18"			
	519074	R8718W	Glacier White
Same as above, but 24"			
	519076	R8724W	Glacier White

GRAB BAR—KINGSLEY, 12"			
	519434	YG5412CH	Chrome
	519433	YG5412BN	Brushed Nickel
	519436	YG5412ORB	Oil-Rubbed Bronze
Same as above, but 18"			
	519438	YG5418CH	Chrome
	519437	YG5418BN	Brushed Nickel
	519439	YG5418ORB	Oil-Rubbed Bronze
Same as above, but 24"			
	519441	YG5424CH	Chrome
	519440	YG5424BN	Brushed Nickel
	519442	YG5424ORB	Oil-Rubbed Bronze
Same as above, but 18"			
	519447	YG5436CH	Chrome
	519446	YG5436BN	Brushed Nickel

ID	ORDER#	MODEL#	FINISH
GRAB BAR—ULTIMA, 16"			
	519002	LR8716D3CH	Chrome
Same as above, but 24"			
	519012	LR8724D3CH	Chrome

GRAB BAR—ULTIMA WITH CURL GRIP, 12"			
	665165	R8712D3GCH	Chrome
	666816	R8712D3GBN	Brushed Nickel
	519003	LR8716D3GBN	Brushed Nickel
	519005	LR8716D3GOWB	Old World Bronze

Same as above, but 16"			
	519004	LR8716D3GCH	Chrome
	519003	LR8716D3GBN	Brushed Nickel
	519005	LR8716D3GOWB	Old World Bronze
Same as above, but 24"			
	519014	LR8724D3GCH	Chrome
	519013	LR8724D3GBN	Brushed Nickel
	519015	LR8724D3GOWB	Old World Bronze

Same as above, but 36"			
	600945	LR8736D3GCH	Chrome
	600946	LR8736D3GBN	Brushed Nickel
	650339	LR8736D3GOWB	Old World Bronze
Same as above, but 42"			
	602863	LR8742D3GCH	Chrome
	601020	LR8742D3GBN	Brushed Nickel
	667449	LR8742D3GOWB	Old World Bronze

Same as above, but 48"			
	669838	LR8748D3GCH	Chrome
	669837	LR8748D3GBN	Brushed Nickel
	669839	LR8748D3GOWB	Old World Bronze







ROBE HOOK—EVA			
	519207	YB2803CH	Chrome
	519206	YB2803BN	Brushed Nickel







ROBE HOOK—BRANTFORD			
	567885	YB2203ORB	Oil-Rubbed Bronze

NOTE: For rough-in specifications and other product features, visit the Moen website at www.moen.com

MOEN
ACCESSORIES
(CSI DONNER)



ID	ORDER#	MODEL#	FINISH
			
		SHOWER CHAIR , 22"W x 19.25"D, 18" leg width, 15"-21" adjustable height, non-slip seat	
518874	DN7060		Glacier White
			
		SHOWER CURTAIN RINGS , with decorative balls	
623299	SR2100CH		Chrome
623298	SR2100BN		Brushed Nickel
619724	SR2100OWB		Old World Bronze
			
		SHOWER CURTAIN RINGS	
747126	SR2201BL		Matte Black
			
		SHOWER ROD—5' STRAIGHT ALUMINUM , commercial	
518429	52-5		Chrome
587597	52-5-BN		Brushed Nickel
567770	52-5-OWB		Old World Bronze
			
		SHOWER ROD—5' STRAIGHT SATIN , commercial	
518467	55-5		Stainless
			
		SHOWER ROD—5' CURVED	
698979	CSR2155CH		Chrome
698654	CSR2155BN		Brushed Nickel
697156	CSR2155OWB		Old World Bronze
			
		SHOWER ROD—5'-6' ADJUSTABLE CURVED	
747125	CSR2160BL		Matte Black

ID	ORDER#	MODEL#	FINISH
			
		SHOWER ROD—UP TO 5' ADJUSTABLE DOUBLE CURVED	
655284	DN2141CH		Chrome
655441	DN2141BN		Brushed Nickel
655442	DN2141OWB		Old World Bronze
			
		TANK LEVER—EVA	
519204	YB2801CH		Chrome
519203	YB2801BN		Brushed Nickel
			
		TANK LEVER—BRANTFORD	
567737	YB2201ORB		Oil-Rubbed Bronze
			
		TISSUE HOLDER—BRANTFORD	
566648	YB2208ORB		Oil-Rubbed Bronze
			
		TISSUE HOLDER—EVA	
519210	YB2808CH		Chrome
519209	YB2808BN		Brushed Nickel
			
		TISSUE HOLDER (PIVOTING)—VOSS	
659035	YB5108CH		Brushed Nickel
659034	YB5108BN		Brushed Nickel
			
		TOWEL BAR—BRANTFORD, 18"	
566647	YB2218ORB		Oil-Rubbed Bronze
		Same as above, but 24"	
567892	YB2224ORB		Oil-Rubbed Bronze

NOTE: For rough-in specifications and other product features, visit the Moen website at www.moen.com



ID	ORDER#	MODEL#	FINISH
----	--------	--------	--------



TOWEL BAR—EVA, 18"

519213	YB2818CH	Chrome
519212	YB2818BN	Brushed Nickel

Same as above, but 24"

519216	YB2824CH	Chrome
519215	YB2824BN	Brushed Nickel



TOWEL BAR—VOSS, 24"

659041	YB5124CH	Chrome
659040	YB5124BN	Brushed Nickel



TOWEL RING—BRANTFORD

567895	YB2286ORB	Oil-Rubbed Bronze
--------	-----------	-------------------



TOWEL RING—EVA

519219	YB2886CH	Chrome
519218	YB2886BN	Brushed Nickel



TOWEL RING—VOSS

659047	YB5186CH	Chrome
659046	YB5186BB	Brushed Nickel

NOTE: For rough-in specifications and other product features, visit the Moen website at www.moen.com



ID ORDER#	MODEL#	FINISHED DIMENSIONS (W x D x H)	DESCRIPTION
-----------	--------	---------------------------------	-------------

NOTE: For rough-in specifications and additional product features, visit the Aker website at www.akerbymax.com



141004

1792	141004-R-000-002-002	60" x 33" x 72"	GB-60 TUB/SHOWER—ONE PIECE , white, right hand drain
70363	141004-R-000-007-002	60" x 33" x 72"	Same as above, but biscuit
1793	141004-L-000-002-001	60" x 33" x 72"	Same as above, but left hand drain and white
70362	141004-L-000-007-001	60" x 33" x 72"	Same as above, but biscuit



141393

746662	141396-R-000-002-101	60" x 30" x 73"	6030STT SUBWAY TILE TUB/SHOWER—ONE PIECE , white, right hand drain
746657	141396-L-000-002-100	60" x 30" x 73"	Same as above, but <u>left hand drain</u>
742963	141393-R-000-002-101	60" x 32" x 81"	6032STT SUBWAY TILE TUB/SHOWER—ONE PIECE , white, right hand drain
746659	141393-L-000-002-100	60" x 32" x 81"	Same as above, but left hand drain



142006

762545	142006-R-000-002-095	60" x 32" x 79"	KDTS-3060 TUB/SHOWER—FOUR PIECE UNASSEMBLED , white, right hand drain
762544	142006-L-000-002-094	60" x 32" x 79"	Same as above, but left hand drain
654707	142012-R-000-002-095	60" x 32" x 79"	KDTS-3260 TUB/SHOWER—FOUR PIECE UNASSEMBLED , white, right hand drain
654706	142012-L-000-002-094	60" x 32" x 79"	Same as above, but left hand drain



ID ORDER#	MODEL#	FINISHED DIMENSIONS (W x D x H)	DESCRIPTION
-----------	--------	---------------------------------	-------------

NOTE: For rough-in specifications and additional product features, visit the Aker website at www.akerbymax.com



141021

1810	141021-000-002-000	32" x 32" x 72"	S-32 SHOWER—ONE PIECE , white, no seat, center drain
1816	141022-000-002-000	36" x 36" x 72"	S-36 SHOWER—ONE PIECE , white, no seat, center drain
65612	141022-000-007-000	36" x 36" x 72"	Same as above, but <u>biscuit</u>
45734	141025-000-002-000	42" x 35" x 72"	S-42 SHOWER—ONE PIECE , white, no seat, center drain



141033

231615	141033-R-000-002-002	48" x 36" x 77"	SHRS-48 SHOWER—ONE PIECE , white, right hand seat, center drain
231620	141033-R-000-007-002	48" x 36" x 77"	Same as above, but <u>biscuit</u>
443434	141036-R-000-002-002	60" x 36" x 77"	SHRS-60 SHOWER—ONE PIECE , white, right hand seat, center drain
442397	141036-R-000-007-002	60" x 36" x 77"	Same as above, but <u>biscuit</u>
231608	141033-L-000-002-001	48" x 36" x 77"	SHLS-48 SHOWER—ONE PIECE , white, left hand seat, center drain
231610	141033-L-000-007-001	48" x 36" x 77"	Same as above, but <u>biscuit</u>
443656	141036-L-000-002-001	60" x 36" x 77"	SHLS-60 SHOWER—ONE PIECE , white, left hand seat, center drain
444132	141036-L-000-007-001	60" x 36" x 77"	Same as above, but <u>biscuit</u>



141391

742968	141391-000-002-000	48" x 35" x 81"	14834STT SUBWAY TILE SHOWER—ONE PIECE , white, no seat, center drain
746658	141392-R-000-002-101	60" x 35" x 81"	16034STTS SUBWAY TILE SHOWER—ONE PIECE , white, right hand seat, center drain
746655	141392-L-000-002-100	60" x 35" x 81"	Same as above, but left hand seat



ID ORDER#	MODEL#	FINISHED DIMENSIONS (W x D x H)	DESCRIPTION
-----------	--------	---------------------------------	-------------

NOTE: For rough-in specifications and additional product features, visit the Aker website at www.akerbymax.com



142018

653724	142018-000-002-093	32" x 32" x 76"	KDS-3232 SHOWER—FOUR PIECE UNASSEMBLED , white, no seat, center drain
653747	142024-000-002-093	36" x 36" x 72"	KDS-3636 SHOWER—FOUR PIECE UNASSEMBLED , white, no seat, center drain
653768	142030-000-002-093	48" x 34" x 80"	KDS-3448 SHOWER—FOUR PIECE UNASSEMBLED , white, no seat, center drain
654639	142030-R-000-002-095	48" x 34" x 80"	Same as above, but right hand seat
653777	142030-L-000-002-094	48" x 34" x 80"	Same as above, but left hand seat
654645	142036-000-002-093	60" x 30" x 81"	KDS-3060 SHOWER—FOUR PIECE UNASSEMBLED , white, no seat, center drain
653842	142036-L-000-002-094	60" x 30" x 81"	Same as above, but left hand seat/right drain
654646	142036-R-000-002-095	60" x 30" x 81"	Same as above, but right hand seat/left drain
654646	142036-R-000-007-095	60" x 30" x 81"	Same as above, but biscuit and right hand seat/left drain
654684	142042-000-002-093	60" x 34" x 80"	KDS-3460 SHOWER—FOUR PIECE UNASSEMBLED , white, no seat, center drain
654687	142042-R-000-002-095	60" x 34" x 80"	Same as above, but right hand seat/left drain
654686	142042-L-000-002-094	60" x 34" x 80"	Same as above, but left hand seat/right drain



141038

231409	141038-000-002-000	38" x 38" x 78"	SH-NA NEOANGLE SHOWER—ONE PIECE , white, center drain
231649	14138-000-007-000	38" x 38" x 78"	Same as above, but biscuit
46416	141047-000-002-003	60" x 30" x 81"	KD-NAS NEOANGLE SHOWER—TWO PIECE , white, center drain



ID ORDER#	MODEL#	FINISHED DIMENSIONS (W x D x H)	DESCRIPTION
MAAX COLLECTION SERIES TUBS			
	658330 105744-000-001-100 (#6636)	66" x 36" x 24"	ELLA SLEEK OVAL ACRYLIC FREE-STANDING TUB , white with white skirt
	711592 10034341	--	PVC F2 DRAIN KIT , for #6636 freestanding tub
PROFESSIONAL SERIES BATHTUBS			
	715862 105519-R-000-001 (#6030 IFS)	60" x 30" x 18"	EXHIBIT BATHTUB , white, acrylic finish, discreet armrests, textured floor, integrated tiling flange and skirt, <u>right hand drain</u>
	734427 105519-L-000-001 (#6030 IFS)	60" x 30" x 18"	Same as above, but <u>left hand drain</u>
	712941 105520-R-000-001 (#6032 IFS)	60" x 32" x 18"	EXHIBIT BATHTUB , white, acrylic finish, discreet armrests, textured floor, integrated tiling flange and skirt, <u>right hand drain</u>
	732988 105520-L-000-001 (#6032 IFS)	60" x 32" x 18"	Same as above, but <u>left hand drain</u>
	713055 106172-R-000-001 (#6036 IFS)	60" x 36" x 18"	EXHIBIT BATHTUB , white, acrylic finish, discreet armrests, textured floor, integrated tiling flange and skirt, <u>right hand drain</u>
	713112 106172-L-000-001 (#6036 IFS)	60" x 36" x 18"	Same as above, but <u>left hand drain</u>
	739760 106348-R-000-001 (#6030 IFS)	60" x 30" x 14"	RUBIX ACCESS BATHTUB , white, acrylic finish, Stabili-T anti-slip bottom, low deck height, integrated tiling and skirt, <u>right hand drain</u>
	732894 106348-L-000-001 (#6030 IFS)	60" x 30" x 14"	Same as above, but <u>left hand drain</u>
	743423 105815-R-000-001 (#6030)	60" x 30" x 18"	RUBIX ACCESS BATHTUB , white, acrylic finish, integrated flange and skirt, <u>right hand drain</u>
	715280 105815-L-000-001 (#6030)	60" x 30" x 18"	Same as above, but <u>left hand drain</u>
	684206 105705-R-000-001 (#6032)	60" x 32" x 18"	RUBIX ACCESS BATHTUB , white, acrylic finish, integrated flange and skirt, <u>right hand drain</u>
	739859 105705-L-000-001 (#6032)	60" x 32" x 18"	Same as above, but <u>left hand drain</u>

FOR MORE INFORMATION, VISIT THE MAAX WEBSITE AT www.maax.com

MAAX

TUB/SHOWERS, SHOWERS and SHOWER DOORS



ID ORDER#	MODEL#	FINISHED DIMENSIONS (W x D x H)	DESCRIPTION
--------------	--------	---------------------------------------	-------------

PROFESSIONAL SERIES TUB/SHOWERS



713324	107001-R-000-001 (#TS-6032)	60" x 32" x 79"	ALLIA TUB/SOWER—ONE PIECE , white, acrylic finish, 3-level corner shelves, 12" white grab bar, <u>right hand drain</u>
715314	107001-L-000-001 (#TS-6032)	60" x 32" x 79"	Same as above, but <u>left hand drain</u>

PROFESSIONAL SERIES SHOWERS



732443	107005-000-001 (#SH-4834)	48" x 34" x 79"	ALLIA SHOWER—ONE PIECE , white, acrylic finish, no seat, 3-level corner shelves, 12" white grab bar, textured floor, <u>center drain</u>
746522	107003-NC-000-001 (#SH-6034)	60" x 34" x 79"	Same as above, but <u>60" width</u>

ID ORDER#	MODEL#	FITS OPENING	HEIGHT	DESCRIPTION
--------------	--------	-----------------	--------	-------------

MAAX SERIES SHOWER DOORS



749248	139398-900-340	56-1/2" to 59"	59"	HALO SLIDING TUB DOOR , 8mm clear glass with lotus protection, matte black frame, reversible
--------	----------------	----------------	-----	---

FOR MORE INFORMATION, VISIT THE MAAX WEBSITE AT www.maax.com

BASCO SHOWER DOORS



ID ORDER#	MODEL#	FITS OPENING	HEIGHT	DESCRIPTION	FITS
FRAMED SHOWER DOORS & ENCLOSURES					
731754	100-00701/2RNSV	32-5/8"	70-1/2"	FRAMED DELUXE SINGLE SWING DOOR, 3/16" rain glass, chrome frame	Sterling 72200100
747374	100A-33-63OBSV	32-3/4" to 33-3/4"	63-1/2"	FRAMED DELUXE SINGLE SWING DOOR, CONTINUOUS HINGE, 3/16" obscure glass, chrome frame	Aker S-36
730656	160AKRNSV	--	--	FRAMED DELUXE NEO-ANGLE SWING SHOWER ENCLOSURE, 3/16" rain glass, chrome frame	Aker KD-NAS
730986	160AKARNSV	--	--	FRAMED DELUXE NEO-ANGLE SWING SHOWER ENCLOSURE, 3/16" rain glass, chrome frame	Aker SH-NA
734548	160STRNSV	--	--	FRAMED DELUXE NEO-ANGLE SWING SHOWER ENCLOSURE, 3/16" rain glass, chrome frame, Quick-n-Stall	Sterling 72040100
SEMI-FRAMELESS SHOWER DOORS & ENCLOSURES					
733005	3400-56OBSV	52-1/16" to 56"	57"	SEMI-FRAMELESS CLASSIC BYPASS SLIDING TUB/SHOWER ENCLOSURE, 3/16" obscure glass, chrome frame	--
733962	3400A-60OBSV	56-1/16" to 60"	57"	SEMI-FRAMELESS CLASSIC BYPASS SLIDING TUB/SHOWER ENCLOSURE, 3/16" obscure glass, chrome frame	--
733033	3500-40ENRNSV	--	--	SEMI-FRAMELESS CLASSIC BYPASS SLIDING SHOWER ENCLOSURE, 3/16" rain glass, chrome frame	Sterling 72210100
738530	3500-45ACRNSV	--	--	SEMI-FRAMELESS CLASSIC BYPASS SLIDING SHOWER ENCLOSURE, 3/16" rain glass, chrome frame	Sterling 72280100
730987	3500-45ENRNSV	--	--	Same as above	Sterling 72210100
733617	3500-48RNSV	43" to 47"	70"	SEMI-FRAMELESS CLASSIC BYPASS SLIDING SHOWER ENCLOSURE, 3/16" rain glass, chrome frame	--

FOR MORE INFORMATION, VISIT THE BASCO WEBSITE AT www.bascoshowerdoor.com

FOR ADDITIONAL DOORS, SEE PAGE 205.1







BASCO SHOWER DOORS & ACCESSORIES



ID ORDER#	MODEL#	FITS OPENING	HEIGHT	DESCRIPTION	FITS
SEMI-FRAMELESS SHOWER DOORS & ENCLOSURES					
730657	3500-56ENRNSV	--	--	SEMI-FRAMELESS CLASSIC BYPASS SLIDING SHOWER ENCLOSURE, 3/16" rain glass, chrome frame	Sterling 72170110/120 Sterling 72180110/120 Sterling 72230100
733184	3500-57ACRNSV	--	--	Same as above	Sterling 72290100
727611	3500A-48OBSV	43" to 47"	70"	SEMI-FRAMELESS CLASSIC BYPASS SLIDING SHOWER ENCLOSURE, 3/16" obscure glass, chrome frame	Aker SHRS-48 & SHLS-48
732103	3500A-60OBSV	56-1/16" to 60"	70"	Same as above	Aker SHRS-60 & SHLS-60
734283	3600-28RNSV	28-1/16" to 28-15/16"	70"	SEMI-FRAMELESS CLASSIC SINGLE SWING SHOWER DOOR, 3/16" rain glass, chrome frame	Aker KDS-3232
747952	3600A-32-70OBSV	31-15/16" to 32-13/16"	70"	SEMI-FRAMELESS CLASSIC SINGLE SWING SHOWER DOOR, 3/16" obscure glass, chrome frame	Aker KDS-3636
615432	4500-60RNOR	54-1/2" to 58-1/2"	70"	SEMI-FRAMELESS BYPASS SLIDING SHOWER ENCLOSURE—INFINITY, 1/4" rain glass, oil rubbed bronze frame	--
732638	5500A-60CLBN	56-1/16" to 60"	70"	SEMI-FRAMELESS BYPASS SLIDING SHOWER ENCLOSURE—ROTOLO, 1/4" clear glass, brushed nickel frame	--
ACCESSORIES					
753940	UCP19	--	--	ULTRACLEAR PRO GLASS CLEANER, 19 oz. spray can	--

FOR MORE INFORMATION, VISIT THE BASCO WEBSITE AT www.bascoshowerdoor.com
FOR ADDITIONAL DOORS, SEE PAGE 205.1



	ID ORDER#	MODEL#	OVERALL DIMENSION	DESCRIPTION	COLOR
SELF-RIMMING LAVS					
	566738	249-4	19" x 19"	MAVERICK I LAVATORY , oval, self-rimming 4" CC, concealed front overflow, extra-wide tapered rim, less faucet, drain assembly and supplies, ADA compliant	White
	195799	251-4	19" x 16"	ALTO II LAVATORY , white, oval, self-rimming, 4" CC, concealed front overflow, extra-wide tapered rim, 10-1/4" x 16" basin, less faucet, drain assembly and supplies, ADA compliant	White
	478302	267-4	20" x 17"	MAVERICK II LAVATORY , oval, self-rimming 4" CC, concealed front overflow, extra-wide tapered rim, less faucet, drain assembly and supplies, ADA compliant	White
UNDERMOUNT LAVS					
	693071	218NS-WHT	21-3/8" x 13-1/2"	PETITE COVINGTON LAVATORY , rectangular undermount, includes 4 mounting clips, less drain assembly, ADA compliant	White
WALL-MOUNT LAVS					
	9152	1917C-4	19" x 17"	WILLOW RUN LAVATORY , wall-mount, 4" CC, concealed front overflow, ledge back design, twin soap recesses, includes hanger, less faucet, drain assembly and supplies	White
	144739	2018HBNS-4	22" x 18-1/2"	GRANDE ISLE LAVATORY , wall-mount with 4" high-back backsplash, 4" CC, concealed overflow, 14" x 10" x 5-1/2" basin size, designed for concealed arm installation, includes hanger, less faucet, drain assembly and supplies, ADA compliant	White

FOR MORE INFORMATION, VISIT THE MANSFIELD WEBSITE AT www.mansfieldplumbing.com

MANSFIELD VITREOUS CHINA LAVS





	ID ORDER#	MODEL#	BASIN DIMENSION	DESCRIPTION	COLOR
PEDESTAL LAV COMBINATION					
	657576	330-4	17-5/16" x 11-1/4"	BARRETT PEDESTAL LAVATORY , 4" CC 24-3/8" x 19-1/8" x 34" overall dimension, with rear overflow	White
	657679	330-8	17-5/16" x 11-1/4"	<i>Same as above</i> , but with 8" CC	White

FOR MORE INFORMATION, VISIT THE MANSFIELD WEBSITE AT www.mansfieldplumbing.com

MANSFIELD

ELONGATED TOILETS — LINED







	ID ORDER#	MODEL#	ROUGH-IN DIMENSION	DESCRIPTION	COLOR
	62301	135-170	12"	ALTO ELONGATED TOILET, with tank liner, 2-piece, glazed trapway, 1.6 gpf, large water surface area, SmartFlush siphon jet, gravity-fed flushing action, includes tank trim and chrome-plated plastic trip lever, meets ANSI/ASME A112.19.2M-1998 code, less toilet seat and supply	White
	62302	135-170	12"	<i>Same as above</i>	Bone
	76988	135-170	12"	<i>Same as above</i>	Biscuit
	72991	137-170	12"	ALTO SMARTHEIGHT ELONGATED TOILET, with tank liner, 2-piece, 16-7/8" bowl height, glazed trapway, 1.6 gpf, large water surface area, SmartFlush siphon jet, gravity-fed flushing action, includes tank trim and chrome-plated plastic trip lever, ADA compliant, less toilet seat and supply	White
	72992	137-170	12"	<i>Same as above</i>	Bone
	587070	137-170	12"	<i>Same as above</i>	Biscuit
	684807	384-386LT	12"	SUMMIT SMARTHEIGHT ELONGATED TOILET, with tank liner, 2-piece, 16-7/8" bowl height, 1.6 gpf, pilot operated anti-siphon fill valve, Magna-Flush high performance flushing technology with 3" flush valve, chrome-plated metal trip lever, ADA compliant, less toilet seat and supply	White

FOR MORE INFORMATION, VISIT THE MANSFIELD WEBSITE AT www.mansfieldplumbing.com

MANSFIELD

ELONGATED TOILETS — UNLINED





	ID ORDER#	MODEL#	ROUGH-IN DIMENSION	DESCRIPTION	COLOR
	62317	135-160	12"	ALTO ELONGATED TOILET, without tank liner , 2-piece, glazed trapway, 1.6 gpf, large water surface area, SmartFlush siphon jet, gravity-fed flushing action, includes tank trim and chrome-plated plastic trip lever, meets ANSI/ASME A112.19.2M-1998 code, less toilet seat and supply	White
	62318	135-160	12"	<i>Same as above</i>	Bone
	76992	135-160	12"	<i>Same as above</i>	Biscuit
	654996	135-160RH	12"	<i>Same as above</i> , but <u>with right hand trip lever</u>	White
	72993	137-160	12"	ALTO SMARTHEIGHT ELONGATED TOILET, without tank liner , 2-piece, 16-7/8" bowl height, glazed trapway, 1.6 gpf, large water surface area, SmartFlush siphon jet, gravity-fed flushing action, includes tank trim and chrome-plated plastic trip lever, ADA compliant, less toilet seat and supply	White
	72995	137-160	12"	<i>Same as above</i>	Bone
	587068	137-160	12"	<i>Same as above</i>	Biscuit
	654997	137-160RH	12"	<i>Same as above</i> , but <u>with right hand trip lever</u>	White
	213873	135-125	14"	ALTO ELONGATED TOILET, without tank liner , 2-piece, glazed trapway, 1.6 gpf, large water surface area, SmartFlush siphon jet, gravity-fed flushing action, includes tank trim and chrome-plated plastic trip lever, meets ANSI/ASME A112.19.2M-1998 code, less toilet seat and supply	White
	213874	137-125	14"	ALTO SMARTHEIGHT ELONGATED TOILET, without tank liner , 2-piece, 16-7/8" bowl height, glazed trapway, 1.6 gpf, large water surface area, SmartFlush siphon jet, gravity-fed flushing action, includes tank trim and chrome-plated plastic trip lever, ADA compliant, less toilet seat and supply	White
	657549	4115-106	12"	BARRETT SMARTHEIGHT ELONGATED TOILET, without tank liner , 2-piece, 16-1/4" bowl height, 1.6 gpf, concealed trapway, pilot operated anti-siphon fill valve, MagnaFlush high performance flushing technology with 3" flush valve, chrome metal trip lever, ADA compliant, less toilet seat and supply	White
	657559	4115-106	12"	<i>Same as above</i>	Biscuit

FOR MORE INFORMATION, VISIT THE MANSFIELD WEBSITE AT www.mansfieldplumbing.com

MANSFIELD

ELONGATED TOILETS — UNLINED





	ID ORDER#	MODEL#	ROUGH-IN DIMENSION	DESCRIPTION	COLOR
	714674	382-386	--	SUMMIT ELONGATED TOILET , <u>without tank liner</u> , 2-piece, glazed trapway, 1.6 gpf, pilot operated anti-siphon fill valve, MagnaFlush high performance flushing technology with 3" flush valve, chrome-plated metal trip lever, meets ASME A112.19.2/ CSA B45.1 code, less toilet seat and supply	White
	727620	382-386	12"	Same as above	Biscuit
	734545	382-386	12"	Same as above, but <u>with right hand trip lever</u>	White
	774449	382-376	12"	Same as above, but <u>with right hand, white metal trip lever</u>	White
	655528	384-386	12"	SUMMIT SMARTHEIGHT ELONGATED TOILET , <u>without tank liner</u> , 2-piece, 16-7/8" bowl height, 1.6 gpf, pilot operated anti-siphon fill valve, MagnaFlush high performance flushing technology with 3" flush valve, chrome-plated metal trip lever, ADA compliant, less toilet seat and supply	White
	657564	384-386	12"	Same as above	Bone
	657544	384-386	12"	Same as above	Biscuit
	668849	384-386RH	12"	Same as above, but <u>with right hand trip lever</u>	White
	774448	384-376	12"	Same as above, but <u>with right hand, white metal trip lever</u>	White
	666760	384-3386	12"	SUMMIT SMARTHEIGHT DUAL-FLUSH ELONGATED TOILET , <u>without tank liner</u> , 2-piece, 16-7/8" bowl height, 1.1/1.6 gpf, pilot operated anti-siphon fill valve, Dual Flush flushing technology with 3" flush valve, chrome push button actuator, ADA compliant, less toilet seat and supply	White
	666826	384-3386	12"	Same as above	Bone

FOR MORE INFORMATION, VISIT THE MANSFIELD WEBSITE AT www.mansfieldplumbing.com

MANSFIELD ROUND TOILETS — LINED



	ID ORDER#	MODEL#	ROUGH-IN DIMENSION	DESCRIPTION	COLOR
	62295	130-170	12"	ALTO ROUND TOILET , with tank liner, 2-piece, glazed trapway, 1.6 gpf, large water surface area, SmartFlush siphon jet, gravity-fed flushing action, includes tank trim and chrome-plated plastic trip lever, less toilet seat and supply	White
	62296	130-170	12"	Same as above	Bone
	76985	130-170	12"	Same as above	Biscuit
	62853	130-174	12"	Same as above, but with bone trip lever	Bone
					WHILE SUPPLIES LAST
	62298	131-170	10"	ALTO ROUND TOILET , with tank liner, 2-piece, glazed trapway, 1.6 gpf, large water surface area, SmartFlush siphon jet, gravity-fed flushing action, includes tank trim and chrome-plated plastic trip lever, meets ANSI/ASME A112.19.6-1995 and A112.19.2M-1998 code, less toilet seat and supply	White
	62299	131-170	10"	Same as above	Bone
					WHILE SUPPLIES LAST
	478205	117-170	12"	ALTO SMARTHEIGHT ROUND TOILET , with tank liner, 2-piece, glazed trapway, 1.6 gpf, SmartFlush siphon jet, gravity-fed flushing action, includes tank trim and chrome-plated plastic trip lever, ADA compliant, less toilet seat and supply	White
	635003	117-170	12"	Same as above	Biscuit
	684821	380-386LT	12"	SUMMIT ROUND TOILET , with tank liner, 2-piece, 1.6 gpf, pilot operated anti-siphon fill valve, MagnaFlush high performance flushing technology with 3" flush valve, chrome-plated metal trip lever, less toilet seat and supply	White
	684818	380-386LT	12"	Same as above	Biscuit
	684812	388-386LT	12"	SUMMIT SMARTHEIGHT ROUND TOILET , with tank liner, 2-piece, 1.6 gpf, pilot operated anti-siphon fill valve, MagnaFlush high performance flushing technology with 3" flush valve, chrome-plated metal trip lever, ADA compliant, less toilet seat and supply	White
	684811	388-386LT	12"	Same as above	Bone
	684809	388-386LT	12"	Same as above	Biscuit

FOR MORE INFORMATION, VISIT THE MANSFIELD WEBSITE AT www.mansfieldplumbing.com

MANSFIELD

ROUND TOILETS — UNLINED



	ID ORDER#	MODEL#	ROUGH-IN DIMENSION	DESCRIPTION	COLOR
	62311	130-160	12"	ALTO ROUND TOILET , <u>without tank liner</u> , 2-piece, glazed trapway, 1.6 gpf, large water surface area, SmartFlush siphon jet, gravity-fed flushing action, includes tank trim and chrome-plated plastic trip lever, less toilet seat and supply	White
	62312	130-160	12"	<i>Same as above</i>	Bone
	76989	130-160	12"	<i>Same as above</i>	Biscuit
	654995	130-160RH	12"	<i>Same as above</i> , but <u>with right hand trip lever</u>	White
	62314	131-160	10"	ALTO ROUND TOILET , <u>without tank liner</u> , 2-piece, glazed trapway, 1.6 gpf, large water surface area, SmartFlush siphon jet, gravity-fed flushing action, includes tank trim and chrome-plated plastic trip lever, meets ANSI/ASME A112.19.6-1995 and A112.19.2M-1998 code, less toilet seat and supply	White
	62315	131-160	10"	<i>Same as above</i> WHILE SUPPLIES LAST	Bone
	655009	131-160RH	10"	<i>Same as above</i> , but <u>with right hand trip lever</u>	White
	213872	130-125	14"	ALTO ROUND TOILET , <u>without tank liner</u> , 2-piece, glazed trapway, 1.6 gpf, large water surface area, SmartFlush siphon jet, gravity-fed flushing action, includes tank trim and chrome-plated plastic trip lever, less toilet seat and supply	White
	699060	117-125	14"	ALTO SMARHEIGHT ROUND TOILET , <u>without tank liner</u> , 2-piece, glazed trapway, 1.6 gpf, Smart-Flush siphon jet, gravity-fed flushing action, includes tank trim and chrome-plated plastic trip lever, ADA compliant, less toilet seat and supply	White
	577665	117-160	12"	ALTO SMARHEIGHT ROUND TOILET , <u>without tank liner</u> , 2-piece, glazed trapway, 1.6 gpf, Smart-Flush siphon jet, gravity-fed flushing action, includes tank trim and chrome-plated plastic trip lever, ADA compliant, less toilet seat and supply	White
	635004	117-160	12"	<i>Same as above</i>	Biscuit
	654998	117-160RH	12"	<i>Same as above</i> , but <u>with right hand trip lever</u>	White





FOR MORE INFORMATION, VISIT THE MANSFIELD WEBSITE AT www.mansfieldplumbing.com

MANSFIELD

ROUND TOILETS — UNLINED

and URINALS



	ID ORDER#	MODEL#	ROUGH-IN DIMENSION	DESCRIPTION	COLOR
	615970	380-386	12"	SUMMIT ROUND TOILET , <u>without tank liner</u> , 2-piece, 1.6 gpf, pilot operated anti-siphon fill valve, MagnaFlush high performance flushing technology with 3" flush valve, chrome trip lever, less toilet seat and supply	White
	658577	380-386	12"	<i>Same as above</i>	Biscuit
	734544	380-386RH	12"	<i>Same as above</i> , but <u>with right hand trip lever</u>	White
	774451	380-376	12"	<i>Same as above</i> , but <u>with right hand, white metal trip lever</u>	White
	666830	380-3386	12"	SUMMIT DUAL-FLUSH ROUND TOILET , <u>without tank liner</u> , 2-piece, 1.1/1.6 gpf, pilot operated anti-siphon fill valve, Dual Flush flushing technology with 3" flush valve, chrome push button actuator, less toilet seat and supply	White
	666828	380-3386	12"	<i>Same as above</i>	Biscuit
	680102	388-386	12"	SUMMIT SMARTHEIGHT ROUND TOILET , <u>without tank liner</u> , 2-piece, 1.6 gpf, pilot operated anti-siphon fill valve, MagnaFlush high performance flushing technology with 3" flush valve, chrome metal trip lever, ADA compliant, less toilet seat and supply	White
	680109	388-386	12"	<i>Same as above</i>	Bone
	680108	388-386	12"	<i>Same as above</i>	Biscuit
	680113	388-386RH	12"	<i>Same as above</i> , but <u>with right hand trip lever</u>	White
	774447	388-376	12"	<i>Same as above</i> , but <u>with right hand, white metal trip lever</u>	White
	680112	388-3386	12"	SUMMIT SMARTHEIGHT DUAL-FLUSH ROUND TOILET , <u>without tank liner</u> , 2-piece, 1.1/1.6 gpf, pilot operated anti-siphon fill valve, Dual Flush flushing technology with 3" flush valve, chrome push button actuator, ADA compliant, less toilet seat and supply	White
URINALS					
	694444	401HE	--	ADAM WALL-MOUNT/WASH DOWN URINAL , 0.5 gpf, rim-flushing action, exposed trap, concealed hanger and bolts, 13-5/8" x 19-1/2" x 13-1/4" overall dimensions, fitted with 3/4" top spud and 1-1/2" outlet spud, includes mounting bracket, less flush valve, meets ANSI/ASME A112.19.2M-1998 code	White



WHILE
SUPPLIES
LAST

WHILE
SUPPLIES
LAST

ID ORDER#	MODEL#	DESCRIPTION
69516	47CH	ACTUATOR—PUSHBUTTON
62992	08-10	BALLCOCK , 10", anti-siphon, plastic, for use in 3.5 gpf toilets, code approved
15023	08-1112	Same as above, but 11-1/2"
53474	BCWHT	CLOSET BOLT CAP , pair, with clips, white
53475	BCBONE	Same as above, but bone
195814	BCBISC	Same as above, but biscuit
657597	630-0207	FLAPPER REPLACEMENT KIT , universal, fits all Mansfield 3" flapper flush valves
41384	630-6005	FLOAT BALL , flue, polyethylene, high buoyancy "tank float"
667018	308	FLUSH VALVE—DUAL , for #3386 tank
726315	2037-1212	FLUSH VALVE—LARGE SIZE , for 1.6 gpf Summit #386 tank
15024	210-1112	FLUSH VALVE—PLASTIC , 11-1/2" length, for use in 3.5 gpf toilets (#11, #21, #26, #35 and #51 tanks), includes shank gasket and locknut, accommodates all trip levers
61946	211-1112	Same as above, but for use in 1.6 gpf toilets (tank Models 125, 159, 160, 161, 165, 170, 175, 180, 181 and 190)
29202	630-4837	FLUSH VALVE SEAL , for #208 and #209 flush valves
28627	630-0030	Same as above, but for #210 and #211 flush valves
25006	471-3261	HANGER—LAV/URINAL , 1-piece, metal, for #401 and #475 urinals
76135	660-3718	PLUNGER , for #08 and #88 ballcocks
76137	123-7838	SERVICE KIT—BALLCOCK CAP AND LEVER , for #08 and #88 ballcocks, includes (1) cap and lever assembly and (1) plunger
15025	630-7984	SERVICE KIT—BALLCOCK , for #08 ballcock, includes (1) upper and (1) lower diaphragm
684775	630-0107	SERVICE KIT—TANK-TO-BOWL "SMARTFASTEN," includes tank-to-bowl gasket, (3) bolts, (3) nuts and ballcock coupling nut

FOR MORE INFORMATION, VISIT THE MANSFIELD WEBSITE AT www.mansfieldplumbing.com

PRIER

FLUSH VALVES & REPAIR PARTS









ID ORDER#	MODEL#	DESCRIPTION
FLUSH VALVES		
	26949	190-0
		URINAL FLUSH VALVE , straight pattern, 0.25 gpf, 1/2" FIP inlet x 3/8" FIP outlet, includes (1) 6" chrome tail piece, (1) 3/4" spud connector nut, (1) friction ring, (1) rubber washer and (1) white spud cover
PARTS		
1607	630-5043	SERVICE KIT—URINAL VALVE REPAIR CARTRIDGE , for #190-0 and #195-0, includes (1) push button assembly, complete with dash pot
123991	630-5702	SERVICE KIT—BALLCOCK , for #07, includes (1) nylon plunger, (1) upper and lower diaphragm, (1) brass thumb screw and (4) brass body screws
22227	630-0040	TIMER CARTRIDGE KIT , for #1075, includes (1) timer cartridge assembly, (1) O-ring, (1) push button retainer and (1) push button screw
22226	630-0042	URINAL REPAIR KIT , for #1075 and #1150, includes (1) valve body diaphragm, (1) vacuum breaker diaphragm, (1) flow control check valve O-ring, (1) control pin spring and (1) control pin and washer

FOR ADDITIONAL INFORMATION, VISIT THE PRIER WEBSITE AT www.prier.com

BEMIS TOILET SEATS



	ID ORDER#	MODEL#	DESCRIPTION
ELONGATED TOILET SEATS			
	734002	1200E4-000	AFFINITY ELONGATED CLOSED FRONT WITH COVER—WHITE , plastic, WhisperClose hinge, EasyClean and Change and Super Grip Bumpers
	734003	1200E4B-006	<i>Same as above</i> , but bone
	773741	1200E4B-346	<i>Same as above</i> , but biscuit
	743569	1600E4-000	ASHLAND ELONGATED CLOSED FRONT WITH COVER—WHITE , enameled wood, with E4 hinge system, STA-TITE seat fastening system, Precision Seat Fit adjustable plastic hinge, WhisperClose, EasyClean
	743570	1600E4-346	<i>Same as above</i> , but biscuit
	615992	170-000	ELONGATED CLOSED FRONT WITH COVER—WHITE , plastic, basic Top-Tite hinges
	466170	2L2155T-000	ELONGATED LIFT-TYPE OPEN FRONT LESS COVER—HEAVY-DUTY—WHITE , plastic, includes 2" lifts, STA-TITE seat fastening system and Super Grip Bumpers
ROUND TOILET SEATS			
	743577	600E4-000	ASHLAND ROUND CLOSED FRONT WITH COVER—WHITE , enameled wood, with E4 hinge system, STA-TITE seat fastening system, Precision Seat Fit adjustable plastic hinge, WhisperClose, EasyClean
	615988	70-000	ROUND CLOSED FRONT WITH COVER—WHITE , plastic, with basic top-tite hinges
	698850	955SSCT-000	ROUND OPEN FRONT LESS COVER—HEAVY-DUTY—WHITE , plastic, self-sustaining check hinge, STAY-TITE seat fastening system

FOR MORE INFORMATION, VISIT THE BEMIS WEBSITE AT www.toiletseats.com

ELKAY WATER COOLERS & ACCESSORIES







ID ORDER#	MODEL#	OVERALL SIZE (L x W x BOWL DEPTH)	HOLES	DESCRIPTION
 209617	EZS8L	18-3/8" x 19" x 19-13/16"		WATER COOLER , wall-hung, ADA, non-filtered, 8.0 gph chilling capacity, vinyl light gray "granite" cabinet with stainless steel basin, Easy Touch controls on front and both sides and Flexi-Guard safety bubbler
 217517	EZSTL8LC	36-7/8" x 19" x 25-5/16"		WATER COOLER—TWO-STATION , wall-hung, bi-level ADA, non-filtered, 8.0 gph chilling capacity, vinyl light gray "granite" cabinet with stainless steel basin, Easy Touch controls on front and both sides
 699412	LZS8WSP	18-3/8" x 19" x 39-7/16"		WATER COOLER WITH BOTTLE FILLING STATION—SINGLE LEVEL , wall-hung, ADA, filtered, 8.0 gph chilling capacity, vinyl light gray "granite" cabinet, antimicrobial, hands free, laminar flow
 699413	LZSTL8WSP	36-3/4" x 19" x 39-1/2"		WATER COOLER—TWO STATION—WITH BOTTLE FILLING STATION , wall-hung, bi-level ADA, filtered, 8.0 gph chilling capacity, vinyl light gray "granite" cabinet, antimicrobial, hands free, laminar flow
 691370	EZWSRK	17-7/8" x 18-7/8" x 3-9/16"		RETROFIT BOTTLE FILLING STATION , wall-hung, non-refrigerated, non-filtered, fits 115V pushbar-activated EZ style water coolers, antimicrobial, hands free, laminar flow
ACCESSORIES				
 17670	LK142	2-3/8" x 1-7/16" x 4-3/4"		BUBBLER , for EDF-15AC, push button, self-cleaning with pressure regulated removable cartridge, requires 3/4" diameter mounting hole and 3/8" IP connection, chrome-plated brass
 700159	51300C	--		WATERCENTRY PLUS REPLACEMENT FILTER , for EZH2O bottle filling stations
 772038	51300C_12PK	--		Same as above, but pack of 12
 1749	61313C	--		WATER PRESSURE REGULATOR , for LK-142 bubbler
66105	61314C	--		Same as above, but for handicap coolers

ELKAY

STAINLESS STEEL KITCHEN SINKS







ID ORDER#	MODEL#	OVERALL SIZE (L x W x BOWL DEPTH)	HOLES	DESCRIPTION	
DROP-IN KITCHEN SINKS					
	1657	CR25214	25" x 21-1/4" x 6-7/8"	4	CELEBRITY DROP-IN—SINGLE BOWL , 20 gauge, Type 304 stainless steel
	1666	CR33214	33" x 21-1/4" x 6-7/8"	4	CELEBRITY DROP-IN—DOUBLE EQUAL BOWLS , 20 gauge, Type 304 stainless steel
	1676	PSR33224	33" x 22" x 7-1/2"	4	CELEBRITY DROP-IN—DOUBLE EQUAL BOWLS , 20 gauge, Type 304 stainless steel
UNDERMOUNT KITCHEN SINKS					
	646616	ELUHAQD3218	32-1/16" x 18-1/2" x 8" 4-5/8" aqua divide	--	LUSTERTONE CLASSIC UNDER-MOUNT—DOUBLE EQUAL BOWLS WITH AQUA DIVIDE , 18 gauge, Type 304 stainless

FOR MORE INFORMATION, VISIT THE ELKAY WEBSITE AT www.elkay.com

ELKAY

STAINLESS STEEL BAR SINKS & ACCESSORIES



	ID ORDER#	MODEL#	OVERALL SIZE (L x W x BOWL DEPTH)	HOLES	DESCRIPTION
BAR SINKS					
	198656	BCR152	15" x 15" x 6-1/8"	2	CELEBRITY DROP-IN BAR SINK—SINGLE BOWL , ADA compliant, 20 gauge, Type 304 stainless steel
ACCESSORIES					
	551517	LKWOBG1316SS	12-1/2" x 15" x 1"	--	BOTTOM GRID—WAVY WIRE , stainless steel, corrosion resistant, dishwasher safe
	551488	LKQD35BK	4-1/2" x 4-1/2" x 2-1/8"	--	DISPOSAL FLANGE—POLYMER , with removable basket strainer and rubber stopper, <u>black</u> color, for garbage disposals that accommodate 4-1/2" flange or select InSinkErator disposers
	723240	LKQS35BK	4-1/2" x 4-1/2" x 3"	--	BASKET STRAINER—POLYMER , with removable basket strainer and rubber stopper, <u>black</u> color, for sinks with a 3-1/2" drain opening

FOR MORE INFORMATION, VISIT THE ELKAY WEBSITE AT www.elkay.com

ELKAY

QUARTZ KITCHEN & LAUNDRY SINKS









ID ORDER#	MODEL#	OVERALL SIZE (L x W x BOWL DEPTH)	HOLES	DESCRIPTION	
DROP-IN KITCHEN SINKS					
** WHILE SUPPLIES LAST					
	601355	ELG3322BK0	33" x 22" x 9-1/2"	--	QUARTZ CLASSIC DROP-IN—DOUBLE EQUAL BOWLS , <u>black</u> color
	601357	ELG3322WH0	33" x 22" x 9-1/2"	--	Same as above, but <u>white</u> color
	623682 **	ELGLB3322BQ0	33" x 22" x 9-1/2" 4" aqua divide	--	QUARTZ CLASSIC DROP-IN—DOUBLE EQUAL BOWLS WITH AQUA DIVIDE , <u>bisque</u> color
	625878 **	ELGLB3322WH0	33" x 22" x 9-1/2"	--	Same as above, but <u>white</u> color
UNDERMOUNT KITCHEN SINKS					
	601361	ELGU250RBK0	33" x 20-1/2" x 9-1/2" LH well: 14-1/8" x 18-3/16" RH well: 14-1/8" x 16-3/16"	--	QUARTZ CLASSIC UNDERMOUNT—OFFSET DOUBLE BOWLS , <u>black</u> color
	619688 **	ELGU250RMC0	33" x 22" x 9-1/2"	--	Same as above, but <u>mocha</u> color
	601369	ELGU3322WH0	33" x 18-3/4" x 9-1/2"	--	QUARTZ CLASSIC UNDERMOUNT—DOUBLE EQUAL BOWLS , <u>white</u> color
	619682 **	ELGULB3322BK0	33" x 20" x 9-1/2" 4" aqua divide	--	QUARTZ CLASSIC UNDERMOUNT—DOUBLE EQUAL BOWLS WITH AQUA DIVIDE , <u>black</u> color
	619649 **	ELGULB3322MC0	33" x 9-1/2" x 20-1/8"	--	Same as above, but <u>mocha</u> color
LAUNDRY SINKS					
	732096	ELGU251912PDWH0	25" x 18-1/2" x 11-13/16"	--	QUARTZ CLASSIC UNDERMOUNT LAUNDRY SINK , with perfect drain, <u>white</u> color
QUARTZ SINK ACCESSORIES					
	711927	LKEG250	--	--	QUARTZ REJUVENATOR , 8 oz.

FOR MORE INFORMATION, VISIT THE ELKAY WEBSITE AT www.elkay.com

DAYTON

STAINLESS STEEL KITCHEN SINKS







	ID ORDER#	MODEL#	OVERALL SIZE (L x W x BOWL DEPTH)	HOLES	DESCRIPTION
DROP-IN KITCHEN SINKS					
	548719	DSE125221	25" x 22" x 8-1/16"	1	DAYTON DROP-IN—SINGLE BOWL, BOWLS , 20 gauge, 300 series stainless steel
	548722	DSE125224	25" x 22" x 8-1/16"	4	<i>Same as above</i>
	733785	DSE133221	33" x 22" x 8-1/16"	1	DAYTON DROP-IN—SINGLE BOWL, BOWLS , 20 gauge, 300 series stainless steel
	733786	DSE133224	33" x 22" x 8-1/16"	4	<i>Same as above</i>
	548727	DSE233221	33" x 22" x 8-1/16"	1	DAYTON DROP-IN—DOUBLE EQUAL BOWLS , 20 gauge, 300 series stainless steel
	548622	D233224	33" x 22" x 6-9/16"	4	DAYTON DROP-IN—DOUBLE EQUAL BOWLS , 22 gauge, 300 series stainless steel
	548658	DD233221	33" x 22" x 7-1/16"	1	DAYTON DROP-IN—DOUBLE EQUAL BOWLS , 22 gauge, 300 series stainless steel
	548660	DD233224	33" x 22" x 7-1/16"	4	<i>Same as above</i>
	672200	DXR250R1	33" x 22" x 8-3/16" LH well: 13-1/2" x 18" RH well: 14" x 15-3/4"	1	DAYTON DROP-IN—OFFSET DOUBLE BOWLS , 18 gauge, 300 series stainless steel

FOR MORE INFORMATION, VISIT THE ELKAY WEBSITE AT www.elkay.com

DAYTON STAINLESS STEEL SINKS









	ID ORDER#	MODEL#	OVERALL SIZE (L x W x BOWL DEPTH)	HOLES	DESCRIPTION
UNDERMOUNT SINKS					
	548759	DXUH2115	23-1/2" x 18-1/4" x 8"	--	DAYTON UNDERMOUNT—SINGLE BOWL , 18 gauge, 300 series stainless steel
	548761	DXUH2816	30-1/2" x 18-1/4" x 8"	--	<i>Same as above</i>
	548762	DXUH3118	31-3/4" x 18-1/4" x 8"	--	DAYTON UNDERMOUNT—EQUAL DOUBLE BOWLS , 18 gauge, 300 series stainless steel
BAR/PREP SINKS					
	548593	D115161	15" x 15" x 5-3/16"	1	DAYTON DROP-IN BAR SINK , 23 gauge, 300 series stainless steel, ADA compliant
	548594	D115162	15" x 15" x 5-3/16"	2	<i>Same as above</i>
ACCESSORIES					
	668727	GBG1415SS	12-7/16" x 10-11/16" x 1"		BOTTOM GRID—STAINLESS STEEL , corrosion resistant, dishwasher safe, for bowls with center drain opening, for DXUH3118

FOR MORE INFORMATION, VISIT THE ELKAY WEBSITE AT www.elkay.com

MUSTEE





SHOWER STALLS & LAUNDRY SINKS

	ID ORDER#	MODEL#	SIZE (L x W x D)	DESCRIPTION
SHOWER STALLS				
	89861	80	32" x 32" x 75-3/8"	DURASTALL PREMIER SHOWER STALL , white, high-gloss thermoplastic walls, molded top frame, rigid aluminum front supports, slip-resistant base, one-piece wrap-around railing with built-in soap dish and container, skid-resistant floor with drain assembly, shower valve and head, shower curtain and rod, and assembly hardware
HOBBY/LAUNDRY/MOP SINKS				
	120747	11	20" x 17" x 10"	HOBBY SINK—DROP-IN , white, self-rimming, 8 gallon capacity, 3-1/2" reinforced drain opening fits standard basket drain assembly (not included), connects to standard 1-1/2" P or S trap, stain resistant, semi-gloss
	89414	10 (t)	22" x 25" x 13-3/4"	LAUNDRY SINK—DROP-IN , white, self-rimming, 17 gallon capacity, 1-1/2" drain assembly with stopper, reinforced drain opening fits standard basket drain assembly (not included), connects to standard 1-1/2" P or S trap, stain resistant, semi-gloss
	18820	10C	22" x 25" x 13-3/4"	<i>Same as above</i> , but with 3-1/2" reinforced drain opening that fits standard basket drain assembly (not included)
	89418	63M	24" x 24" x 10"	MOP BASIN , marbleized white, Durastone (combination fiberglass and crushed stone with smooth surface), elevated self-draining shelf and removable strainer, integral molded-in drain for connection to 3" ABS, PVC (Schedule 80) or iron pipe; drain seals for connection to 2" pipe or 3" soil pipe
	89856	65M	24" x 36" x 10"	<i>Same as above</i>
	737823	2218	22" x 18" x 10"	UTILITY SINK—UNDERMOUNT , white, Varistone, fiberglass, 12 gallon capacity, 3-1/2" drain assembly, semi-gloss
LAUNDRY TUBS				
	89402	14	23-1/2" x 18" x 15"	LAUNDRY TUB COMBO , white, 20 gallon capacity, includes 6" swing end faucet with areator and hose end, (2) 20" flexible supply lines and sealant tape, 1-1/2" PVC P-trap with 12" tailpiece, drain stopper, leakproof integrally molded-in drain with stopper, finished steel legs with adjustable levelers, connects to standard 1-1/2" P or S trap

FOR MORE INFORMATION, VISIT THE MUSTEE WEBSITE AT www.mustee.com

(t) There is no warranty if used with a Shellback pump.

MUSTEE LAUNDRY TUBS & ACCESSORIES

ID ORDER#	MODEL#	SIZE (D x W x H)	DESCRIPTION	
LAUNDRY TUBS				
	89405	18F (†)	24" x 20" x 14-3/8"	LAUNDRY TUB—FLOORMOUNT , white, 18 gallon capacity, Durastone (combination fiberglass and crushed stone with smooth surface), includes leakproof integrally molded-in drain with stopper, heavy-gauge steel legs with adjustable levers, connects to standard 1-1/2" P or S trap, self-draining back shelf with retainer curb
	89406	18W (†)	24" x 20" x 14-3/8"	LAUNDRY TUB—WALLMOUNT , white, 18 gallon capacity, Durastone (combination fiberglass and crushed stone with smooth surface), includes leakproof integrally molded-in drain with stopper, wall mounting bracket, side supports, mounting hardware, connects to standard 1-1/2" P or S trap, self-draining back shelf with retainer curb
	89407	26F (†)	24" x 40" x 14-3/8"	DOUBLE LAUNDRY TUB—FLOORMOUNT , white, 19 gallon capacity per tub, Durastone (combination fiberglass and crushed stone with smooth surface), includes twin-drain waste connector with washers, slip nuts and stoppers, divider wall recessed 1", heavy-gauge steel legs with adjustable levers, connects to standard 1-1/2" P or S trap, self-draining back shelf with retainer curb
	89408	26W (†)	24" x 40" x 14-3/8"	DOUBLE LAUNDRY TUB—WALLMOUNT , white, 19 gallon capacity per tub, Durastone (combination fiberglass and crushed stone with smooth surface), includes twin-drain waste connector with washers, slip nuts and stoppers, divider wall recessed 1", wall-mounting bracket, side supports and mounting hardware, connects to standard 1-1/2" P or S trap, self-draining back shelf with retainer curb
ACCESSORIES				
	89421	63.401	--	BUMPER GUARD—PVC , white
	136529	65.308	--	DRAIN SEAL , 2"
	141133	20.600	--	FAUCET BLOCK , for 15W, 18W and 19W
	89419	65.700	--	HOSE & BRACKET , stainless steel
	89420	65.600	--	MOP HANGER , stainless steel

FOR MORE INFORMATION, VISIT THE MUSTEE WEBSITE AT www.mustee.com

(†) There is no warranty if used with a Shellback pump.



ID ORDER#	MODEL#	DESCRIPTION
-----------	--------	-------------

ADVANCED PRO SERIES DISPOSERS



777725	PRO-750 (79850K-ISE)	GARBAGE DISPOSER , 3/4 HP, EZ Connect 3-stage <u>with power cord</u> , auto-reverse, anti-microbial baffle, 12-1/4" overall height, 10 year in-home warranty
--------	-------------------------	---



777728	PRO-1000 (79852K-ISE)	GARBAGE DISPOSER , 1 HP, EZ Connect 4-stage <u>with power cord</u> , auto-reverse, anti-microbial baffle, 12-1/4" overall height, 11 year in-home warranty
--------	--------------------------	---



774491	PRO-1250 (79853K-ISE)	GARBAGE DISPOSER , 1.25 HP, EZ Connect 4-stage <u>with power cord</u> , auto-reverse, anti-microbial baffle, 12-1/4" overall height, 12 year in-home warranty
--------	--------------------------	--

CONTRACTOR SERIES DISPOSERS



777730	Contractor 333 (79848K-ISE)	HEAVY-DUTY DISPOSER , 3/4 HP, EZ Connect <u>with power cord</u> , stainless steel grind components, polished stainless steel flange with 1-piece stainless steel stopper, Quick Lock mounting, 12" overall height, 7 year in-home warranty
--------	--------------------------------	---



777732	Contractor 1000 (79849K-ISE)	HEAVY-DUTY DISPOSER , 1 HP, EZ Connect <u>with power cord</u> , stainless steel grind components, polished stainless steel flange with 1-piece stainless steel stopper, Quick Lock mounting, 12" overall height, 8 year in-home warranty
--------	---------------------------------	---

BADGER SERIES DISPOSERS



732895	Badger 5 (79883-ISE)	GARBAGE DISPOSER , 1/2 HP, 2 stage, galvanized steel construction, <u>less power cord</u> , Quick Lock sink mount, 11-1/2" overall height, 3 year in-home warranty
--------	-------------------------	---



641782	Badger 5XP (79326-ISE)	GARBAGE DISPOSER , 3/4 HP, 2 stage, galvanized steel construction, <u>less power cord</u> , Quick Lock sink mount, 12-5/8" overall height, 4 year in-home warranty
--------	---------------------------	---

**FOR ADDITIONAL INFORMATION, VISIT THE INSINKERATOR
WEBSITE AT www.insinkerator.emerson.com**

INSINKERATOR HOT WATER TANKS









ID ORDER#	MODEL#	DESCRIPTION
693879	HWT-00 (44875)	INSTANT HOT WATER TANK , 2/3 gallon stainless steel tank (add for faucet – available on special order)
685601	HWT-F1000S (44723)	INSTANT HOT WATER TANK , 2/3 gallon stainless steel tank <u>with F1000S filter system</u> (add for faucet – available on special order)

**FOR ADDITIONAL INFORMATION, VISIT THE INSINKERATOR
WEBSITE AT www.insinkerator.emerson.com**

INSINKERATOR ACCESSORIES



	ID ORDER#	MODEL#	DESCRIPTION
	633397	QCB-AM	COLLAR SINK BAFFLE—ANTIMICROBIAL, QUIET , for Evolution disposers (not for use on Badger disposers)
	777724	HDW-00	HARDWIRE ADAPTER KIT FOR EZ CONNECT DISPOSERS
	576853	QLM-00	MOUNTING KIT WITH “TWIST ON/TWIST OFF” QUICK LOCK , polished stainless steel for most stainless steel sinks
	633395	DMG-00	MOUNTING GASKET—DELUXE , for stainless steel grind chamber only
	633396	MGK-00	MOUNTING GASKET KIT , with one standard and one deluxe gasket (not for use on Evolution disposers)
	47558	CRD-00	POWER CORD ASSEMBLY , includes 3' UL-listed cord, strain relief clamp and wire connectors (Note: not for EZ Connect disposers)
	77701	CRD-EZ	POWER CORD ASSEMBLY (EZ CONNECT) FOR EZ CONNECT DISPOSERS
	642370	STP-DS	STOPPER—DUAL POSITION , “SilverSaver”, polished stainless steel
	77104	STP-SS	STOPPER , stainless steel

**FOR ADDITIONAL INFORMATION, VISIT THE INSINKERATOR
WEBSITE AT www.insinkerator.emerson.com**



ID ORDER#	MODEL#	DESCRIPTION
--------------	--------	-------------

ACCESSORIES



152231	STS-OO	SINKTOP SWITCH—DUAL OUTLET , air activated, includes one chrome and one white button
729512	STS-OOSN	<i>Same as above</i> , but includes one satin nickel button



216592	STC-BLK	TOP SWITCH COVER , gloss black
741851	STC-CRB	<i>Same as above</i> , but classic oil rubbed bronze (coordinates with Delta, Brizo and Kohler)
621701	STC-ORB	<i>Same as above</i> , but oil rubbed bronze (coordinates with Moen)
726941	STC-PN	<i>Same as above</i> , but polished nickel
635454	STC-MTBLK	<i>Same as above</i> , but matte black

PARTS

443961	02610ST	ACCESSORY PACKAGE
443960	73237	<i>Same as above</i>
36058	1010A	MOUNTING GASKET , for all units but Badger Series
603084	74054	MOUNTING GASKET FOR EVOLUTION
2428	1491	SCREW
35603	1876	STOPPER ASSEMBLY , for Deluxe Series

**FOR ADDITIONAL INFORMATION, VISIT THE INSINKERATOR
WEBSITE AT www.insinkerator.emerson.com**

METPAR METAL TOILET PARTITIONS



NOTE: The BOCA BASIC/NATIONAL PLUMBING CODE/1984, 6th edition, Item P-1204.2 states that "water closet compartments shall not be less than 30" wide x 60" deep. An entirely different set of dimensions apply to handicap applications. Please make this determination with your inspection authority before ordering.

GREY ID#	BEIGE ID#	MODEL#	DESCRIPTION
----------	-----------	--------	-------------

STANDARD PARTITIONS

NOTE: Metpar partitions feature a baked enamel finish and include all necessary hardware. They are available in #700 Grey Dawn or #450 Sahara Beige. They are available by **SPECIAL ORDER ONLY**. Allow 7-10 days lead time.

CORNER UNITS

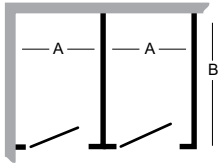

A. Stall width (max.) 38"
B. Stall depth 48", 57", 60"

41801 *	41800 *	C-1	SINGLE STALL CORNER UNIT
41803 *	41802 *	C-2	DOUBLE STALL CORNER UNIT
41805 *	41804 *	C-3	TRIPLE STALL CORNER UNIT
41807 *	41806 *	C-4	FOUR STALL CORNER UNIT
41809 *	41808 *	C-5	FIVE STALL CORNER UNIT
41811 *	41810 *	C-6	SIX STALL CORNER UNIT

RECESSED UNITS

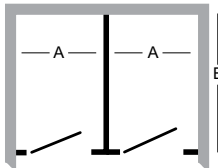

A. Stall width (max.) 38"
B. Stall depth 48", 57", 60"

41813 *	41812 *	R-1	SINGLE STALL RECESSED UNIT
41815 *	41814 *	R-2	DOUBLE STALL RECESSED UNIT
41817 *	41816 *	R-3	TRIPLE STALL RECESSED UNIT
41826 *	41824 *	R-4	FOUR STALL RECESSED UNIT
41828 *	41827 *	R-5	FIVE STALL RECESSED UNIT
41830 *	41829 *	R-6	SIX STALL RECESSED UNIT

ALCOVE UNITS

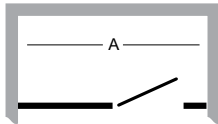

A. Stall width (max.) 84"

41832 *	41831 *	A-1	ALCOVE UNIT
---------	---------	-----	--------------------

URINAL SCREENS

41834 *	41833 *	WH-1-18	URINAL SCREENS , wall-hung, 18" x 42"
41835 *	41836 *	WH-1-24	Same as above, but 24" x 42"
41837 *	39050 *	PF-1-24	URINAL SCREENS , wall-hung and floor supported, 18" x 42"
41839 *	41838 *	PF-1-26	Same as above, but 26" x 70"
41841 *	41840 *	PF-1-30	Same as above, but 30" x 70"

PAPER HOLDERS

10616	--	SPH	SINGLE PAPER HOLDER , #460, vandalproof
41775 *	--	DPH	DOUBLE PAPER HOLDER , #460-D, vandalproof

FOR MORE INFORMATION, VISIT THE METPAR WEBSITE AT www.metpar.com

METPAR HANDICAP TOILET PARTITIONS



NOTE: The BOCA BASIC/NATIONAL PLUMBING CODE/1984, 6th edition, Item P-1204.2 states that "water closet compartments shall not be less than 30" wide x 60" deep. An entirely different set of dimensions apply to handicap applications. Please make this determination with your inspection authority before ordering.

GREY ID#	BEIGE ID#	MODEL#	DESCRIPTION
----------	-----------	--------	-------------

HANDICAP PARTITIONS

NOTE: Metpar partitions feature a baked enamel finish and include all necessary hardware. They are available in #700 Grey Dawn or #450 Sahara Beige. They are available by **SPECIAL ORDER ONLY**. Allow 7-10 days lead time.

HANDICAP CORNER UNITS

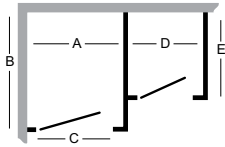

- A. Handicap width (max.) 44"
- B. Handicap stall depth 72" or 78"
- C. Handicap door width 34"
- D. Standard stall width 38"
- E. Standar stall depth 48", 57" or 60"

41739 *	41738 *	HC-1	SINGLE HANDICAP CORNER UNIT
41741 *	41740 *	HC-1-1	SINGLE HANDICAP CORNER STALL , with single standard stall
41743 *	41742 *	HC-1-2	SINGLE HANDICAP CORNER STALL , with two standard stalls
41745 *	41744 *	HC-1-3	SINGLE HANDICAP CORNER STALL , with three standard stalls
41747 *	41746 *	HC-1-4	SINGLE HANDICAP CORNER STALL , with four standard stalls
41749 *	41748 *	HC-1-5	SINGLE HANDICAP CORNER STALL , with five standard stalls

HANDICAP RECESSED UNITS

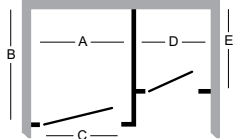

- A. Handicap width 42" to 44"
- B. Handicap stall depth 72" or 78"
- C. Handicap door width 34"
- D. Standard stall width 38"
- E. Standard stall depth 48", 57" or 60"

41751 *	41750 *	HR-1	SINGLE HANDICAP RECESSED UNIT
41753 *	41752 *	HR-1-1	SINGLE HANDICAP RECESSED STALL , with single standard stall
41755 *	41754 *	HR-1-2	SINGLE HANDICAP RECESSED STALL , with two standard stalls
41758 *	41756 *	HR-1-3	SINGLE HANDICAP RECESSED STALL , with three standard stalls
41762 *	41759 *	HR-1-4	SINGLE HANDICAP RECESSED STALL , with four standard stalls
41764 *	41763 *	HR-1-5	SINGLE HANDICAP RECESSED STALL , with five standard stalls

HANDICAP ALCOVE UNITS

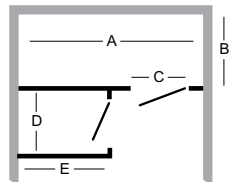

- A. Alcove width (max) 120"
- B. Handicap stall depth 78"
- C. Handicap door width 34"
- D. Standard stall width 38"
- E. Standard stall depth 48", 57" or 60"

41765 *	39049 *	HA-1	SINGLE HANDICAP ALCOVE UNIT
28367 *	39048 *	HA-1-1	SINGLE HANDICAP ALCOVE STALL , with single standard stall
41767 *	41766 *	HA-1-2	SINGLE HANDICAP ALCOVE STALL , with two standard stalls
41769 *	41768 *	HA-1-3	SINGLE HANDICAP ALCOVE STALL , with three standard stalls
41772 *	41771 *	HA-1-4	SINGLE HANDICAP ALCOVE STALL , with four standard stalls
41774 *	41773 *	HA-1-5	SINGLE HANDICAP ALCOVE STALL , with five standard stalls

FOR MORE INFORMATION, VISIT THE METPAR WEBSITE AT www.metpar.com

METPAR ADA-STYLE TOILET PARTITIONS



NOTE: The BOCA BASIC/NATIONAL PLUMBING CODE/1984, 6th edition, Item P-1204.2 states that "water closet compartments shall not be less than 30" wide x 60" deep. An entirely different set of dimensions apply to handicap applications. Please make this determination with your inspection authority before ordering.

GREY ID#	BEIGE ID#	MODEL#	DESCRIPTION
----------	-----------	--------	-------------

ADA-STYLE PARTITIONS

NOTE: Metpar partitions feature a baked enamel finish and include all necessary hardware. They are available in #700 Grey Dawn or #450 Sahara Beige. They are available by **SPECIAL ORDER ONLY**. Allow 7-10 days lead time.

ADA-STYLE CORNER UNITS

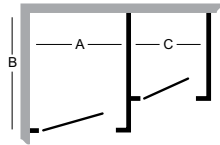

- A. Handicap width (min.) 60"
- B. Handicap stall depth 60"
- C. Standard stall width 38"

82064 *	82058 *	HCA-1	SINGLE ADA-STYLE CORNER UNIT
82065 *	82060 *	HCA-1-1	SINGLE ADA-STYLE CORNER STALL , with single standard stall
82066 *	82061 *	HCA-1-2	SINGLE ADA-STYLE CORNER STALL , with two standard stalls
82067 *	82062 *	HCA-1-3	SINGLE ADA-STYLE CORNER STALL , with three standard stalls
82072 *	82063 *	HCA-1-4	SINGLE ADA-STYLE CORNER STALL , with four standard stalls

ADA-STYLE RECESSED UNITS

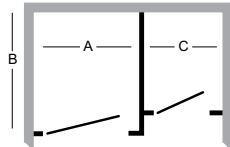







- A. Handicap width (min.) 60"
- B. Handicap stall depth 60"
- C. Standard stall width 38"

41751 *	41750 *	HRA-1	SINGLE ADA-STYLE RECESSED UNIT
41753 *	41752 *	HRA-1-1	SINGLE ADA-STYLE RECESSED STALL , with single standard stall
41755 *	41754 *	HRA-1-2	SINGLE ADA-STYLE RECESSED STALL , with two standard stalls
41758 *	41756 *	HRA-1-3	SINGLE ADA-STYLE RECESSED STALL , with three standard stalls
41762 *	41759 *	HRA-1-4	SINGLE ADA-STYLE RECESSED STALL , with four standard stalls



FOR MORE INFORMATION, VISIT THE METPAR WEBSITE AT www.metpar.com



	ID ORDER#	MODEL#	DESCRIPTION
	1408	07-49-251	BAR FAUCET—TWO-HANDLE "CLASSICS," metal fluted handles, 4" CC, chrome finish, 3-hole, 8-1/16" high gooseneck spout, 1.75 gpf
	1405	49-530	LAUNDRY TRAY FAUCET—TWO-HANDLE CLAMP-ON "CLASSICS," for old style masonry tubs, cast brass body and rough brass finish, cast spout with hose connection, clamp-on mounting, 1/2" IPS or 1/2" nominal copper sweat connections
	1407	07-49-244	LAUNDRY TRAY FAUCET—TWO-HANDLE "CLASSICS," metal fluted handles, 4" CC, chrome finish, 6" high swing spout, aerator, 1/2" IPS male shanks
	1404	47-920	SHOWER VALVE—"CLASSICS," 3-3/8" centers, with shower head and arm
	55074	41-510	TRIP LEVER PVC DRAIN FOR STANDARD TUB, with metal plunger, chrome finish, fits most tubs 14-16" high
	169724	41-513	TRIP LEVER PVC DRAIN FOR ROMAN TUB, with metal plunge, chrome finish, fits most tubs 24" high
	693751	48-030	TUB & SHOWER VALVE—"CLASSICS," 3-3/8" centers, chrome trim, three handle IPS/sweat connections, threaded spout, 2.0 Gpf
	693750	48-720	TUB & SHOWER VALVE & TRIM, chrome
	1409	98-710	WASHERLESS CARTRIDGE, hot, complete, for 80 Series
	1410	98-711	<i>Same as above,</i> but cold



FOR ADDITIONAL INFORMATION, VISIT THE GERBER BRASS WEBSITE AT www.gerber-us.com



	ID ORDER#	MODEL#	DESCRIPTION
	633610	B-0230-EELN	PANTRY FAUCET—DOUBLE , lead free, <u>less spout</u> , wall-mount, 8"CC, polished chrome finish, plated brass body, swivel outlet, compression cartridges with spring checks, two lever handles, 1/2" "EE" inlets, aerator, add spout for complete faucet
	230692	062X	12" SWING SPOUT , with 3-3/4" clearance





FOR ADDITIONAL INFORMATION, VISIT THE T&S BRASS WEBSITE AT: www.tsbrass.com

SPEAKMAN SHOWER SYSTEMS

ID ORDER#	MODEL#	DESCRIPTION
	740075 * SC-1240-LH + S-2762	<p>SHOWER SYSTEM KIT, includes #SC-1240-LH outdoor 2-handle shower system and #S-2762 Neo rain round shower head</p> <p>Shower system includes brass body, (2) 1/2"-14 NPTF inlets, reversible valve body, vandal-resistant cross handles with color-coded indexes, 1/4 turn ceramic cartridges, exposed rough chrome-plated shower body assembly on 6" CC, polished stainless steel rain shower with 15-1/2" arm and supporting strap, ASME A112.18.1/CSA B125.1 certified, 5 year limited warranty</p> <p>Neo rain round shower head includes solid brass construction, polished chrome finish, 105 full-coverage sprays, 2.5 gpf flow rate, 1/2" NPT inlet</p>
	740076 * SC-1240-LH + S-2763	<p>Same as above, but with #S-2763 Kubos rain square shower head which includes solid brass construction, polished chrome finish, 100 full-coverage sprays, 2.5 gpf flow rate, 1/2" NPT inlet</p>
<p>PARTS</p> 	740345 RPG05-0917	CARTRIDGE , single control

**FOR ADDITIONAL INFORMATION, VISIT THE
SPEAKMAN BRASS WEBSITE AT: www.speakman.com**





	ID ORDER#	MODEL#	DESCRIPTION
	776359	MT403-NL/BRN	BALL VALVE—ANGLE , brass, oval handle, 1/4 turn, lead free, 1/2" compression (5/8" OD) inlet x 3/8" OD compression outlet, brushed nickel finish
	776358	MT403-NL/VB	<i>Same as above</i> , but Venetian bronze
	776360	MT403-NL/MB	<i>Same as above</i> , but matte black finish
	776362	MT410-NL/BRN	BALL VALVE—STRAIGHT , brass, oval handle, 1/4 turn, lead free, 1/2" compression (5/8" OD) inlet x 3/8" OD compression outlet, brushed nickel finish
	776361	MT410-NL/VB	<i>Same as above</i> , but Venetian bronze
	776363	MT410-NL/MB	<i>Same as above</i> , but matte black finish
	776846	UNVTRIM/BRN	DRAIN TRIM KIT—TRIM ONLY , with EZ-Click "soft touch" drain mechanism, fits drain bodies with 1-1/2" to 11-1/2" NPSM thread with bushing or 1-3/8" to 16" fine thread, designer face plate with no holes, suitable for most overflows with 1 or 2 screw installation, brushed nickel finish
	776848	UNVTRIM/VB	<i>Same as above</i> , but Venetian bronze
	776847	UNVTRIM/MB	<i>Same as above</i> , but matte black finish
	776370	MT441X/BRN	FLANGE—SURE GRIP , flat, brass, fits over 5/8" OD copper tube, 5/8" ID x 2-1/2" OD x 13/32" ht, brushed nickel finish
	776372	MT441X/VB	<i>Same as above</i> , but Venetian bronze
	776371	MT441X/MB	<i>Same as above</i> , but matte black finish
	776364	MT432X/BRN	LAV SUPPLY TUBE—BULL NOSE , with metal end for lavatory connection, 3/8" OD X 20" long, lead free, brushed nickel finish
	776365	MT432X/VB	<i>Same as above</i> , but Venetian bronze
	776366	MT432X/MB	<i>Same as above</i> , but matte black finish
	776376	MT4820BO-NL/BRN	LAVATORY SUPPLY KIT , with MT403-NL angle ball valve, MT436X flat head lavatory supply tube, and MT441X sure grip flange, brushed nickel finish
	776380	MT4820BO-NL/VB	<i>Same as above</i> , but Venetian bronze
	776379	MT4820BO-NL/MB	<i>Same as above</i> , but matte black finish

**FOR ADDITIONAL INFORMATION, VISIT THE
MOUNTAIN PLUMBING PRODUCTS WEBSITE AT: www.mountainplumbing.com**



MOUNTAIN PLUMBING SUPPLIES & FITTINGS



ID ORDER#	MODEL#	DESCRIPTION
	776367 MT436X/BRN	TOILET SUPPLY TUBE—FLAT HEAD , with plastic end for toilet connection, 3/8" OD X 20" long, lead free, brushed nickel finish
	776369 MT436X/VB	<i>Same as above</i> , but Venetian bronze
	776368 MT436X/MB	<i>Same as above</i> , but matte black finish
	776381 MT493BO-NL/BRN	TOILET SUPPLY KIT , with MT403-NL angle ball valve, MT432X bullnose lavatory supply tube, and MT441X sure grip flange, brushed nickel finish
	776383 MT493BO-NL/VB	<i>Same as above</i> , but Venetian bronze
	776382 MT493BO-NL/MB	<i>Same as above</i> , but matte black finish
	776381 MT3140/BRN	P-TRAP WITH HIGH BOX FLANGE , 1-1/4" x 1-1/4" P-trap (17 gauge brass), 3" dia x 1-1/4" high box flange, brushed nickel finish
	776383 MT3140/VB	<i>Same as above</i> , but Venetian bronze
	776382 MT3140/MB	<i>Same as above</i> , but matte black finish

FOR ADDITIONAL INFORMATION, VISIT THE
MOUNTAIN PLUMBING PRODUCTS WEBSITE AT: www.mountainplumbing.com



	ID ORDER#	MODEL#	DESCRIPTION
	600871	151.506.00.1	PVC ROUGH-IN , 17"-24" tub depth, 27" cable length, 1-1/2" PVC Schedule 40 for glued joint (less pipes), fits 1/16"-5/16" tub wall thickness.
	633062	151.550.11.1	TRIM KIT—PLASTIC WASTE AND OVERFLOW , includes handle and plunger, Alpine white
	613246	151.550.21.1	Same as above, but polished chrome
	600872	151.550.AA.1	Same as above, but bone
	613248	151.550.FF.1	Same as above, but biscuit
	776207	151.550.16.1	Same as above, but matte black
	613241	151.551.1D.1	TRIM KIT—TRADITIONAL METAL WASTE AND OVERFLOW , includes handle and plunger, Forevershine PVD brushed nickel
	632916	151.551.HM.1	Same as above, but hard coat oil rubbed bronze

FOR ADDITIONAL INFORMATION, VISIT THE GEBERIT WEBSITE AT www.geberitnorthamerica.com







ID ORDER#	MODEL#	DESCRIPTION
 733090	EC-1-DV (553507)	CONDENSATE PUMP , for mini-split, dual voltage 110-240V, 50/60 Hz, 2.5 gph @ 1 foot flow, 33' shut-off, hall effect switching, large inlet filter, multi-size hose drain adapter fits most drain hose connectors
 756855	VCCA-20ULS (554201101)	CONDENSATE PUMP , for low-profile applications, 115V, 1/30 HP motor, 1/4-turn twist-off check valve discharge adapter for 3/8" ID tubing, check valve adapter for 1/4" ID vinyl tubing, pump switch test lever, rubber feet, 3-inlet openings overflow detection switch, ABS tank, motor cover and volute, intermittent liquid temperature up to 120°F, stainless steel motor shaft, thermal overload protection
 657809	VCMA-15UL (554401)	CONDENSATE PUMP , 1/50 HP motor, ABS tank, motor cover and volute, 1/2 gallon tank capacity, stainless steel shaft, snap-action switch, removable 3/8" barbed check valve, 3 inlet drain holes, thermal overload protection, 20' of 3/8" ID tubing, safety switch
 699262	VCMA-20ULS-PRO (554630)	CONDENSATE PUMP , 1/30 HP motor, fully automatic start, stop and safety switch, 3/8" check valve outlet for 3/8" ID (=VCMX-20ULS / 554530)
 650828	9SC-CIA-RF (509412)	SEWAGE PUMP , PSC motor, energy-saving, low-amp draw, 2" FNPT discharge handles up to 2" diameter solids, multiple switch options for automatic operation, 140°F liquid temperature rating
 650833	6EC-CIA-SFS (506807)	SUMP PUMP , PSC motor with thermal overload protection, heavy-duty cast iron construction, continuous duty energy-saving, low-amp draw, 1-1/2" FNPT discharge, handles up to 1/2" diameter solids, multiple switch options for automatic operation, 140°F liquid temperature rating
 136632	WRSC-6 (506065)	SUMP PUMP—“DRAINOSAUR” , 115V, 1/3 HP, lightweight, corrosion-resistant, water-tight seal, removable filter, 1-1/2" FNPT discharge and intake opening, 2" FNPT vent opening, IAPMO certified
 705049	5-MSP (505000)	UTILITY TRANSFER PUMP—SUBMERSIBLE , 1200 GPH, bottom intake with pre-screen, epoxy-coated cast, aluminum pump housing
 705051	UPSP-5 (555104)	UTILITY TRANSFER PUMP—PORTABLE IN-LINE , non-submersible, all cast iron with integral carrying handle, self-priming to 15' when priming chamber is filled, removable priming chamber plug with O-ring seal, 3/4" brass garden hose intake and discharger adapters, thermoplastic impeller, 3/4" FNPT discharge, 140°F liquid temperature rating



FOR ADDITIONAL INFORMATION, VISIT THE LITTLE GIANT WEBSITE AT: www.littlegiant.com

LITTLE GIANT ACCESSORIES



	ID ORDER#	MODEL#	DESCRIPTION
	142076	CV-10 (599065)	CHECK VALVE , for VCC and VCMA series and VCL-14/24 pumps, 1/4" MNPT to 3/8" OD rigid plastic or copper tubing
	127586	RFSN-9 (599117)	FLOAT SWITCH , 1/2 to 1 HP, 115/230V, 13 amp, includes one float, 15' cord with piggy-back plug, mounting strap and two adjustable mounting clamps
	135836	HW-9 (513379)	HIGH WATER ALARM , remote sensor, 85 decibel alarm sounds for 3 days, 9V (battery not included), wall-mounting hardware, suction cup and adhesive, circuit test/reset button, low battery signal
	128339	950337	ON/OFF SWITCH , 5 amp, 250VAC
	665057	SPRK-2-ML (599314)	SWITCH REPAIR KIT , includes pressure switch bracket assembly, screw, diaphragm and O-ring

FOR ADDITIONAL INFORMATION, VISIT THE LITTLE GIANT WEBSITE AT: www.littlegiant.com









	ID ORDER#	MODEL#	DESCRIPTION
	743553	E2-2200	SUMP PIT KIT , #E2-2200 structural foam basin, #E-C18TSFG2 2-piece cover with 4 grommets, 18" x 22", 22 gallon capacity, can accommodate multi-pump applications, 1 year warranty to original owner
	757392	E3-24001	SEWAGE PIT KIT , #E3-24001 structural foam sewage basin, #E-C18TSFG2 2-piece cover with 4 grommets, 18" 30", 30 gallon capacity, will accommodate most sewage pumps, 1 year warranty to original owner

SINK WASTE & ACCESSORIES

	743376	CVSUMPR	SUMP CHECK VALVE—2-IN-1 , 1-1/4" to 1-1/2"
	743587	CV200R	SWING CHECK VALVE , 2"

FOR ADDITIONAL INFORMATION, VISIT THE
TOPP INDUSTRIES WEBSITE AT: www.toppindustries.com



	ID ORDER#	DB BRASS MODEL#	KEENEY MODEL#	DESCRIPTION	CTN QTY
TRAPS					
	2472	701DF-1	301CPDF	P TRAP , 1-1/4", 17 gauge brass, less cleanout, deep flange	25
	2473	704DF-1	305CPDF	<i>Same as above</i> , but 1-1/2"	25
	76512	P9701BG	200W2	P TRAP , 1-1/4", PVC, less cleanout	25
	2748	P9704BG	400TTW	P TRAP , 1-1/2" x 11", PVC, with Schedule 40 adapter and 3 nuts	50
	2476	719-1	325CP	S TRAP , 1-1/4", 17 gauge brass, less cleanout, low flange	5
	2750	P9722	700W	S TRAP , 1-1/2" x 20-1/2", PVC, with Schedule 40 adapter and 3 nuts	25
TAILPIECES					
	2496	814A-1	48SN	BRANCH TAILPIECE , 1-1/2" x 6", 20 gauge brass	10
	61038	PP9818	31-8W	BRANCH TAILPIECE FOR DISHWASHER , 1-1/2" x 8", PVC, direct connect, hi-line with 1/2" branch	25
	61040	PP9816	33-8W	<i>Same as above</i> , but with slip joint connection	25
	2501	799-17-3	140PC	FLANGED STRAINER TAILPIECE , 1-1/2" x 4", 17 gauge rough brass	10
	2502	800-17-1	141PC	<i>Same as above</i> , but 1-1/2" x 6"	10
	2504	803-17-3	144PC	<i>Same as above</i> , but 1-1/2" x 12"	10
	2754	P9803EC	11-16PVC	FLANGED TAILPIECE , 1-1/2" X 16", PVC, double end, white	25

FOR ADDITIONAL INFORMATION, VISIT THE OATEY WEBSITE AT www.oatey.com



	ID ORDER#	DB BRASS MODEL#	KEENEY MODEL#	DESCRIPTION	CTN QTY
EXTENSIONS					
	2505	790-17BN-1	7901PC	EXTENSION TUBE , 1-1/4" x 6", 17 gauge brass, for slip joint	10
	2507	791A-17-A	7903PC	Same as above, but 1-1/4" x 12"	10
	2508	792-17-1	7904PC	Same as above, but 1-1/2" x 6"	10
	2510	793A-17-1	7906PC	Same as above, but 1-1/2" x 12"	10
	733757	P9791E	--	EXTENSION TUBE , 1-1/4" x 16", PVC, slip joint, double end, white	25
	2755	P9793E	41-16PVC	Same as above, but 1-1/2" x 16"	25
	2513	820C-1	1772PC	THREADED TUBE , 1-1/4" x 8", 17 gauge brass, both ends	10
	2527	827A-1	1776PC	Same as above, but 1-1/2" x 12"	10
	2528	1046-17BN-1	7037PC	OFFSET TRAP CONNECTION , 1-1/4" x 9-1/2" OD, 17 gauge brass, with double slip joint	5
	2529	1046A-17BN-1	7038PC	Same as above, but 1-1/2" x 10"	5
SINK WASTE & ACCESSORIES					
	2530	133A-1	1569ASN	SINK WASTE , 1-1/2" x 16", 17 gauge brass, center outlet, <u>direct connect</u>	5
	2532	131A-1	1816ASN	Same as above, but end outlet	10
	2536	111A-1	1816SN	SINK WASTE , 1-1/2" x 16", 17 gauge brass, end outlet, slip joint	10
	2751	P9121ABG	120W	SINK WASTE , 1-1/2" x 16", PVC, two part, end outlet with baffle tee, <u>slip joint or direct connect</u>	25
	25804	P9213ABG	222W	Same as above, but center outlet	25
	2753	P9100TB	335W	DISPOSER KIT , 1-1/2", PVC, less trap, includes 6" and 4" sink tailpiece, end outlet tee and tailpiece	25



FOR ADDITIONAL INFORMATION, VISIT THE OATEY WEBSITE AT www.oatey.com



ID ORDER#	DB BRASS MODEL#	KEENEY MODEL#	DESCRIPTION	CTN QTY	
SINK WASTE & ACCESSORIES					
	152381	P9121AT	121W	CONTINUOUS WASTE , 1-1/2" x 11"-17", PVC, end outlet with baffle tee, slip joint, white adjustable with telescopic tee, bagged	25
	150705	P9121ATBG	120AW	Same as above, but 1-1/2" x 11-17", slip joint or direct connect	25
	49262	P9121T	125A-21W	END WASTE , 1/2" x 17", direct connection only	25
	152382	P9121AT-8	127W	END OUTLET WASTE , 1-1/2" x 11"-17", slip joint connection with hi-line (flanged) adapter with telescopic waste arm, 1/2" branch	25
	762013	230-240616101 (Sioux Chief)	127AW	END OUTLET WASTE , 1-1/4" X 8", 17 gauge	25
	2569	764A-17-1	1614C	OVERFLOW PO PLUG , 1-1/2" x 16", direct connect	25
NUTS, GASKETS & WASHERS & GASKETS					
	2563	8007	915PC	SLIP JOINT NUT , 1-1/4" IPS x 1-1/4" slip joint, brass, chrome plated	50
	2565	8006	918PC	Same as above, but 1-1/2" IPS x 1-1/2" slip joint	50
	123748	7556	--	FLANGED CLOSET GASKET , sponge rubber	10
	22477	7196	57	FLANGED WASHER , 1-1/4", plastic	100
	11997	9002	65	Same as above, but 1-1/2"	100
	467111	7202	--	Same as above, but for IPS nut	100
	2558	7203	50918RU	Same as above, but 1-1/2" IPS x 1-1/2" slip joint	100
	63338	4028	(Jones) C27-150	SPUD—CLOSET , 1-1/2" x 1-1/2", brass	6
	119955	--	(Jones) C27-301	SPUD GASKET WASHER , 1-1/4", for closets or urinals	25
	119958	--	(Jones) C27-302	Same as above, but 1-1/2" (=Sioux Chief #490-11522)	1
	119959	--	(Jones) C27-303	Same as above, 2"	25
	74898	4030	(Jones) C27-134	SPUD—URINAL , brass, 1" x 3/4"	6





FOR ADDITIONAL INFORMATION, VISIT THE OATEY WEBSITE AT www.oatey.com



	ID ORDER#	DB BRASS MODEL#	KEENEY MODEL#	DESCRIPTION	CTN QTY
TUB & SHOWER ACCESSORIES					
	2756	P9226	64W	TUB WASTE & OVERFLOW—ADJUSTABLE , 1-1/2", PVC trip lever style, adjustable 11-1/2" to 14-1/2" height, exposed parts chrome metal	10
	2571	226-3	607RB	TUB WASTE & OVERFLOW , 1-1/2", 17 gauge brass, trip lever style, exposed parts chrome metal (=#226-17-3)	1
	78827	P7224B	631PVC	TOUCH-TOE FOOTLOCK STOP BATH WASTE KIT , 1-1/2", PVC	20

FOR ADDITIONAL INFORMATION, VISIT THE OATEY WEBSITE AT www.oatey.com



ID ORDER#	DB BRASS MODEL#	KEENEY MODEL#	DESCRIPTION	CTN QTY	
COMMERCIAL SPEC-GRADE LAV ACCESSORIES					
	123788	507-1	5303PC	P TRAP , 1-1/4", 17 gauge material, semicast with cleanout and brass nuts	12
	123789	510-1	5307PC	<i>Same as above</i> , but 1-1/2" and with deep flange and nuts	12
	721665	759-1	--	POP-UP ASSEMBLY , 1-1/4", 20 gauge brass, chrome finish, for use with lavatory sink drain	10
	62961	760-1	5680PC	LAVATORY GRID DRAIN—COMMERCIAL , cast brass with polished chrome finish and open grid strainer (=Kohler #7715-CP)	25
	62962	760W-1	5700PC	LAVATORY OFFSET GRID DRAIN—HANDICAP , 1-1/4" x 5", polished chrome with strainer and drain assembly, 17 gauge tailpiece, 5" offset (=Kohler #13885-CP)	10

FOR ADDITIONAL INFORMATION, VISIT THE OATEY WEBSITE AT www.oatey.com



	ID ORDER#	DB BRASS MODEL#	KEENEY MODEL#	DESCRIPTION	CTN QTY
SINK ACCESSORIES					
	62842	3784	878PC	SINK STRAINER—JUNIOR , fits 2" or 2-1/2" sink openings, stainless steel basket, nuts, washers, grid, <u>less rubber stopper</u>	12
	2583	774	879PC	Same as above, but with flat top and <u>includes rubber stopper</u>	12
	62964	17	1433SS	SPIN-N-LOCK BASKET STRAINER , fits 3-1/2" or 4" sink openings, stainless steel, neoprene stopper	24
	721875	16	--	LOCKING CUP BASKET STRAINER , 1-1/4" x 8", 17 gauge brass, both ends	24
	781607	W9107	--	SINK HOLE COVER , 1-3/4", polished chrome	25
FLANGES					
	2587	1116	866PC	BOX FLANGE (DEEP) , 1-1/4" OD, polished chrome	12
	2694	1117	867PC	Same as above, but 1-1/2" OD	12
	2697	1109	860PC	HIGH FLANGE , 3/8" IPS, polished chrome	50
	2699	1109C	(Jones)E07-050	Same as above, but 1/2" NOM	50
	2701	1115	859PC	Same as above, but 1-1/2" OD	50
	2702	1100	850PC	LOW FLANGE—SHALLOW , 3/8" IPS, polished chrome	50
	2703	1101	851PC	Same as above, but 1/2" IPS	50
	2704	1099	850CPC	Same as above, but 1/2" NOM	50
	67311	1099A	851CPC	Same as above, but 3/4" NOM	50
	2707	1106	856PC	Same as above, but 1-1/2" IPS	50
FLOOR & CEILING PLATES					
	2708	5350	102-3/8	FLOOR & CEILING PLATE , 3/8" IPS, spring loaded, split flange	12
	2709	5351	102-1/2	Same as above, but 1/2" IPS	12
	2710	5352	102-3/4	Same as above, but 3/4" IPS	12
	2711	5353	102-1	Same as above, but 1" IPS	12
	2712	5354	102-1-1/4	Same as above, but 1-1/4" IPS	12
	2713	5355	102-1-1/2	Same as above, but 1-1/2" IPS	12
	2714	5356	102-2	Same as above, but 2" IPS	12

FOR ADDITIONAL INFORMATION, VISIT THE OATEY WEBSITE AT www.oatey.com

SEPTEMBER 2024

Line #2900

DEARBORN BRASS PLUMBING SPECIALTIES

222.6



ID ORDER#	DB BRASS MODEL#	KEENEY MODEL#	DESCRIPTION	CTN QTY	
GRAB BARS					
	63002	DB8712	PP19360	GRAB BAR , 1-1/4" x 12", smooth, satin finish, 18 gauge/type 304 stainless steel with concealed flanges, shipped with #10 x 1-1/4" screws	4
	63004	DB8718	PP19362	Same as above, but 1-1/4" x 18"	4
	63005	DB8724	PP19363	Same as above, but 1-1/4" x 24"	4
	63007	DB8732	PP19364	Same as above, but 1-1/4" x 32"	4
	63008	DB8736	PP19365	Same as above, but 1-1/4" x 36"	4
	63009	DB8742	PP19366	Same as above, but 1-1/4" x 42"	4

FOR ADDITIONAL INFORMATION, VISIT THE OATEY WEBSITE AT www.oatey.com

BRASSCRAFT SUPPLIES & FITTINGS



ID ORDER#	MODEL#	DESCRIPTION	SIZE	CONNECTION	CTN QTY
CONNECTORS/RISERS					
3389	1-12DL-C	CLOSET RISER , with insert gasket, chrome finish	3/8" OD x 12"	--	100
3390	1-20DL-C	<i>Same as above</i> , but 20"	3/8" OD x 20"	--	100
49624	P1-12DL	CLOSET RISER , with plastic sleeve	3/8" OD x 12"	--	100
49625	P1-20DL	<i>Same as above</i> , but 20"	3/8" OD x 20"	--	100
49512	B1-12DLF	CLOSET RISER (SUPPLY) , 12", braided	3/8" x 7/8"	COMP x ballcock nut	25
767974	B1-16DLF	<i>Same as above</i> , but 16"	3/8" x 7/8"	COMP x ballcock nut	25
201637	B1-20DLF	<i>Same as above</i> , but 20"	3/8" x 7/8"	COMP x ballcock nut	25
202569	B1-12DWF	DISHWASHER CONNECTOR , 12", braided	3/8" x 3/8"	COMP x COMP	10
658609	B1-72DW12F	DISHWASHER CONNECTOR , with 3/4" garden hose elbow, 72"	3/8" x 3/8"	COMP x COMP	10
693320	HES-6-12X1	DISHWASHER ELBOW , brass, lead-free	3/8" x 3/4"	OD COMP x GH	50
40014	B1-12AF	FAUCET CONNECTOR , 12", braided	3/8" x 1/2"	COMP x FIP	25
154742	B1-20AF	<i>Same as above</i> , but 20"	3/8" x 1/2"	COMP x FIP	25
742334	B1-30AF	<i>Same as above</i> , but 30"	3/8" x 1/2"	COMP x FIP	25
169879	B1-12KCF	FAUCET CONNECTOR , 12", braided	3/8" x 3/8"	COMP x COMP	25
169880	B1-20KCF	<i>Same as above</i> , but 20"	3/8" x 3/8"	COMP x COMP	25
669331	HU22-12-12TPX	GARDEN HOSE CONNECTOR (FITTING) , brass, lead-free (=#HES-6-12X)	3/8" x 3/4" (tapped at 1/2")	male hose thread x MIP	25
682704	B0-72IMF	ICEMAKER HOSE , poly-braided, 72"	1/4" x 1/4"	COMP x COMP	10
3382	1-12A-C	LAVATORY RISER , copper, chrome finish with nose piece	3/8" OD x 12"	--	100
3383	1-20A-C	<i>Same as above</i> , but 20"	3/8" OD x 20"	--	100
3384	1-30A-C	<i>Same as above</i> , but 30"	3/8" OD x 30"	--	100
45822	1-20A-PP	LAVATORY RISER , polished brass finish	3/8" OD x 20"	--	2

FOR ADDITIONAL INFORMATION, VISIT THE BRASSCRAFT WEBSITE AT www.brasscraft.com

BRASSCRAFT SUPPLIES & FITTINGS



ID ORDER#	MODEL#	DESCRIPTION	SIZE	CONNECTION	CTN QTY
CONNECTORS/RISERS (Continued)					
49620	P1-12A	LAVATORY RISER , plastic, with plastic sleeve	3/8" OD x 12"	--	100
49621	P1-20A	<i>Same as above</i> , but 20"	3/8" OD x 20"	--	100
49622	P1-30A	<i>Same as above</i> , but 30"	3/8" OD x 30"	--	50
49623	P1-36A	<i>Same as above</i> , but 36"	3/8" OD x 36"	--	50
3386	1-12KC-C	LAVATORY RISER , polished brass finish	3/8" OD x 12"	COP x COMP	50
3387	1-20KC-C	<i>Same as above</i> , but 20"	3/8" OD x 20"	COP x COMP	50
ESCUTCHEONS					
79264	646	ESCUTCHEON—SHALLOW , stainless steel	3/8" IP	--	50
79265	647	<i>Same as above</i>	1/2" IP	--	50
75844	649	<i>Same as above</i> , but 20"	5/8" OD	(1/2" nom, 3/8" IP)	50
STOP VALVES—ANGLE					
3402	OR37-C	ANGLE STOP VALVE , chrome finish	1/2" x 1/2" OD	FIP x COMP	60
3406	R39-C	ANGLE STOP VALVE , chrome finish	1/2" x 1/2" OD	sweat x COMP	10
669358	OCR09X-C	ANGLE STOP VALVE—<u>LEAD FREE</u> , chrome finish	1/2" x 1/4" OD	COMP x COMP	60
669336	OCR19X-C	<i>Same as above</i>	1/2" x 3/8" OD	COMP x COMP	60
669330	G2PS19X-C	ANGLE STOP VALVE—<u>LEAD FREE</u> , chrome finish	1/2" x 3/8" OD	push-conn x COMP	60
669350	OR15X-C	ANGLE STOP VALVE—<u>LEAD FREE</u> , chrome finish	3/8" x 3/8" OD	FIP x OD COMP	60
669351	OR17X-C	<i>Same as above</i>	1/2" x 3/8" OD	FIP x OD COMP	60

FOR ADDITIONAL INFORMATION, VISIT THE BRASSCRAFT WEBSITE AT www.brasscraft.com

SEPTEMBER 2024

Line #1640

BRASSCRAFT SUPPLIES & FITTINGS







223.2



ID ORDER#	MODEL#	DESCRIPTION	SIZE	CONNECTION	CTN QTY
STOP VALVES—STRAIGHT					
669333	OCR14X-C	STOP VALVE—STRAIGHT—<u>LEAD FREE</u>, chrome finish	1/2" x 3/8" OD	COMP x COMP	60
45852	OCR14-P	STRAIGHT STOP VALVE, polished brass finish	1/2" x 3/8" OD	COMP x COMP	10
3392	OCR34-C	STRAIGHT STOP VALVE, chrome finish	1/2" x 1/2" OD	COMP x COMP	10
669298	OR10X-C	STRAIGHT STOP VALVE—<u>LEAD FREE</u>, chrome finish	3/8" x 3/8" OD	FIP x OD COMP	60
669349	OR12X-C	<i>Same as above,</i> but 12" length	1/2" x 3/8" OD	FIP x OD COMP	60
669354	R14X-C	STRAIGHT STOP VALVE—<u>LEAD FREE</u>, chrome finish	1/2" x 3/8" OD	nom. sweat x COMP	5
669355	R19X-C	<i>Same as above</i>	1/2" x 3/8" OD	nom. sweat x COMP	5
669357	R39X-C	<i>Same as above</i>	1/2" x 1/2" OD	nom. sweat x COMP	5
669329	G2PS14X-C	STRAIGHT STOP VALVE—<u>LEAD FREE</u>, chrome finish	1/2" x 3/8" OD	push-conn. x comp.	1









FOR ADDITIONAL INFORMATION, VISIT THE BRASSCRAFT WEBSITE AT www.brasscraft.com

ZURN FLUSH VALVE PARTS

	ID ORDER#	MODEL#	DESCRIPTION
FAUCETS			
	226998	zum.	AQUASPEC FAUCET—SERVICE SINK , polished chrome, lever handle, lead free
	353585	Z843M1-RC	Same as above, but with rough chrome finish
	632242	Z812A4-XL	AQUASPEC FAUCET—LAV , 4" CC, lead free
FLOOR DRAINS			
	146331	FD2210-PV3	FLOOR DRAIN—ADJUSTABLE , 3" PVC body with adjustable nickel bronze head and secured grate
	733775	EZ1-PV2	FLOOR DRAIN—ROUND , PVC, with 5" nickel bronze strainer and 2" x 3" PVC solvent weld outlet
	248482	P415-2NH-P-SA-CPT	FLOOR NO-HUB DRAIN BODY , with <u>trap primer</u> and clamp collar, 2", add for strainer
	198216	P415-3NH-P-SA-CPT	Same as above, but 3"
	248481	P415-4NH-P-SA-CPT	Same as above, but 4"
	50527	P415-4NH-SA-CPT	Same as above, but <u>less trap primer</u>
FLOOR DRAIN STRAINERS			
	50537	ZN400-5B	FLOOR DRAIN STRAINER , 5", nickel bronze
	50539	ZN400-6B	Same as above, but 6"

FOR ADDITIONAL INFORMATION, VISIT THE ZURN WEBSITE AT: www.zurn.com

ZURN FLUSH VALVE PARTS

	ID ORDER#	MODEL#	DESCRIPTION
FLUSH VALVES			
	756640	ZERK-CPM	AQUASENSE E-Z FLUSH RETROFIT KIT , with chrome-plated metal cover, sensor, override button
	725137	Z6000-HET-YB-YC	CLOSET FLUSH VALVE , manual, 1.28 gpf, polished chrome finish, top spud fixture connection, single flush
	74902	Z6000-WS1-YB-YC	CLOSET FLUSH VALVE , manual, 1.6 gpf with sweat kit for 1" tap, chrome finish, top spud fixture connection, single flush
	70404	Z6000-YB-YC	<i>Same as above</i> , but 3.5 gpf
	725138	Z6003-EWS-YB-YC	URINAL FLUSH VALVE , manual, 0.5 gpf with sweat kit, chrome finish, top spud fixture connection, single flush
	92251	Z6003-WS1-YB-YC	URINAL FLUSH VALVE , manual, 1.0 gpf with sweat kit for 3/4" tap
	70403	Z6003-YB-YC	<i>Same as above</i> , but 1.5 gpf
LAVATORY & URINAL KITS			
	91864	Z1231-UNIV-80	LAVATORY CARRIER KIT , includes (2) 36" legs and (1) #ARM-80 accessory box with arms and other accessories (=Z1231-80)
	123212	Z1222-F/K-4960	URINAL CARRIER KIT , includes (2) 48" legs and (1) #Z1222 accessory box with arms and other accessories

FOR ADDITIONAL INFORMATION, VISIT THE ZURN WEBSITE AT: www.zurn.com

ZURN FLUSH VALVE PARTS









ID ORDER#	MODEL#	DESCRIPTION
72898	P6000-VC	CAP , 1", chrome, vandal resistant (=PS6000C33)
72901	P6000-EC13	CLOSET RELIEF VALVE , white
74903 200098	P6000-ECR-WS1 P6000-ECR-FF	CLOSET REPAIR KIT , 1.6 gpf, (=P6000ECWS1) Same as above, but 4.5 gpf, (=P6000-ECA-FF-RK)
72908 72907	P6000-EER P6000-ER15	DIAPHRAGM REPAIR KIT (=P6000EE and Z6000EE) Same as above, but with chemical-resistant GO BLUE material (=Z6000E15 and P6000-E15)
72909	P6000-M-ADA	HANDLE ASSEMBLY , chrome
72910	P6000-MK	HANDLE REPAIR KIT (=Z6000MK and 563480023)
72893 72918	P6003-C-SD-CP P6000-C-SD-CP	SCREWDRIVER STOP , 3/4" (=Z6000C and 562970013) Same as above, but 1" (=Z6000C and 562990013)
72916 72917	P6001-H P6000-H	SPUD COUPLING , 1-1/4" Same as above, but 1-1/2"
72912 72920	P6003-H27 P6001-H27	SPUD GASKET , 3/4" Same as above, but 1-1/4" (=Z6000H24 and 540280029)
82687 72903	PS6003-D P6000-D-SD	STOP VALVE REPAIR KIT , 3/4" (=PS6000-D) Same as above, but 1" (=P6000D and 563770013)
72894 72895	P6000-J1 P6000-J2	TAILPIECE ASSEMBLY , 2-1/8", chrome (=563420013) Same as above, but 2-3/4" (=Z6000J2 and 563420023)
72913	P6000-C31	TAILPIECE O-RING , (Z6000C31 and 237502739)
72902	P6000-EU13	URINAL RELIEF VALVE
249290 72900	P6000-EUR-WS1 P6000-EUR-FF-CS	URINAL REPAIR KIT , 1.0 gpf Same as above, but 3.0 gpf (=P6000-EUR-FF)
72914 72923 72924	P6003-A-AA-CP P6001-A-AA-CP P6000-A-AA-CP	VACUUM BREAKER FLUSH TUBE , 3/4" x 9" Same as above, but 1-1/4" x 9" (=Z6000A and 563320263) Same as above, but 1-1/2" x 9"
72905	P6000-B-HP	VACUUM BREAKER REPAIR KIT—HIGH PRESSURE (=Z6000B and P6000B)
247330	JP1996-SF-VB-RK	VACUUM BREAKER REPAIR KIT (AQUASPEC) (=58099-1 and 584059999)

FOR ADDITIONAL INFORMATION, VISIT THE ZURN WEBSITE AT: www.zurn.com

SLOAN

URINAL ACCESSORIES





	ID ORDER#	MODEL#	DESCRIPTION
	453319	111 (3780000)	CLOSET FLUSH VALVE , manual, 1.6 gpf, polished chrome finish, top spud fixture connection, single flush (=Regal Pro #3640000)
	403246	111 (3010000)	CLOSET FLUSH VALVE—ROYAL , manual, 1.6 gpf, polished chrome finish, top spud fixture connection, single flush
	453355	111-XL (3080053)	CLOSET FLUSH VALVE—REGAL , manual, 1.6 gpf, XL sweat solder adapter kit, polished chrome finish, top spud fixture connection, single flush
	453699	110-XL (3080153)	Same as above, but 3.5 gpf
	454572	8111 (3250400)	CLOSET FLUSH VALVE—G2 OPTIMA PLUS , battery-powered, 1.6 gpf, G2 exposed sensor, polished chrome finish, top spud fixture connection, single flush
	454573	8186 (3250401)	Same as above, but 1.0 gpf
	706051	EBV500A (3325500)	RETROFIT SENSOR FLUSHOMETER—EXPOSED , for urinals and water closets, single-flush, side-mount, battery operated, polished chrome finish, fixture connection top spud
	453321	186 (3782624)	URINAL FLUSH VALVE—LOCKING VANDAL-RESISTANT STOPCAP , 1.0 gpf, ADA handle, locking vandal-resistant stop cap, sweat kit with cast set screw wall flange (=Regal Pro #3642600)
	453356	186-1XL (3082675)	URINAL FLUSH VALVE—REGAL , 1.0 gpf
	453797	186-XL (3082653)	Same as above, but 1.5 gpf
	453788	180-XL (3082453)	Same as above, but 3.5 gpf and with 1-1/4" top spud
	441293	WES150 (1001500)	URINAL CARTRIDGE—UNIVERSAL WATERFREE , for WES-1000 urinal

FOR ADDITIONAL INFORMATION, VISIT THE SLOAN WEBSITE AT: www.sloan.com

SLOAN FAUCETS & PARTS



	ID ORDER#	MODEL#	DESCRIPTION
	734568	SF2150-4-CP (3362102)	FAUCET— LOW BODY , battery-powered, deck-mounted, 0.5 gpm, 4" trim plate, sensor-activated, ADA compliant, adjustable infrared sensor range, back-check tee, below deck manual mixing valve, 36" sensor cable, 24" flex hose, filtered solenoid valve with serviceable strainer filter, includes (4) AA batteries, 1 year warranty
	509447	SF2350-CP (3362119)	FAUCET— MID-INTEGRATED BASE BODY , battery-powered, deck-mounted, 0.5 gpm, 4" CC, sensor-activated, ADA compliant, pedestal spout type, splash-proof circuit control module, adjustable infrared sensor range, back-check tee, below deck control access, manual and thermostatic mixing valves, 36" sensor cable, 24" flex hose, filtered solenoid valve with serviceable strainer filter, includes (4) AA batteries, 1 year warranty
	1737	H-535 (3308607)	ADAPTER , 3/4"
	1695	A-156-A (5301188)	DIAPHRAGM , for flush valve-type manual toilets
	1699	A-156-AA (5301189)	DIAPHRAGM REPAIR KIT WASHER SET
	1727	VBF-5 (5322001)	GASKET—SLIP-JOINT , 1-1/2"
	1709	B-32-A (5302279)	HANDLE ASSEMBLY—CHROME
	1708	B-50-A (5302305)	HANDLE REPAIR KIT
	1739	H-533-AS (3308780)	SUPPLY KIT , 1", includes adapter, casing tube and stamped wall flange
	1741	H-536-AS (3308786)	URINAL SUPPLY , 3/4", includes stamped wall flange
	1735	V-101-A (3322079)	VACUUM REPAIR KIT , for V100
	1730	V-551-A (3323192)	Same as above, but for V500A

FOR ADDITIONAL INFORMATION, VISIT THE SLOAN WEBSITE AT: www.sloan.com

FLUSHMATE

136093	C-100500-K	FLUSHMATE FLUSH VALVE CARTRIDGE
--------	------------	--

FOR ADDITIONAL INFORMATION, VISIT THE FLUSHMATE WEBSITE AT: www.flushmate.com



ID ORDER#	MODEL#	DESCRIPTION
34640 *	141-KC	DIAPHRAGM KIT, 1" , includes rubber diaphragm and auxilliary valve seat, for 1.6 gpf (=F141KC)
40243 *	141-KU	Same as above, but 3/4" (=F141KU)
1470 *	141-ACQ	INTERNAL REBUILD KIT—COMPLETE , includes Flushboy auxiliary valve, diaphragm bushing, auxiliary valve seat, auxiliary valve seat holder (2" O.D.), diaphragm, refill ring, seat guide, delrin seat and fibre washer, for use on all valves with 1" supply or larger and 4.5 gpf toilets (=F141ACQ)
1471 *	141-1-AU	Same as above, but used on all valves with 3/4" supply or smaller and 1.0 gpf toilets (=F141-1AU)
1472 *	333A	RUBBERFLEX HANDLE ASSEMBLY , for all models (=F333A)
1477 *	427A	RUBBER SLEEVE WITH METAL INSERT , for #50VB vacuum breakers (=P427A)
1480 *	50VB-3-9	VACUUM BREAKER ASSEMBLY , 1-1/2" x 3/4" x 9", chrome plated, for urinal (=50)
1481 *	50VB-1-9	Same as above, but 1-1/2" 1-1/2" x 9" and for closet

* = SPECIAL ORDER ITEM

VALVES WITH 1" SUPPLY

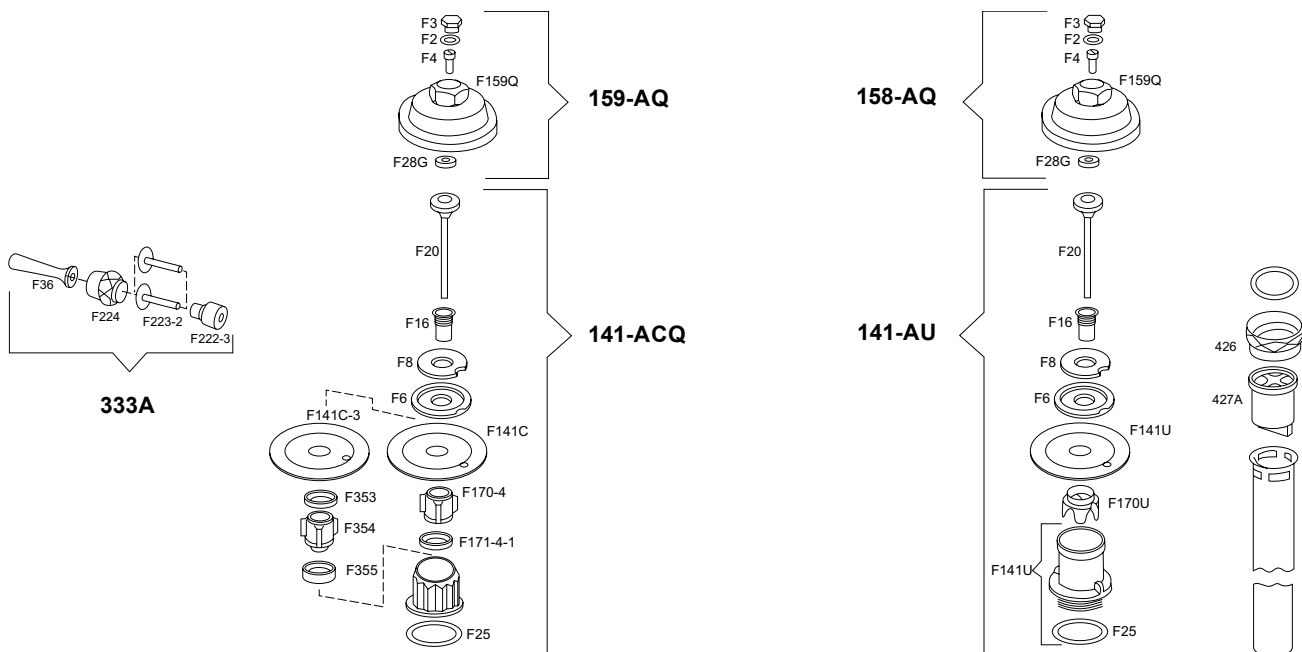

VALVES WITH 3/4" SUPPLY





FOR ADDITIONAL INFORMATION, VISIT THE DELANY WEBSITE AT www.delanyproducts.com

PENTAIR (AMERICAN PLUMBER) FILTERS









	ID ORDER#	MODEL#	DESCRIPTION
	10814	W5CIP (155002-52)	CHARCOAL FILTER , 5 micron, package of 2
	10815	W20CLA (155001-52)	SEDIMENT FILTER , 20 micron, 10", package of 2
	124828	WVC-34 (152003)	WATER FILTER—COMPLETE , includes clear housing screw kit, housing wrench and mounting bracket, 3/4" NPT inlet/outlet, valve-in-head, pressure relief button, <u>less cartridge</u>

ACCESSORIES

	74895	WW34 (152037)	SPANNER WRENCH , for 3/4" housing
	124830	W34-OR (152030)	REPLACEMENT O-RING , for 3/4" standard housing
	231798	WMB34 (152040)	WALL SUPPORT BRACKET , for WVC-34 water filter





FOR ADDITIONAL INFORMATION, VISIT THE PENTAIR WEBSITE AT www.pentair.com

	ID ORDER#	MODEL#	DESCRIPTION
OUTLET BOXES			
	672173	39156	ICE MAKER OUTLET BOX—<u>WITHOUT ARRESTER</u> , copper tailpiece, low lead, 1/4" valve, 6"W x 6"H x 3-3/8"D box dimensions
	247302	38552	QUADRO WASHING MACHINE OUTLET BOX—BRASS BOILER DRAIN , copper tailpiece, 2" drain opening fits PVC or ABS Schedule 40 DWV pipe, 3/4" valve, top or bottom valve mount, 8-3/4"W x 7-1/2"H x 3-5/8"D
	249420	38540	QUADRO WASHING MACHINE OUTLET BOX—COPPER TAILPIECE , brass boiler drain, 2" drain opening fits PVC or ABS Schedule 40 DWV pipe, 3/4" valve, top or bottom valve mount, 8-3/4"W x 7-1/2"H x 3-5/8"D
	452514	38542	Same as above, but <u>PEX tailpiece</u>
ACCESSORIES			
	38353	39012	INLINE VENT VALVE—ABS , 1-1/2" NPT, black
	725873	41601	SHOWER PAN LINER—PVC , 6' x 60', 40 mil, gray, sold per foot
	444953	34067	WASHING MACHINE PAN—PLASTIC , 28"W x 30H" x 2-1/2"D, pinched out for a furnished 1" PVC fitting





FOR ADDITIONAL INFORMATION, VISIT THE OATEY WEBSITE AT www.oatey.com

SIOUX CHIEF

OUTLET BOXES, ACCESS PANELS and ACCESSORIES

ID ORDER#	MODEL#	DESCRIPTION
OUTLET BOXES		
	742350 696-1020GF	OXBOX GAS OUTLET BOX , for CSST, 1/2" FIP
	741915 696-G1010MF	OXBOX ICEMAKER OUTLET BOX , lead-free, with hammer arresters and 1/2" female sweat
	741914 696-G1010XF	<i>Same as above</i> , but with hammer arresters and 1/2" PEX
	745507 696-G3011XR	OXBOX KITCHEN SUPPLY OUTLET BOX , with (2) 3/8" hot outlets, (1) 3/8" cold outlet, hot-side arrester and PEX connection
	743782 250-696122P	OXBOX LOUVERED KIT , with turbovent air admittance valve and 1-1/2"/2" adapter
	738305 696-G2313MF	OXBOX WASHING MACHINE OUTLET BOX , lead-free, with hammer arresters and 1/2" female copper for split stud pocket oxbox
	741913 696-G2313XF	<i>Same as above</i> , but with 1/2" PEX
ACCESS PANELS		
	745513 698-A11-XR	OMNI ACCESS PANEL—DUAL VALVE , 1/2" F1807 PEX outlet x 3/8" OD compression outlet
ACCESSORIES		
	745522 698-EX	ACCESS PANEL EXTENSION , for Omni access panel
	745514 698-F	ACCESS PANEL FRAME , for Omni access panel
	743757 250-122PB	AIR ADMITTANCE VALVE—TURBOVENT
	745516 696-1F	OXBOX FRAME , for single frame oxbox
	745520 696-EX	OXBOX EXTENSION

FOR ADDITIONAL INFORMATION, VISIT THE SIOUX CHIEF WEBSITE AT www.siouxchief.com

	ID ORDER#	MODEL#	DESCRIPTION
FLUIDMASTER LINE #1650			
	2178	400A	ADJUSTABLE ANTI-SIPHON FILL VALVE—UNIVERSAL , adjusts from 9" to 14"
	725945	PRO45B	ADJUSTABLE ANTI-SIPHON FILL VALVE WITH BRASS SHANK , adjusts from 9" to 14"
	726838	PRO55	FLEXIBLE FLAPPER—UNIVERSAL ADJUSTABLE , 1.6 gpf, fits most 2" valves with or without mounting ears, built-in Microban
	2692	242	REPLACEMENT SEAL , for all 200, 400 and 747 fill valves
	2691	555CRP8	FLUSH VALVE KIT , includes PerforMAX adjustable flapper
JONES-STEPHENS LINE #0910			
	40347	D45-000	BEEHIVE URINAL STRAINER , cast brass, chrome plated, brass locknut 2" caulk connection
KORKY PLUS LINE #1792			
	74813	2001BP	UNIVERSAL TANK FLAPPER , (=Jones #C04-016)
LEGEND LINE #0380			
	215566	T-20A	ANTI-CONDENSATION VALVE , 1/2", brass, built-in check valve, adjustable water temperature, hot water shut-off, 3-1/2" nominal compression nuts and ferrules, consists of (1) #111-154 1/2" IPS valve plus (1) #111-158 1/2" fittings set

STIEBEL ELTRON TOUCHLESS HAND DRYERS

STIEBEL ELTRON



ID ORDER#	MODEL#	DESCRIPTION
769683	073009	GALAXY 1 TOUCHLESS HAND DRYER , ultra quiet, fast dry time, 120V, 1850 watts, 9-1/16"W x 9-1/16"D x 9-7/8"H
769684	073010	GALAXY 2 TOUCHLESS HAND DRYER , ultra quiet, fast dry time, 240/208V, 2000/1500 watts, 9-1/16"W x 9-1/16"D x 9-7/8"H

FOR ADDITIONAL INFORMATION, VISIT THE
STIEBEL ELTRON WEBSITE AT www.stiebel-eltron-usa.com



300 SECTION

Chemicals — Solders

300 SECTION INDEX

Chemique	308
Diversitech	306
Freon	see 500 section
Hardcast	see 500 section
Hercules	302-302.2
Jomar	305
Lucas-Milhaupt	see 500 section
Mill-Rose Company	300 (also see 700 section)
Noble	304
Oatey	301-301.2 (also see 100, 400 and 700 sections)
Radiator Specialty	306
Rectorseal	307-307.1 (also see 500 section)
Rhomar	303-303.1
Rustbuster	see 500 section
Sealants	306
John M. Winslow	306







	ID ORDER#	MODEL#	DESCRIPTION	CTN QTY
	771457	71023	BLUE MONSTER MICROBUBBLE LEAK DETECTOR—WITH DAUBER , 8 ounces, non-freezing, usable from -10°F to 215°F, will not cause corrosion or deterioration of metal or plastic piping systems, ideal for testing pressures less than 1 psi	24
	771458	71027	<i>Same as above</i> , but <u>1 quart and with sprayer</u>	12
	771456	77095	BLUE MONSTER SCRUBBING TOWELS—CITRUS , 10"x12" dual-textured towels, pre-moistened (no water required), quick drying, non-rinsing, citrus cleanser with Vitamin E, aloe, and lanolin for conditioning, 75 count	20
	771452	76011	BLUE MONSTER THREAD SEALANT , 1/2 pint, heavy duty industrial grade, -50°F to 400°F temperature range, specially formulated for production line use, adheres to oily threads, non-hardening, non-toxic, slow-drying, soft set, grit free, low odor, easy cleanup	24
	771455	76015	<i>Same as above</i> , but 1 pint (16 oz.)	12

FOR ADDITIONAL INFORMATION, VISIT THE MILL-ROSE
WEBSITE AT www.blumonsterproducts.com

OATEY CEMENT & PRIMER



	ID ORDER#	MODEL#	SIZE	DESCRIPTION	CTN QTY
CEMENT					
	1447	31017	4 oz.	CEMENT , PVC medium, for pipe and fittings up to 6", 40-90°F range, includes applicator brush, NSF APPROVED	24
	1448	31019	16 oz.	Same as above	24
	1449	31020	32 oz.	Same as above	12
	122225	31128	4 oz.	CEMENT , CPVC medium, for pipe and fittings up to 6", 40-90°F range, includes applicator brush, orange, NSF APPROVED	24
	30512	31132	16 oz.	CLEAR ALL-WEATHER CEMENT , for fittings up to 6", 10-90°F range, includes application brush, NSF APPROVED	24
	30513	31133	32 oz.	Same as above	12
	193059	31008	32 oz.	Same as above, but heavy-duty, for fittings up to 12"	12
	624389	30834	16 oz.	CEMENT, ALL PURPOSE , 40°F-110°F range, medium-bodied milky clear, for ABS, PVC or CPVC up to 6" diameter, for Schedule 40/80/potable water/DWV, MEETS ASTM D-3564, D-2235 and F49.3	24
	653897	30876	16 oz.	CEMENT, HEAVY DUTY , 40°F-110°F range, heavy-bodied clear, for use on all schedules and classes of PVC pipe and fittings up to 12" with interference fit, 18" for DWV applications, for potable water/pressure pipe/conduit/DWV applications, MEETS ASTM D-2564 and NSF Standard 61	24
PRIMER					
	12275	30752	16 oz.	PRIMER , all-purpose, CLEAR, for PVC and CPVC cleaning, includes applicator, NSF APPROVED	24
	12276	30753	32 oz.	Same as above	12
	1444	30757	16 oz.	PRIMER , all-purpose, PURPLE, for PVC and CPVC cleaning, includes applicator, NSF APPROVED	24
	1445	30758	32 oz.	Same as above	12





FOR ADDITIONAL INFORMATION, VISIT THE OATEY WEBSITE AT www.oatey.com

OATEY

FLASHINGS - WAX RINGS - FLANGES



CTN
QTY

	ID ORDER#	MODEL#	SIZE	DESCRIPTION	
ROOF FLASHINGS & REPAIR COLLARS					* = SPECIAL ORDER ITEM
	1430 *	11830	1/2", 3/4", 1"	ROOF FLASHING , galvanized, no-caulk	12
	1431	11840	1-1/4", 1-1/2"	ROOF FLASHING , neoprene collar and galvanized base, no-caulk	12
	1432	11853	2"	<i>Same as above</i>	12
	1433	11866	3"	<i>Same as above</i>	12
	42374	11879	4"	<i>Same as above</i>	12
	89089	11909	2"	ROOF FLASHING , thermal base, no-caulk	12
	24218	11910	3"	<i>Same as above</i>	12
	141678	11930	1-1/2"-3"	HIGH-RISE ROOF FLASHING , thermal base, 2/12-20/12 pitch, no caulk	6
	141681	11931	3-4"	<i>Same as above</i>	6
	86531	14052	1/4-4"	MASTER FLASH ROOF FLASHING , slides over pipe for pitch to 45°; molds to metal, plastic, etc.; non-fading EPDM collar; rated to 212°F continuous heat; approved for Type B installations; use silicone sealant between base and surface, secure with metal screws, 8" x 8" base	6
	126507	14053	3-6"	<i>Same as above</i> , but 10" x 10" base	6
	126512	14056	6-11"	<i>Same as above</i> , but 14" x 14" base	2
	1434	14135	2"	REPAIR COLLAR (RC-2) ONLY , no caulk	12
WAX BOWL RINGS					
	123101	31190	--	WAX BOWL RING , heavy-duty	48
	123102	31194	--	<i>Same as above</i> , but with polyethylene sleeve	24
	649153	31187	--	WAX URINAL RING	12
CLOSET FLANGES					
	74090	43501	3" or 4"	PVC OFFSET CLOSET FLANGE , with metal ring, allows 4-way offset of 2", fits over 3" or inside 4" Schedule 40 pipe	12
	193778	43507	3"	PVC CLOSET FLANGE , fits inside 3" PVC pipe, with knockout	12
	74894	43539	4"	PVC CLOSET FLANGE , cast iron, for 4" PVC or cast iron pipe	6

FOR ADDITIONAL INFORMATION, VISIT THE OATEY WEBSITE AT www.oatey.com

SEPTEMBER 2024



Line #2900

OATEY

SOLDER - FLUX - MISCELLANEOUS

301.2





	ID ORDER#	MODEL#	SIZE	DESCRIPTION	CTN QTY
SOLDER & FLUX					
	1441	20019	1 lb.	WIRE SOLDER , 50/50 spool	50
	28455	23001	1 lb.	WIRE SOLDER , LEAD FREE, spool	25
	17385	30372	8 oz.	FLUX , #95 LEAD FREE	24
	1442	30013	4 oz.	Same as above, but #5 paste	24
	1443	30041	1 lb.	Same as above	12
MISCELLANEOUS					
	80953	30209	8 oz.	LEAK DETECTOR , all-purpose with dauber	24
	1457	30236	10.3 oz.	100% SILICONE CAULK , rated -60°F to 400°F	12
	38353	39012	1-1/2"	IN-LINE VENT VALVE , ABS	6

FOR ADDITIONAL INFORMATION, VISIT THE OATEY WEBSITE AT www.oatey.com



HERCULES CLEANERS & SEALANTS



ID ORDER#	MODEL#	SIZE	DESCRIPTION	CTN QTY
1020	30213	12 oz.	BASE-HIT , sealer for hydronic systems, non-clogging to vents, valves, etc., product left in system	12
 1017	30115	1 qt.	BOILER LIQUID , used for sealing a cracked or leaking boiler, effective but must be used per directions, one quart per 850 feet of boiler rating, call for exact specifications	12
1023	35206	1 qt.	BOILER SYSTEM CLEANER , intended for use in a hydronic boiler and system, emulsifies oil and grease, prevents rust and does not have to be drained	12
 998	20205	1 qt.	CLOBBER PROFESSIONAL (†) , lime & scale remover; contains sulfuric acid—keep away from children; read all instructions; NOT FOR RESALE. May be shipped UPS but not by mail. FOR PROFESSIONAL USE ONLY.	12
1000	20211	1/2 gal.	Same as above, but 1/2 gallon	6

WARNING (†) CLOBBER CONTAINS SULFURIC ACID WHICH CAN BURN SKIN, EYES AND CLOTHING!



Keep away from children. NEVER lift container by its cap. Read instructions on warning label before transporting. **CLOBBER™ SHOULD ONLY BE USED BY PROFESSIONALS.** This product can be shipped by UPS but not through the mail.

 1029	40115	1 qt.	CUTTING OIL — CLEAR , oil and sulphur based oil intended for hand threading applications	12
1031	40120	1 gal.	Same as above, but 1 gallon size	6
1032	40215	1 qt.	CUTTING OIL— DARK , sulphur-lard based oil intended for high speed machine threading	12
1033	40220	1 gal.	Same as above, but 1 gallon size	6
 1015	25410	1 gal.	FLASHING CEMENT , adheres to wet or moist surfaces and remains flexible, can be used for roof, curb or flashing, apply with putty knife or trowel	6
32557	35515	1/2 gal.	FURNACE CEMENT , this non-asbestos product is rated up to 3000°F and will not crumble when dry	6
 217166	20455	1/2 gal.	GLUG BATHROOM DRAIN CLEANER , non-acid, liquid, specifically formulated for tubs, bathroom and shower drains	6
217167	20475	1/2 gal.	Same as above, but kitchen drain cleaner, specifically formulate to clear and clean clogs from fats, grease and foodstuffs	6

FOR ADDITIONAL INFORMATION, VISIT THE OATEY WEBSITE AT www.oatey.com

HERCULES CLEANERS & SEALANTS





ID ORDER#	MODEL#	SIZE	DESCRIPTION	CTN QTY
1039	90124	5/16" dia.	JOHNI-BOLT , 2-1/4" closet bowl setting kit, includes two brass bolts, washers and cap nuts per kit	100
120016	90174	5/16" dia.	<i>Same as above</i> , but 3-1/2"	100
	446542	90214	3" - 4" JOHNI-RING , wax closet bowl setting gasket (Use Oatey #31190, ID #123101)	48
92559	90241	3" - 4"	"JUMBO" JOHNI-RING , extra thick wax gasket with plastic horn	24
11966	25605	6 oz.	PLUMBER'S CAULK — SQUEEZE TUBE , white, acrylic latex with silicone, remains flexible and can be painted. For best results, apply at 50°F or above (=Boss #36251)	24
31999	25631	5.5 oz.	<i>Same as above</i> , but almond/bone color (=Boss #36255)	24
46687	25615	11 oz.	PLUMBER'S CAULK — CARTRIDGE , white, acrylic latex with silicone, remains flexible and can be painted. For best results, apply at 50°F or above (=Boss #36301)	12
46691	25636	10.3 oz.	<i>Same as above</i> , but almond/bone color (=Boss #36305)	12
	994	15420	1/2 pt. PRO-DOPE , with brush applicator, also suited for water, steam (not for use on LP gas), natural gas, and mild acids and alkalis, gray color	24
995 *	15433	6 lb.	<i>Same as above</i> , but with plastic pail with handle	6

* = SPECIAL ORDER ITEM

FOR ADDITIONAL INFORMATION, VISIT THE OATEY WEBSITE AT www.oatey.com

HERCULES CLEANERS & SEALANTS



ID ORDER#	MODEL#	SIZE	DESCRIPTION	CTN QTY
1006	20602	2 lb.	R-D ROOT DESTROYER	6
	1021	35100	113 gram SCOUT BOILER CLEANER , especially used on steam boilers to prevent surging	12
2769	25666	10.1 oz.	SILICONE SEALANT , red RTV high-temp, -80°F to 600°F	12
1456	25676	10.1 oz.	SILICONE SEALANT , white, mildew resistant (=Dow #786)	12
	1002	20305	1 qt. SIZZLE , lime, rust and scale remover, professional use only, not for resale	12
1005	20310	1 gal.	Same as above, but 1 gallon	4
1026	35427	85 gram	SOOT DESTROYER , flip stick, an easy and effective way to remove soot, intended for all fuels but used primarily on oil	72
	1009	25101	14 oz. STA-PUT , non-staining, non-hardening, plastic putty, ideal for use in setting bowls, fixtures, rims and other caulking applications	24
1011	25103	3 lb.	Same as above, but 3 lb. container	12
997	20110	1 qt.	WHAM , drain cleaner, clears grease clogged drains and traps	12

FOR ADDITIONAL INFORMATION, VISIT THE OATEY WEBSITE AT www.oatey.com

RHOMAR ANTIFREEZE & ACCESSORIES



- Aluminum safe
- Multi-metal (aluminum, brass, cast iron, copper, steel)
- Non-hazardous (†)
- For all types of hydronic heating and cooling systems
- Freeze, corrosion and scale protection
- Freeze protection to -60°F; burst protection to -100°F
- Approved by major boiler manufacturers



ID ORDER#	MODEL#	DESCRIPTION
600818	RHOGARD	RHOGARD ANTIFREEZE , virgin propylene glycol with Pro-Tek corrosion and scale inhibitor additives, 5 gallon pail, gosselin toxicity index=1
600819	9100	HYDRO-SOLV CLEANER , 1 gallon, cleans aluminum, brass, copper, iron, and steel; safe on all hydronic system components; contains no acids or TSP (trisodium phosphate)
600820	922	PRO-TEK BOILER TREATMENT (INHIBITOR) , 1 gallon, compatible with all brands of glycol antifreeze (NOTE: Rhomar recommends adding additional Pro-Tek when less than a 50% solution of RhoGard antifreeze is added to a system)
600822	HI98127	pH METER , with cap and batteries, calibrated and ready-to-use, dual level LCD, battery level indicator, replaceable pH electrode cartridge, instability indicator, automatic calibration and shut-off, floating waterproof casing, 6.4" x 1.6" x 1.0"
600821	HI98304	CONDUCTIVITY METER , with automatic temperature compensation; used to measure the amount of dissolved impurities in the makeup or fill water and/or check the amount of additives in the boiler water fluid
600823	RF-40	GLYCOL TESTER (REFRACTOMETER) , measures glycol concentration, easy-to-read scale, automatic temperature compensation; requires only 2 to 3 drops of solution; simple focus adjustment; 6.5" x 1.5" x 1/5"; range: -60°F to 32°F propylene and ethylene glycol freeze point; resolution: 10°F glycol freeze point

FOR FREEZE PROTECTION AND WATER CAPACITY CHARTS, SEE PAGE 303.1

FOR ADDITIONAL INFORMATION, VISIT THE RHOMAR WEBSITE AT www.rhomarwater.com

RHOMAR CALIBRATION FLUID



ID ORDER#	MODEL#	DESCRIPTION
600856	HI7007M	pH7.01 CALIBRATION (BUFFER) FLUID , 230 ml, for pH meter #HI98127 (both pH7.01 and pH10.01 required)
600857	HI7010M	pH10.01 CALIBRATION (BUFFER) FLUID , 230 ml, for pH meter #HI98127 (both pH7.01 and pH10.01 required)
600854	HI7031M	CONDUCTIVITY CALIBRATION FLUID , 230 ml, for conductivity meter #HI98304

RHOGARD FREEZE PROTECTION CHART			
Rhogard %	Freeze Point	Fluid Flow	Burst Protection
100%	-60°F	-70°F	-100°F
75%	-25°F	-40°F	-70°F
60%	0°F	-15°F	-55°F
50%	+5°F	-10°F	-50°F
40%	+12°F	0°F	-10°F

Note: RhoGard Ultra and RhoGard RTU will have different freeze charts.
Freeze protection figures may vary slightly due to water chemistry. Flow and burst figures are estimates that will be affected by system design and components.

WATER CAPACITIES OF COPPER TUBES						
Tube Size	1/4"	3/8"	1/2"	5/8"	1"	1-1/4"
Gallon/Ft.						
Type K	.004	.006	.011	.023	.040	.063
Type L	.004	.006	.012	.025	.044	.065
Tube Size	1-1/2	2	2-1/2	3	4	5
Gallon/Ft.						
Type K	.089	.157	.242	.345	.607	.940
Type L	.092	.161	.247	.354	.623	.971

WATER CAPACITY PER FOOT OF SCHEDULE 40 BLACK PIPE												
Pipe Size	1/2"	3/4"	1"	1-1/4"	1-1/2"	2"	2-1/2"	3"	3-1/2"	4"	5"	6"
Gallons Per Foot	.016	.023	.040	.063	.102	.17	.275	.39	.53	.69	1.1	1.5

FOR ADDITIONAL INFORMATION, VISIT THE RHOMAR WEBSITE AT www.rhomarwater.com

NOBLE ANTIFREEZE



ID ORDER#	MODEL#	SIZE	DESCRIPTION	CTN QTY
--------------	--------	------	-------------	------------

34283	755	5 gal.	NOBURST STATE-APPROVED NON-TOXIC PROPYLENE GLYCOL , for hydronic heating and solar applications, concentrated, stocked in either red or blue mix depending on market conditions, colors can be mixed, see below for mixing proportions; Gosselin toxicity index = 1 (NOTE: 55 gallon drums available upon request.)	24
-------	-----	--------	--	----

IMPORTANT!
Do not use on any boiler with an aluminum block.

Mixing Proportions: 100% - 100° F 50% - 50° F

ACCESSORIES

10251	770	16 oz.	SYSTEM PRECLEANER , removes rust and corrosion from new and old systems	9
10252	775	16 oz.	RUST INHIBITOR , regenerates corrosion inhibitors	9
72732	782	--	ANTIFREEZE TEST KIT , includes 10 strips and chart in bottle	12



WATER CAPACITIES OF COPPER TUBES						
Tube Size	1/4"	3/8"	1/2"	5/8"	1"	1-1/4"
Gallon/Ft. Type K	.004	.006	.011	.023	.040	.063
Type L	.004	.006	.012	.025	.044	.065
Tube Size	1-1/2	2	2-1/2	3	4	5
Gallon/Ft. Type K	.089	.157	.242	.345	.607	.940
Type L	.092	.161	.247	.354	.623	.971

WATER CAPACITY PER FOOT OF SCHEDULE 40 BLACK PIPE												
Pipe Size	1/2"	3/4"	1"	1-1/4"	1-1/2"	2"	2-1/2"	3"	3-1/2"	4"	5"	6"
Gallons Per Foot	.016	.023	.040	.063	.102	.17	.275	.39	.53	.69	1.1	1.5

FOR ADDITIONAL INFORMATION, VISIT THE NOBLE WEBSITE AT www.noblecompany.com



JOMAR SEALING COMPOUND



	ID ORDER#	MODEL#	SIZE	DESCRIPTION	CTN QTY
	1451	400-002	1/4 pt.	TEFLON THREAD SEALING COMPOUND , Gimme the White Stuff, all-purpose, slow drying, soft setting, -50° to +400° temperature range, in brush-top can, may be used on metal, plastic, PVC, ABS, CPVC and nylon threads, do not use on oxygen	24
	1452	400-003	1/2 pt.	<i>Same as above</i>	24
	1453	400-004	1 pt.	<i>Same as above</i>	12
	39114	400-104	1 pt.	PIPE THREAD COMPOUND, LEAD FREE , Gimme the Green Stuff, slow drying, soft setting, non-hardening and non-toxic, won't harden in the can or freeze in your truck, temperature ranges from -50° to 400°F, for all metal, PVC, CPVC, nylon or polypropylene threads	12

FOR ADDITIONAL INFORMATION, VISIT THE JOMAR WEBSITE AT www.jomarvalve.com

SEALANTS, SMOKE CANDLES & GASKETS

ID	ORDER#	MODEL#	SIZE	DESCRIPTION	CTN	QTY
SEALANTS LINE 2900/2905/2930/2990						
	85328	5111 (SSC-C)	10.3 oz.	DURODYNE SILICONE SEALANT , clear, multi-purpose, -76°F to 350°F, approved for use on stainless steel venting on Weil McLain GV boilers (=Boss #31200 and Dow #315), VOC compliant	12	
	655117	5112 (SSA-C)	10.3 oz.	Same as above, but aluminum color, range is -60°F to 400°F; does not meet UL-181 (=Boss #37003)	12	
	80642	7000RTV (GE RTV106)	2.8 oz.	G.E. SILICONE SEALANT , squeeze tube, used to seal all joints in condensing or positive pressure systems, for furnace venting with stainless steel, rated for up to 550°F	6	
	1456	25676	10.3 oz.	HERCULES SILICONE SEALANT , white cartridge-type tube caulk, mildew resistant, -60°F to +450°F range (=Hercules #25676, Boss #38501 and Dow #786)	12	
	1457	30236	10.3 oz.	Same as above, but clear and -60°F to +400°F (=Oatey #30236, Boss #39900 and Dow #999A)	12	
	1457	30236	10.3 oz.	OATEY 100% SILICONE CAULK , rated -60°F to 400°F	12	
	2769	25666	10.15 oz.	RED HIGH-TEMP RTV SILICONE SEALANT , cartridge type, rated for up to 600°F (=Hercules #25666, Loctite #59675 and Boss #37610)	6	
	RADIATOR SPECIALTY LINE #3000					
	10250	B1-67	20 oz	BOILER SEAL , non-metallic powdered leak sealant, best when mixed with hot water and injected into boiler, use one can for each 1500 sq. ft. of steam radiation and water boilers and one can for each 1000 sq. ft. of radiation	12	
SMOKE CANDLES (Diversitech) LINE #5605						
	170828	14145	45 second	"SMOKEY'S" SMOKE CANDLES , burns for 45 seconds, makes 150 cubic feet of smoke, sold by package of 10 only; smoke emitter cartridges provide effective, low cost leak testing of heat exchangers, air ducts, tanks and boilers; visual air balancing of HVAC systems; cartridges produce clean, non-toxic, oil-free smoke through chemical reaction; use also for fire drills as well as the placement and testing of smoke alarms/detector	10	
JOHN M. WINSLOW LINE #5780						
	10257	3639	--	GASKET MATERIAL , all purpose 12" x 40" x 1/16" sheets made of non-asbestos fiber and Nitrile-Butadiene binder, ideal for fuel oil, gasoline, grease, kerosene, propane propylene glycol, steam and water applications	12	



ID ORDER#	MODEL#	SIZE	DESCRIPTION	CTN QTY
--------------	--------	------	-------------	------------

PLUMBING & HEATING PRODUCTS



744659	68711	--	CALCI-FREE TANKLESS WATER HEATER FLUSH KIT , contains (1) heavy-duty, chemical-resistant, submersible utility pump with 3/4" GHT connection; (1) 7' feeder hose with swivel fittings; (1) 7' discharge hose; (1) elevated pump strainer/grate; and (1) 1.2 lbs Calci-Free NOTE: DO NOT USE ON ALUMINUM	1
--------	-------	----	--	---

744660	68708	1.2 lbs.	CALCI-FREE CLEANER , used on tankless water heaters; fast acting, biodegradable, cleans circulations coils, restores water flow and pressure NOTE: DO NOT USE ON ALUMINUM	12
--------	-------	----------	---	----



178623	66640	10.3 oz.	METACAULK 1000 FIRESTOPPING SEALANT , will expand when exposed to fire or heat; water based—no mixing necessary; 10.3 oz. cartridge; red color; rated up to 3 hours in accordance with ASTM E-814 and UL1479, up to 2 hours with UL2079; MAY SHIP BY UPS.	12
--------	-------	----------	---	----

445600	68514	2 lbs.	ODORGON POWDER , eliminates odors and absorbs oil from concrete and other floors; non-explosive, non-flammable; sifter top for controlled usage and clean storage	12
--------	-------	--------	--	----

A/C PRODUCTS

740766	45318	--	A/C LEAK FREEZE UV PRO , 1.46 oz.	12
--------	-------	----	--	----



737695	82560	--	DESOLV MINI-SPLIT CLEANING KIT , with (1) gallon Desolv solution, (2) single-use funnel bags, (1) cleaning brush, (1) 5-gallon drain pail, and (1) C-band frame assembly	1
--------	-------	----	---	---

737697	82566	--	DESOLV NON-CORROSIVE COIL CLEANER , <u>1 gallon</u> , biodegradable, low toxicity, acts as a corrosion inhibitor	4
--------	-------	----	---	---

737698	82561	--	<i>Same as above</i> , but <u>16 oz. aerosol can</u>	12
--------	-------	----	--	----

737696	82562	--	DESOLV SINGLE-USE FUNNEL BAG , 10/pkg	1
--------	-------	----	--	---



756298	97221	1/4"	FLARETITE SEAL , 10/pkg	1
--------	-------	------	--------------------------------	---

756297	97220	3/8"	<i>Same as above</i>	1
--------	-------	------	----------------------	---

756296	97219	1/2"	<i>Same as above</i>	1
--------	-------	------	----------------------	---

756507	97218	5/8"	<i>Same as above</i>	1
--------	-------	------	----------------------	---

**FOR ADDITIONAL INFORMATION, VISIT THE
RECTORSEAL WEBSITE AT www.rectorseal.com**





ID ORDER#	MODEL#	SIZE	DESCRIPTION	CTN QTY
A/C PRODUCTS				
718265	97632	--	SS1 SAFE-T SWITCH , for installation on primary drains or auxiliary drain outlets, includes 3/4" adapter, bushing and cap, can be installed horizontally or vertically, inline or on the primary pan's auxiliary drain outlet by using the included adapter, bushing and cap, can be installed on a sloping line, does not need to be level or plumb	24
734241	97637	--	SS2 SAFE-T SWITCH , for installation on primary pan auxiliary outlets, includes 3/4" adapter, can be installed on the auxiliary outlet of the primary drain pan, provides easy access to the switch and the primary drain line for service	24
747818	96415	--	SURGE PROTECTION DEVICE (RSH-50) , 50 kA	6
713125	82500	--	TURBO-KLEEN A/C SYSTEM FLUSH KIT , includes injector nozzle and canister, flushing tool, plastic connecting line, and 1 pint of Turbo-Kleen chemical solution (=Diversitech #PF-KIT)	6
713309	82400	--	TURBO-KLEEN A/C SYSTEM FLUSH REFILL , 16 oz. (=Diversitech #PF-16)	12
744847	82642	--	ZIPP CLEANER AND DEGREASER , 14 oz. aerosol, non-flammable, non-conducive, fast drying, leaves no residue	12

FOR ADDITIONAL INFORMATION, VISIT THE
RECTORSEAL WEBSITE AT www.rectorseal.com

RECTORSEAL A/C COIL CLEANERS



ID ORDER#	MODEL#	SIZE	DESCRIPTION	CTN QTY
 214576 *	45004	4 oz.	ACID-AWAY compressor burnout acid neutralizer, 4 oz., for use in air conditioning and refrigeration systems that have experienced a burnout or operating systems that are showing a buildup in acid content; circulates quickly throughout system and chemically neutralizes acids that are always left in an air conditioning or refrigeration system after a burnout; once neutralized, this acid can no longer continue its corrosive attack and cause another burnout; MAY SHIP BY UPS	12
 173049	82612	1 gallon	COIL-RITE CLEANER , a non-acid, self-rinsing cleaner and degreaser for evaporator and condenser coils, air conditioning and air handling equipment, electronic and permanent air filters; lifts grime and oil from normally inaccessible places; MAY SHIP BY UPS	4
 732613	82632	1 gallon	FOAM-A-COIL CLEANER , a non-acid, biodegradable cleaner and degreaser for evaporator and condenser coils, air conditioning, and air handling equipment, electronic and permanent air filters; available in aerosol for window units, ice machines and small refrigerated equipment; adhering foam lifts grime and oil from normally inaccessible places; non-flammable; environmentally responsible	4
 173050	88438	20 oz.	K. O. DIRT BLASTER , a high-pressure cleaner and degreaser for small condenser coils found in restaurant and food service refrigeration, air conditioners, electrical and mechanical equipment; strips off dirt and cooking grease without a water rinse; quick-drying safety solvent with pleasant scent, high dielectric strength, non-flammable; HAZARDOUS—MAY NOT SHIP BY UPS, BUS OR PARCEL POST	12
 173048	82644	1 gallon	RENEWZ CLEANER , a non-acid, high foaming cleaner and brightener for air cooled condenser coils; leaves aluminum bright, shiny and clean in less than 5 minutes; removes cooking grease; heavy foaming action floats all loosened material out of inaccessible areas; also cleans electronic air filters; HAZARDOUS—MAY NOT SHIP BY UPS, BUS OR PARCEL POST	4

* = SPECIAL ORDER ITEM

FOR ADDITIONAL INFORMATION, VISIT THE RECTORSEAL WEBSITE AT www.rectorseal.com

BATHROOM & WHIRLPOOL SYSTEM CLEANERS

ID ORDER#	MODEL#	DESCRIPTION	CTN QTY	
CHEMIQUE LINE #2925				
	154358	KRC-7	ORIGINAL FORMULA BATHROOM CLEANER , 16 ounce viscous liquid, used to remove soap scum, hard water stains, mineral deposits, rust, mildew, algae and oxidation from glazes and unglazed REAL ceramic tile, fiberglass, shower stalls, grouting, non-slip tubs, whirlpools, sinks, commodes, urinals, chrome fixtures, stainless, glass, aluminum, brass, copper, painted surfaces and exhaust fans, can be used with septic systems	24
	154359	KRC-7	Same as above, but 32 ounce	12
	621832	KRC-7	ULTRA FOAMING BATHROOM CLEANER , same uses as above but 32 ounce high foaming trigger spray formula, for all name brand fixtures, can be used with septic systems	12
	154361	--	WHIRLAWAY WHIRLPOOL & SPA PLUMBING SYSTEM CLEANER AND DEODORIZER , 8 oz. powder, solubilizes and/or emulsifies contaminants such as soap scum, bath oils, body oils, mold, mildew, algae, mineral deposits, and dirt accumulations that produce infectious bacteria and sulfides that produce objectionable odors, environmentally safe and 100% biodegradable	24

FOR ADDITIONAL INFORMATION, VISIT THE CHEMIQUE WEBSITE AT www.chemique.com

400 SECTION

Boilers — Water Heaters

400 SECTION INDEX

Amtrol	417-417.3 (also see 700 section)	Stiebel Eltron	402
Beacon/Morris	412	Taco	414-414.7
Bell & Gossett	413-413.1	Tekmar	409
Boshart	418	Uponor (Wirsbo)	406-406.6
Conbraco (Apollo/APC)	424-424.2	Webstone	415-415.2
Danfoss	425	Weil-McLain	403-403.23
Dielectric Unions	see 100 Section	Weiss	419
Gauges & Thermometers	420	Westwood	420
Grundfos	416-416.7	Wilkins	427-427.1
Hoffman	422		
Hydrolevel	426-426.1		
Hydronic Accessories	421		
Lochinvar	404-404.7		
McDonnell & Miller	423		
Modine	411		
Oatey	429 (also see 100, 300 and 700 sections)		
Red & White Valve Corp.	408		
Rehau	407-407.9		
Rheem	400-400.8		
Rinnai	405-405.9 (also see 500 section)		
Slant/Fin	410-410.2		
A.O. Smith	401-401.11		
Sparco	420, 428-428.1		

RHEEM CONDENSING TANKLESS GAS WATER HEATERS



- Continuous flow
- Up to .93 UEF with stainless steel condensing heat exchanger
- Indoor direct vent with 2" venting connections
- Vent up to 150' with 3" PVC and 60' with 2" PVC
- Built-in condensate neutralizer
- 1/2" gas line compatibility up to 24'
- Self-diagnostic system
- Pre-wired digital remote control with 10' of thermostat wire
- Requires 120V power supply
- Low flow activation at minimum flow rate of .26 GPM and minimum activation flow rate of .40 GPM
- Recirculation pump kit-ready
- Hot start programming
- EcoNet enabled
- Ultra low NOx burner meets SCAQMD rule 1146.2 requirements
- Overheat film wrap
- Freeze protection to -30°F



NOTE:
May require a T&P valve. Check with your local inspector before installation.

RESIDENTIAL WARRANTY

- 12 year limited heat exchanger, 5 year limited parts, 1 year labor

COMMERCIAL WARRANTY

- 5 year limited heat exchanger, 5 year limited parts, 1 year labor

ID ORDER#	MODEL#	FUEL	UEF (†)	GAS INPUT MBTU/H	TEMP. RANGE	VENT SIZE	DIMENSIONS WITH VENT CONN. W x D x H (††)
-----------	--------	------	---------	------------------	-------------	-----------	---

PRESTIGE CONDENSING TANKLESS

726927	RTGH-95DVLN-2	NG	0.93	11.0-199.9	85°F-140°F	2" or 3" PVC pipe (2)	18-1/2" x 9-3/4" x 29-1/4"
733041	RTGH-95DVLP-2	LP	0.93	11.0-199.9	85°F-140°F	2" or 3" PVC pipe (2)	18-1/2" x 9-3/4" x 29-1/4"

ACCESSORIES

668732	RTG20240A	COMMERCIAL CONVERSION KIT , for the RTGH-95DVLN, 85°F-185°F
668733	RTG20240B	Same as above, but for the RTGH-95DVLP
249100	TP1100AE-3C-150C	T&P VALVE (WILKINS) , 3/4"M x 3/4"F
669429	H-54443W	LEAD-FREE PIPING KIT (WEBSTONE) , FIP union x sweat

MODEL	MIN. FLOW/ACTIVATION GPM	GPM @ 67 RISE MAX.	GPM @ 45 RISE MAX.	MAXIMUM GPM	WATER CONN.	GAS CONN.
RTGH-95DVLN-2	0.26/0.40	5.7	8.5	9.5	3/4"	3/4"
RTGH-95DVLP-2	0.26/0.40	5.7	8.5	9.5	3/4"	3/4"

FOR ADDITIONAL INFORMATION, VISIT THE RHEEM WEBSITE AT www.rheem.com

(†) UEF = Uniform Energy Factor (††) Height including vent connections

RHEEM ATMOSPHERIC VENT GAS WATER HEATERS



- 0.58 - 0.66 UEF
- Guardian System & Sensor air/fuel shut-off device disables the heater in the presence of flammable vapor accumulation
- Low NOx emissions
- Rheemglas tank lining
- Premium-grade anode rod
- Piezo ignitor—no matches required
- Enhanced flow brass drain valve
- T&P relief valve
- Low lead compliant
- Standard replacement parts

WARRANTY—PROFESSIONAL CLASSIC

- 6 year limited tank and parts (10 year limited tank warranty with ProtectionPlus), 1 year labor

WARRANTY—PROFESSIONAL CLASSIC PLUS

- 8 year limited tank and parts (12 year limited tank warranty with ProtectionPlus), 2 year labor



Professional Classic Atmospheric



Professional Classic Plus Atmospheric

ID ORDER#	MODEL#	FUEL	NOM. CAP.	BTUH IN/HR	RATED 1ST HOUR STOR. VOL.	1ST HOUR RATING (GAL.)	UEF (†)	RECOV. 90°F RISE (GPH)	VENT SIZE	DIMENSIONS H (††) x DIA
PROFESSIONAL CLASSIC ATMOSPHERIC — TALL MODELS										
696687	PROG29-32N-RH63	NG	29	32.0	28	63	0.60	32.3	3" or 4"	59-3/4" x 16-1/2"
696688	PROG40-38N-RH62	NG	40	38.0	38	64	0.58	38.4	3" or 4"	61-1/2" x 19-1/2"
696689	PROG50-38N-RH60	NG	50	38.0	48	85	0.64	38.4	3" or 4"	61-1/4" x 20-1/2"
697849	PROG29-30P-RH63	LP	29	30.0	28	63	0.60	30.3	3" or 4"	59-3/4" x 16-1/2"
697228	PROG40-36P-RH62	LP	40	36.0	38	84	0.66	36.3	3" or 4"	63-1/4" x 19-1/2"
697229	PROG50-36P-RH60	LP	50	36.0	48	85	0.64	36.4	3" or 4"	61-1/4" x 20-1/2"
PROFESSIONAL CLASSIC ATMOSPHERIC — SHORT MODELS										
697848	PROG30S-30N-RH63	NG	30	30.0	29	51	0.60	30.3	3" or 4"	49-7/8" x 19-3/4"
697227	PROG40S-38N-RH62	NG	40	38.0	39	65	0.58	38.4	3" or 4"	53-1/4" x 21-3/8"
697233	PROG40S-35P-RH62	LP	40	35.0	39	65	0.58	35.4	3" or 4"	53-1/4" x 21-3/8"
PROFESSIONAL CLASSIC PLUS ATMOSPHERIC — HEAVY DUTY MODELS										
<i>Includes side water connections for space heating applications</i>										
697846	PRO+G75-76N-RH	NG	75	75.1	73	100	0.61	72.8	4"	64" x 26-1/4"
697850	PRO+G75-76P-RH	LP	75	75.1	73	100	0.61	72.8	4"	64" x 26-1/4"

FOR ADDITIONAL INFORMATION, VISIT THE RHEEM WEBSITE AT www.rheem.com

(†) UEF = Uniform Energy Factor (††) Height to top of tank. Add for necessary vent clearances.

RHEEM POWER VENT GAS WATER HEATERS



- 0.61 - 0.69 UEF
- Electronic gas control self-diagnostic system
- Low NOx emissions
- Standard 120 VAC electrical connection
- Guardian System & Sensor air/fuel shut-off device disables the heater in the presence of flammable vapor accumulation
- Long venting lengths up to 100 equivalent feet
- PVC, ABS or CPVC vent pipe options
- Vertical or horizontal termination
- Premium-grade anode rod
- Enhanced flow brass drain valve
- T&P relief valve
- Low lead compliant
- Silicon nitride ignitor
- Standard replacement parts



**Professional Classic
Power Vent**



**Professional Classic Plus
Power Vent**

WARRANTY—PROFESSIONAL CLASSIC PV

- 6 year limited tank and parts (10 year limited tank warranty with ProtectionPlus), 1 year labor

WARRANTY—PROFESSIONAL CLASSIC PLUS PV

- 8 year limited tank and parts (12 year limited tank warranty with ProtectionPlus), 1 year labor

ID ORDER#	MODEL#	FUEL	NOM. CAP.	BTUH IN/HR	RATED 1ST HOUR STOR. VOL.	RATING (GAL.)	UEF (†)	RECOV. 90°F RISE (GPH)	VENT SIZE	DIMENSIONS H (††) x DIA
PROFESSIONAL CLASSIC POWER VENT — SHORT MODELS										
683995	PROG40S-36N-RH67-PV	NG	40	36.0	39	64	0.61	36.4	2" or 3"	62-1/2" x 21-3/4"
683987	PROG50S-36N-RH67-PV	NG	50	36.0	48	80	0.65	36.4	2" or 3"	62-1/2" x 23-3/4"
683997	PROG40S-32P-RH67-PV	LP	40	32.0	39	64	0.61	32.4	2" or 3"	62-1/2" x 21-3/4"
683988	PROG50S-32P-RH67-PV	LP	50	32.0	48	80	0.65	32.4	2" or 3"	62-1/2" x 23-3/4"
PROFESSIONAL CLASSIC PLUS POWER VENT — HEAVY DUTY MODELS										
<i>Includes side water connections for space heating applications</i>										
697838	PRO+G75-76N-RH-PV	NG	75.1	75	73	110	0.59	72.8	3" or 4"	71-7/8" x 26-1/4"
697839	PRO+G75-76P-RH-PV	LP	75.1	75	73	110	0.59	72.8	3" or 4"	71-7/8" x 26-1/4"

FOR ADDITIONAL INFORMATION, VISIT THE RHEEM WEBSITE AT www.rheem.com

(†) UEF = Uniform Energy Factor

(††) Height to top of tank. Add for necessary vent clearances.

RHEEM

MANUFACTURED HOUSING ATMOSPHERIC GAS WATER HEATERS



- 0.59 - 0.60 UEF
- Certified for manufactured (HUD) and modular construction
- Guardian System & Sensor air/fuel shut-off device disables the heater in the presence of flammable vapor accumulation
- Premium-grade anode rod
- Field convertible controls and burner included for NG or LP operation
- Low NOx emissions
- Rheemglas tank lining
- Piezo ignitor—no matches required
- Enhanced flow brass drain valve
- T&P relief valve—side location
- Low lead compliant
- Two hole top for anode rod and hot water outlet
- Cold-water inlet on side



WARRANTY

- 6 year limited tank and parts, 1 year labor

ID ORDER#	MODEL#	NOM. FUEL	NOM. CAP.	NG/LP BTUH IN/HR	RATED STOR. VOL.	1ST HOUR RATING (GAL.)	UEF (†)	NG/LP RECOV 90°F RISE (GPH)	VENT SIZE	DIMENSIONS H (††) x DIA
ATMOSPHERIC MANUFACTURED HOUSING										
697236	PROG30-32N-RH63-MH	NG/LP	29	32.0/30.0	28	52	0.60	32.3/30.3	3" or 4"	59-5/8" x 16-1/2"
697880	PROG40-34N-RH62-MH	NG/LP	40	34.0/32.0	38	57	0.59	34.3/32.3	3" or 4"	61-1/2" x 18-1/2"

FOR ADDITIONAL INFORMATION, VISIT THE RHEEM WEBSITE AT www.rheem.com

(†) UEF = Uniform Energy Factor

(††) Height to top of tank. Add for necessary vent clearances.

SEPTEMBER 2024

Line #3220

RHEEM

MANUFACTURED HOUSING

DIRECT VENT GAS WATER HEATERS

400.4



- 0.57-0.59 UEF
- Certified for manufactured (HUD) and modular construction
- Premium-grade anode rod
- Field convertible controls included for NG or LP operation
- Low NOx emissions
- Piezo ignitor—no matches required
- Enhanced flow brass drain valve
- T&P relief valve—side location
- Low lead compliant
- Hot water outlet on top
- Cold-water inlet on side



WARRANTY

- 6 year limited tank and parts, 1 year labor

ID ORDER#	MODEL#	NG/LP FUEL CAP.	NOM. BTUH IN/HR	RATED STOR. VOL.	1ST HOUR RATING (GAL.)	UEF (†)	RECOV. 90°F RISE (GPH)	VENT SIZE	DIMENSIONS H (††) x DIA
DIRECT VENT MANUFACTURED HOUSING									
									* = SPECIAL ORDER ITEM
697234	PROG30-30N-RH63-MH-DV	NG/LP 30	30.0	29	46	0.57	30.3	3"	56-5/8" x 17-3/4"
697235	PROG40-30N-RH62-MH-DV	NG/LP 40	30.0	38	58	0.59	30.3	3"	57-3/8" x 19-3/4"

ACCESSORIES

187541 *	AP12017B	AIR INLET—ADJUSTABLE, 11-22"							
128904 *	AP12019B	AIR INLET—NON-ADJUSTABLE, 6"							
128900 *	AP12032B-1	ROOF JACK KIT—ADJUSTABLE, 15-32" , includes air inlet							
128901	AP12032C-1	Same as above, but 30-60"							
128902 *	AP12032D-1	Same as above, but 48-95"							
128903 *	AP12032E-1	ROOF JACK KIT—NON-ADJUSTABLE, 12" , includes air inlet							
128905	AP12021	ROOF JACK EXTENSION PIPE, 18"							

FOR ADDITIONAL INFORMATION, VISIT THE RHEEM WEBSITE AT www.rheem.com

(†) UEF = Uniform Energy Factor

(††) Height to top of tank. Add for necessary vent clearances.

RHEEM POINT-OF-USE ELECTRIC WATER HEATERS



- 2-wire, single phase electric
- Single resistored stainless steel high efficiency heating element
- Over-temperature protector
- Automatic thermostat
- Wall bracket
- T&P relief valve
- Rheemglas tank lining
- Included with 2.5 gallon model: 1/4 turn drain valve and power cord
- Included with 6, 15, and 20 gallon models: anode rod and T&P relief valve connections
- 120V AC
- Top connections on the 2.5 gallon models; side connections on all others
- Low lead compliant
- Meets or exceeds National Appliance Energy Conservation Act (NAECA) requirements
- U.L. listed and comply with Underwriter's Laboratories Specifications 174



**Professional Classic
2.5 gallon
Point-of-Use**



**Professional Classic
20 gallon
Point-of-Use**

WARRANTY

- 6 year limited tank and parts, 1 year labor

ID ORDER#	MODEL#	NOM. CAP	NPT INLET	NPT OUTLET	RELIEF VALVE CONN.	WATTS	DIMENSIONS H x DIA
PROFESSIONAL CLASSIC POINT-OF-USE ELECTRIC							* = SPECIAL ORDER ITEM
684016 *	PROE2-1-RH-POU	2.5	1/2"	1/2"	3/4"	1440	14" x 9-3/4"
684018 *	PROE6-1-RH-POU	6.0	3/4"	3/4"	3/4"	2000	15-1/4" x 15-3/4"
684015	PROE15-1-RH-POU	15.0	3/4"	3/4"	3/4"	2000	24-1/4" x 17-3/4"
684017	PROE20-1-RH-POU	19.9	3/4"	3/4"	3/4"	2000	25-1/4" x 19-3/4"

FOR ADDITIONAL INFORMATION, VISIT THE RHEEM WEBSITE AT www.rheem.com

RHEEM ELECTRIC WATER HEATERS



- 0.90 - 0.93 UEF
- Single phase electric
- HUD certified for manufactured housing and modular construction
- Resistored copper upper element and resistored Lifeguard stainless steel lower element
- System Sentinel LED diagnostic system
- Premium-grade anode rod
- Electric junction box located above heating elements
- Over-temperature protector
- Automatic thermostat
- Rheemglas tank lining
- Enhanced-flow brass drain valve
- T&P relief valve
- 240V AC
- Low lead compliant



PROE SERIES WARRANTY

- 6 year limited tank and parts (10 year limited tank warranty with ProtectionPlus), 1 year labor

PRO+E SERIES WARRANTY

- 8 year limited tank and parts (10 year limited tank warranty with ProtectionPlus), 1 year labor

ID ORDER#	MODEL#	NOM. CAP.	RATED STOR. VOL.	1ST HOUR RATING (GAL.)	RECOV. 90°F RISE (GPH)	UEF (†)	DIMENSIONS H (††) x DIA
PROFESSIONAL CLASSIC ELECTRIC MODELS — SHORT (LOWBOY)							
697884	PROE28-S2-RH95	28	25	45	21	0.92	30" x 23"
697885	PROE36-S2-RH95	36	33	46	21	0.92	31-1/2" x 24-1/4"
698838	PROE47-S2-RH95-B	47	43	54	21	0.93	32" x 26-1/4"
PROFESSIONAL CLASSIC ELECTRIC MODELS — MEDIUM							
697237	PROE40-M2-RH95	40	36	55	21	0.93	48-1/4" x 20-1/4"
773862	PRO+E50-M2-RH95	50	45	62	21	0.93	48" x 23"
PROFESSIONAL CLASSIC ELECTRIC MODELS — TALL							
697881	PROE30-T2-RH95	30	27	46	21	0.92	47-1/2" x 19-1/4"
697239	PROE50-T2-RH95	50	45	63	21	0.93	58-5/8" x 20-1/4"

FOR ADDITIONAL INFORMATION, VISIT THE RHEEM WEBSITE AT www.rheem.com

(†) UEF = Uniform Energy Factor (††) Height to top of tank. Add for necessary vent clearances.

RHEEM COMMERCIAL UNIVERSAL GAS WATER HEATERS



- Space saver design for tight retrofit applications
- 80% thermal efficiency
- Top-front-rear inlet/outlet water connections
- System Sentinel LED diagnostic system
- Stainless steel burners
- Low profile automatic flue damper
- Heavy duty vent hood
- Full-port, full-flow brass drain valve
- T&P relief valve
- Direct spark-to-pilot ignition system
- Magnesium anode rods
- Hand-hole cleanout
- Manual reset high limit
- Gas control system



NEED A NON-STOCK WATER HEATER?
We can get one shipped out of the factory in 24 hours!

NOTE:
Dielectric nipples are now field supplied. If needed, order Legend #T-575 (ID #441808).

COMMERCIAL WARRANTY

- 3 year limited tank, 3 year limited parts

ID ORDER#	MODEL#	FUEL	SIZE (GAL)	INPUT MBTU/H	FLUE SIZE	OUTPUT @ 100°F RISE (GPH)	MAXIMUM WATER DELIVERY @ 100°F RISE (in gallons incl. useable storage)			DIMENSIONS H (†) x DIA
							1 HR	2 HR	3 HR	
COMMERCIAL UNIVERSAL GAS MODELS										
86640	G76-200	NG	76	199.9	6"	194	247	441	635	68-13/16" x 26-1/4"
86642	G91-200	NG	91	199.9	6"	194	258	451	645	76-5/16" x 26-1/4"
86641 *	G76-200	LP	76	199.9	6"	194	247	441	635	68-13/16" x 26-1/4"
86643	G91-200	LP	91	199.9	6"	194	258	451	645	76-5/16" x 26-1/4"

* = SPECIAL ORDER ITEM

FOR ADDITIONAL INFORMATION, VISIT THE RHEEM WEBSITE AT www.rheem.com

(†) Height to top of tank. Add for necessary vent clearances.

RHEEM COMMERCIAL VERTICAL STORAGE TANKS

400.8



- Installed individually or manifolded
- Can provide 80% draw capability without an appreciable temperature decrease in single temperature applications
- Steel tank design with high temperature porcelain enamel
- Heavy-duty magnesium anode rods
- Rigid 2" polyurethane foam insulation
- 2" NPT circulating line connections and hot water outlet
- T&P relief valve must be ordered separately based on water heater BTU/h input
- Certified to ASME boiler and pressure vessel code standards
- Meet or exceed thermal efficiency and standby loss requirements of current ASHRAE standards



COMMERCIAL WARRANTY

- 5 year limited tank against tank leaks

ID ORDER#	MODEL#	TANK CAP.	MAX. WORKING PRESSURE (PSI)	WATER CONNECTIONS		DIMENSIONS H x DIA
				TOP OUTLET	FRONT SIDE	

VERTICAL COMMERCIAL STORAGE TANKS

122297 *	ST120	115	150	2"	2"	59-1/4" x 28-1/4"
----------	-------	-----	-----	----	----	-------------------

* = SPECIAL ORDER ITEM

FOR ADDITIONAL INFORMATION, VISIT THE RHEEM WEBSITE AT www.rheem.com

A. O. SMITH VERTEX PROLINE XE POWER VENT GAS WATER HEATERS

- 94% thermal efficiency
- Helical internal heat exchanger
- Power vent using PVC, CPVC, ABS or polypropylene pipe
- Combined vertical and horizontal runs terminating through an outside wall
- Modular blower with 120V, 60 Hz (rating 5 amps or less), 6' cord with standard 3-prong connector
- Side-mounted hot and cold recirculating taps
- Two heavy-duty anode rods
- Intelli-Vent gas control with silicon nitride hot surface ignitor (no standing pilot)
- Blue Diamond glass coating
- Green Choice gas burner
- ASME rated T&P relief valve
- 150 PSI maximum working pressure
- Meets UBC, CEC and ICC national codes; meets the thermal efficiency and standby loss requirements of the U.S. Department of Energy and ASHRAE/IES 90.1
- Listed according to ANSI Z21.10.3-CSA 4.3 standards



WARRANTY

Residential: 6 year limited tank, 6 year limited parts

Commercial: 1 year limited tank, 1 year limited parts

Note: Warranty is applicable to original owner only.

ID ORDER#	MODEL#	FUEL	NOM. CAP.	BTU IN/HR	RATED STORAGE VOL.	1ST HOUR RATING (GAL.)	UEF (†)	RECOV@ 90°F RISE (GPH)	VENT SIZE	DIMENSIONS H x DIA (††)
468280	GPHE-50 ◆	NG	50	76.0	48	124	0.88	95	2", 3" or 4"	71-1/8" x 22"

◆ available in natural gas only

This water heater is capable of venting flue gases equivalent to 25' (7.6 m) of 2" pipe, 65' (19.8 m) of 3" pipe, or 128' (39.0 m) of 4" pipe as listed in Table 1.

TABLE 1

Number of 90 Elbows	2" Maximum Pipe - ft. (m)	3" Maximum Pipe - ft. (m)	4" Maximum Pipe - ft. (m)
1	20 (6.1)	60 (18.3)	120 (36.6)
2	15 (4.6)	55 (16.8)	112 (34.1)
3	10 (3.0)	50 (15.2)	104 (31.7)
4	--	45 (13.7)	96 (29.3)
5	--	40 (12.2)	88 (26.8)
6	--	35 (10.7)	80 (24.3)

The minimum vent lengths for each of the pipe sizes is one 90° on top of the unit plus 2' (61 cm) of straight pipe and the appropriate termination.

FOR ADDITIONAL INFORMATION, VISIT THE A.O. SMITH WEBSITE AT www.hotwater.com

(†) UEF = Uniform Energy Factor

(††) Height to top of blower.

A. O. SMITH PROLINE XE POWER VENT GAS WATER HEATERS

- High efficiency, non-condensing power vent
- 3-position rotatable blower outlet
- Combined horizontal and vertical vent runs up to 180 equivalent feet with 4" diameter venting (ABS, PVC, CPVC or polypropylene)
- Built-in heat traps on water inlet and outlet
- Dynaclean diffuser dip tube
- Hot surface ignitor
- Blue Diamond glass coating
- Electronic gas control
- LED control light
- 120V, 60 Hz (rating 5 amps or less), 6' cord with standard 3-prong connector
- Enhanced-flow brass drain valve
- ASME rated T&P relief valve
- 150 PSI maximum working pressure
- Listed according to ANSI Z21.10.1-CSA 4.1 or ANSI Z21.10.3-CSA 4.3 standards



WARRANTY

Residential: 6 year limited tank, 6 year limited parts

Commercial: 1 year limited tank, 1 year limited parts

Note: Warranty is applicable to original owner only.

ID ORDER#	MODEL#	FUEL	NOM. CAP.	BTU IN/HR	RATED STORAGE VOL.	1ST HOUR RATING (GAL.)	UEF (†)	RECOV@ 90°F RISE (GPH)	VENT SIZE	DIMENSIONS H x DIA (††)
672258	GPVL-40	NG	40	40.0	38	72	0.67	45	2", 3" or 4"	59" x 22"
677261	GPVL-50	NG	50	40.0	49	79	0.72	45	2", 3" or 4"	60-1/8" x 24"
669370	GPVT-40	NG	40	50.0	38	87	0.70	56	2", 3" or 4"	68-1/2" x 20"
669395	GPVT-50	NG	50	50.0	48	97	0.72	56	2", 3" or 4"	68-1/8" x 22"
674807	GPVX-75L ◆	NG	75	76.0	72	116	0.69	80	3" or 4"	70-5/8" x 26"
672259	GPVL-40	LP	40	40.0	38	72	0.67	45	2", 3" or 4"	59" x 22"
672260	GPVL-50	LP	50	40.0	49	79	0.72	45	2", 3" or 4"	60-1/8" x 24"
674808	GPVX-75L ◆	LP	75	76.0	72	116	0.69	80	3" or 4"	70-5/8" x 26"

◆ GPVX-75L water heaters are not Energy Star qualified.

VENT LENGTH			
Model Number	Maximum Vent Length Eq. Ft.		
	2"	3"	4"
GPVL-40	50'	125'	180'
GPVL-50	50'	125'	180'
GPVT-40	50'	125'	180'
GPVT-50	50'	125'	180'
GPVX-50L	N/A	50'	125'
GPVX-75L	N/A	50'	125'

FOR ADDITIONAL INFORMATION, VISIT THE A.O. SMITH WEBSITE AT www.hotwater.com

(†) UEF = Uniform Energy Factor

(††) Height to top of blower.

A. O. SMITH PROLINE XE POWER DIRECT VENT GAS WATER HEATERS



- High efficiency, non-condensing direct vent
- Combined horizontal and vertical vent runs up to 180 equivalent feet with 4" diameter venting (PVC, CPVC, ABS or polypropylene)
- Two-pipe sealed combustion system
- Built-in heat traps on water inlet and outlet
- Dynaclean diffuser dip tube
- Hot surface ignitor
- Blue Diamond glass coating
- Electronic gas control
- LED control light
- 120V, 60 Hz (rating 5 amps or less), 6' cord with standard 3-prong connector
- Enhanced-flow brass drain valve
- ASME rated T&P relief valve
- 150 PSI maximum working pressure
- Listed according to ANSI Z21.10.3-CSA 4.3 or ANSI Z21.10.3-CSA 4.3 standards



WARRANTY

Residential: 6 year limited tank, 6 year limited parts

Commercial: 1 year limited tank, 1 year limited parts

Note: Warranty is applicable to original owner only.

ID ORDER#	MODEL#	FUEL	NOM. CAP.	BTU IN/HR	RATED STORAGE VOL.	1ST HOUR RATING (GAL.)	UEF (†)	RECOV@ 90°F RISE (GPH)	VENT SIZE	DIMENSIONS H x DIA (††)
696623	GPDL-40	NG	40	40.0	38	74	0.68	45	2", 3" or 4"	58-1/4" x 22"
696625	GPDT-50	NG	50	45.0	48	81	0.72	50	2", 3" or 4"	67-1/2" x 22"
696624	GPDL-40	LP	40	40.0	38	74	0.68	45	2", 3" or 4"	58-1/4" x 22"
696626	GPDT-50	LP	50	45.0	48	81	0.72	50	2", 3" or 4"	67-1/2" x 22"

VENT LENGTH			
Model Number	Maximum Vent Length Eq. Ft.		
	2"	3"	4"
GPDL-40	50'	125'	180'
GPDT-50	50'	125'	180'
GPDX-50L	N/A	50'	125'
GPDX-75L	N/A	50'	125'

FOR ADDITIONAL INFORMATION, VISIT THE A.O. SMITH WEBSITE AT www.hotwater.com

(†) UEF = Uniform Energy Factor (††) Height to top of blower.

A. O. SMITH PROLINE ATMOSPHERIC VENT GAS WATER HEATERS



- Intelligent control logic
- Green Choice gas burner
- Dynaclean diffuser dip tube
- Coregard anode rod
- Push-button piezo ignitor
- Heat trap nipples
- Blue Diamond glass coating
- Enhanced-flow brass drain valve
- ASME rated T&P relief valve
- 150 PSI maximum working pressure
- Meets UBC, CEC and ICC national codes; meets the thermal efficiency and standby loss requirements of the U.S. Department of Energy and ASHRAE/IES 90.1
- Listed according to ANSI Z21.10.1-CSA 4.1 standards



WARRANTY

Residential: 6 year limited tank, 6 year limited parts

Commercial: 1 year limited tank, 1 year limited parts

Note: Warranty is applicable to original owner only.

ID ORDER#	MODEL#	FUEL	NOM. CAP.	BTU IN/HR	RATED STORAGE VOL.	1ST HOUR RATING (GAL.)	UEF (†)	RECOV@ 90°F RISE (GPH)	VENT SIZE	DIMENSIONS H x DIA (††)
TALL MODELS										
* = SPECIAL ORDER ITEM										
743887	GCR-30R	NG	30	32.0	29	62	0.60	31	3" or 4"	60-1/2" x 18"
711407	GCB-40	NG	40	40.0	38	78	0.65	42	3" or 4" ♦	61-3/4" x 18"
696600	GCR-40	NG	40	40.0	38	80	0.66	42	3" or 4"	61-3/4" x 20"
734266	GCR-50	NG	50	40.0	48	84	0.62	43	3" or 4"	60-3/4" x 22"
696606	GCRT-50	NG	50	50.0	48	89	0.61	54	4"	60-3/4" x 22"
743885	GCR-30R	LP	30	29.0	29	62	0.60	31	3" or 4"	60-1/2" x 18"
696601	GCR-40	LP	40	36.0	38	80	0.66	42	3" or 4"	61-3/4" x 20"
781417	GCR-50	LP	50	37.0	48	84	0.62	43	3" or 4"	60-3/4" x 22"
696607 *	GCRT-50	LP	50	45.0	48	89	0.61	54	4"	60-3/4" x 22"
SHORT MODELS										
771858	GCRL-30R	NG	30	32.0	29	55	0.60	32	3" or 4"	50-1/4" x 20"
696602	GCRL-40	NG	40	40.0	38	67	0.59	41	3" or 4"	51-1/2" x 22"
747087	GCRL-30R	LP	30	29.0	29	55	0.60	32	3" or 4"	50-1/4" x 20"
696591	GCRL-40	LP	40	36.0	38	67	0.59	41	3" or 4"	51-1/2" x 22"

FOR ADDITIONAL INFORMATION, VISIT THE A.O. SMITH WEBSITE AT www.hotwater.com

♦ GCB-40 units include an insulation blanket. However, the diameter dimension listed above DOES NOT INCLUDE the blanket.
 (†) UEF = Uniform Energy Factor (††) Height to top of blower.

A. O. SMITH

PROLINE HIGH CAPACITY ATMOSPHERIC VENT GAS WATER HEATERS



- Fully automatic controls with safety shutoff
- Green Choice gas burner
- Dynaclean diffuser dip tube
- Coregard anode rod
- Push-button piezo ignitor
- Heat trap nipples
- Blue Diamond glass coating
- Enhanced-flow brass drain valve
- ASME rated T&P relief valve
- 150 PSI maximum working pressure
- Meets UBC, CEC and ICC national codes; meets the thermal efficiency and standby loss requirements of the U.S. Department of Energy and ASHRAE/IES 90.1
- Listed according to ANSI Z21.10.1-CSA 4.1 standards



WARRANTY

Residential: 6 year limited tank, 6 year limited parts

Commercial: 1 year limited tank, 1 year limited parts

Note: Warranty is applicable to original owner only.

ID ORDER#	MODEL#	FUEL	NOM. CAP.	BTU IN/HR	RATED STORAGE VOL.	1ST HOUR RATING (GAL.)	UEF (†)	RECOV@ 90°F RISE (GPH)	VENT SIZE	DIMENSIONS H x DIA (††)
231180	FCG-75	NG	74	75.1	71	125	0.60	81	4"	61" x 26-1/2"
231181	FCG-75	LP	74	75.1	71	125	0.60	81	4"	61" x 26-1/2"

FOR ADDITIONAL INFORMATION, VISIT THE A.O. SMITH WEBSITE AT www.hotwater.com

(†) UEF = Uniform Energy Factor

(††) Height to top of blower.

A. O. SMITH

PROLINE MASTER ATMOSPHERIC VENT GAS WATER HEATERS



- Intelligent control logic
- Green Choice gas burner
- Dynaclean diffuser dip tube
- Coregard anode rod
- Push-button piezo ignitor
- Heat trap nipples
- Blue Diamond glass coating
- Enhanced-flow brass drain valve
- ASME rated T&P relief valve
- 150 PSI maximum working pressure
- Meets UBC, CEC and HUD national codes; meets the thermal efficiency and standby loss requirements of the U.S. Department of Energy and ASHRAE/IES 90.1
- Listed according to ANSI Z21.10.1-CSA 4.1 standards



WARRANTY

Residential: 8 year limited tank, 8 year limited parts

Commercial: 1 year limited tank, 1 year limited parts

Note: Warranty is applicable to original owner only.

ID ORDER#	MODEL#	FUEL	NOM GAL CAP	BTU IN/HR	RATED STORAGE VOL.	1ST HOUR RATING (GAL.)	UEF (†)	RECOV@ 90°F RISE (GPH)	VENT SIZE	DIMENSIONS H x DIA (††)
TALL MODELS										
718454	HWR-40	NG	40	40,000	38.0	80	0.66	42	3" or 4"	61-3/4" x 20"
718455	HWG-50	NG	50	40,000	48.0	81	0.62	41	3" or 4"	60-3/4" x 21"
SHORT MODELS										
718456	HWRL-40	NG	40	40,000	38.0	67	0.59	41	3" or 4"	51-1/2" x 22"

FOR ADDITIONAL INFORMATION, VISIT THE A.O. SMITH WEBSITE AT www.hotwater.com

(†) UEF = Uniform Energy Factor

(††) Height to top of blower.

A. O. SMITH PROLINE MOBILE HOME GAS WATER HEATERS



- Standard atmospheric and direct vent models
- Direct-vent models packaged with bottom intake air vent with an optional ducted air inlet kit
- Gas control convertible for natural and propane gas
- Side-mounted 3/4" cold water inlet; top-mounted 3/4" hot water outlet
- Green Choice gas burner
- Blue Diamond glass coating
- CoreGard anode rod
- Enhanced-flow brass drain valve
- ASME rated T&P relief valve
- 150 PSI maximum working pressure
- Complies with HUD standards for manufactured housing installation
- Meets UBC, CEC and HUD national codes; meets the thermal efficiency and standby loss requirements of the U.S. Department of Energy and ASHRAE/IES 90.1
- Listed according to ANSI Z21.10.1-CSA 4.1 standards



WARRANTY

Residential: 6 year limited tank, 6 year limited parts

Commercial: 1 year limited tank, 1 year limited parts

Note: Warranty is applicable to original owner only.

ID ORDER#	MODEL#	FUEL	NOM. CAP.	NG/LP BTU IN/HR	RATED STORAGE VOL.	1ST HOUR RATING (GAL.)	UEF (†)	RECOV@ 90°F RISE (GPH)	VENT SIZE	DIMENSIONS H x DIA (††)
-----------	--------	------	-----------	-----------------	--------------------	------------------------	---------	------------------------	-----------	-------------------------

STANDARD ATMOSPHERIC VENT

* = SPECIAL ORDER ITEM

696582	FMHR-30	NG/LP	30	35.5/32.0	29	63	0.61	36	3" or 4"	61-1/2" x 18"
696583	FMHR-40	NG/LP	40	35.5/32.0	38	59	0.58	36	3" or 4"	61-3/4" x 20"

DIRECT VENT (Includes air intake—roof jack kit is required)

696584	FMDV-30	NG/LP	30	30.0/29.0	29	60	0.61	31	3"	61" x 18"
696586	FMDV-40	NG/LP	40	32.0/29.0	38	57	0.59	33	3"	61-3/4" x 20"

DIRECT VENT ACCESSORIES

643019 *	100285333	ADJUSTABLE ROOF JACK KIT, 13"-32"								
643020	100285412	Same as above, but 32"-60"								
643021 *	100285414	Same as above, but 36"-95"								
643022 *	100285331	NON-ADJUSTABLE ROOF JACK KIT, 12"								

FOR ADDITIONAL INFORMATION, VISIT THE A.O. SMITH WEBSITE AT www.hotwater.com

(†) UEF = Uniform Energy Factor

(††) Height to top of blower.

A. O. SMITH PROLINE STANDARD ELECTRIC WATER HEATERS



- Dual 4500 watt elements
- Incoloy stainless steel lower element
- Dynaclean diffuser dip tube
- Blue Diamond glass coating
- CoreGard anode rod
- Enhanced-flow brass drain valve
- ASME rated T&P relief valve
- 150 PSI maximum working pressure
- Complies with HUD standards for manufactured housing installation
- Meets UBC and ICC national codes and listed with CEC; complies with the Federal Energy Conservation Standards
- Listed according to UL 174 standards



WARRANTY

Residential: 6 year limited tank, 6 year limited parts

Commercial: 1 year limited tank, 1 year limited parts

Note: Warranty is applicable to original owner only.

ID ORDER#	MODEL#	NOM. CAP.	RATED STORAGE VOL.	1ST HOUR RATING (GAL.)	UEF (†)	RECOV@ 90°F RISE (GPH)	ELEMENT STD.	WATTAGE MIN.	240V MAX.	DIMENSIONS H x DIA (††)
TALL MODELS										
696608	ENT-30	30	27	48	0.89	21	4500	1000	6000	46-1/2" x 19"
696609	ENT-40	40	36	53	0.92	21	4500	3500	6000	61-1/4" x 18"
696610	ENT-50	50	46	62	0.93	21	4500	3000	6000	60-1/2" x 20-1/2"
SHORT MODELS										
696617	ENS-50	50	46	57	0.92	21	4500	2500	6000	49-1/4" x 23"
LOW BOY TOP CONNECT MODELS										
718506	ENL-36	36	33	51	0.92	21	4500	4500	6000	32" x 24"
757447	ENL-50	51	48	51	0.92	21	4500	4500	6000	36" x 26-1/2"

FOR ADDITIONAL INFORMATION, VISIT THE A.O. SMITH WEBSITE AT www.hotwater.com

(†) UEF = Uniform Energy Factor (††) Height to top of blower.

A. O. SMITH LIGHT-SERVICE COMMERCIAL ELECTRIC WATER HEATERS



- Dual rated
- (2) 6.1KW zinc-plated copper sheathed elements
- 277V single phase standard voltage (†)
- Blue Diamond glass coating
- Top-mounted junction box
- Adjustable thermostat with manual reset high temperature cutoff
- Heater wired for simultaneous single phase operation
- CoreGard anode rod
- Enhanced-flow brass drain valve
- ASME rated T&P relief valve
- 150 PSI maximum working pressure
- Certified to UL 1453 for commercial electric water heaters
- Meets the standby loss requirements of the U.S. Department of Energy and current edition of ASHRAE/IES 90.1



WARRANTY

Commercial: 6 year limited tank, 1 year limited parts

Note: These units can be used for both residential and commercial applications. Warranty is applicable to original owner only.

ID ORDER#	MODEL#	GAL. CAP.	WATTAGE	INPUT CONN.	OUTPUT CONN.	DIMENSIONS H x DIA (††)
761753	LTE-80D	80	6100	3/4"	3/4"	60-1/2" x 24"

ACCESSORIES (†)

762020	100293211	CONVERSION KIT , for LTE-80D, reduces voltage from 277V to 208V
762618	100293212	INSTRUCTION SHEET AND RATING PLATE OVERLAYS

FOR ADDITIONAL INFORMATION, VISIT THE A.O. SMITH WEBSITE AT www.hotwater.com

A. O. SMITH MASTER-FIT COMMERCIAL GAS WATER HEATERS



- 80% thermal efficiency
- Built-in induced draft blower
- Factory-installed draft diverter and flue damper
- The Eliminator self-cleaning system
- Front, top or rear hot and cold water connections
(The Eliminator system operates when cold water is connected through the front)
- PermaGlas Ultra Coat glass lining
- CoreGard anode rods
- Intermittent electronic ignition
- ASME rated T&P relief valve
- 160 PSI maximum working pressure
- Fully automatic control system with manual reset gas shutoff device
- Adjustable thermostat with 120°F-180°F range
- Gas pressure regulator and pilot filter
- Handhole cleanout
- Meets the thermal efficiency and standby loss requirements of the U.S. Department of Energy and ASHRAE/IES 90.1
- Listed according to ANSI Z21.10.3-CSA 4.3 standards



WARRANTY

Commercial: 3 year limited tank, 1 year limited parts

Note: Warranty is applicable to original owner only.

ID ORDER#	MODEL#	FUEL	GAL. CAP.	BTUH IN/HR	RECOV@ 40°F RISE (GPH)	RECOV@ 100°F RISE (GPH)	RECOV@ 140°F RISE (GPH)	VENT SIZE	DIMENSIONS H x DIA (†)
143828	BTR-199	NG	81	199.0	482	193	132	6"	67-1/2 x 27-3/4
143820	BTR-200	NG	100	199.0	482	193	132	6"	72" x 30-1/4"
143829 *	BTR-199	LP	81	199.0	482	193	132	6"	67-1/2 x 27-3/4
143827 *	BTR-200	LP	100	199.0	482	193	132	6"	72" x 30-1/4"

* = SPECIAL ORDER ITEM

FOR ADDITIONAL INFORMATION, VISIT THE A.O. SMITH WEBSITE AT www.hotwater.com

(†) Height to top of blower.

A. O. SMITH CYCLONE Mxi COMMERCIAL GAS WATER HEATERS



- Intelligent control system with touch screen display and iCOMM connectivity onboard with remote monitoring
- Submerged combustion chamber with helical heat exchanger coil
- Powered anodes
- PermaGlas Ultra Coat glass lining
- Versatile venting—conventional power venting or direct venting vertically or through a sidewall
- Front located exhaust and condensate connections
- Uses PVC, CPVC, polypropylene and AL29-4C stainless steel vent materials
- Direct vent intake and exhaust pipe can terminate separately outside building or through single opening using concentric vent assembly
- High efficiency modulating pre-mix powered burner
- ASME rated T&P relief valve
- 160 PSI maximum working pressure
- Handhole cleanout
- Meets the thermal efficiency and standby loss requirements of the U.S. Department of Energy and ASHRAE/IES 90.1
- Listed according to ANSI Z21.10.3-CSA 4.3 standards
- Complies with SCAQMD rule 1146.2 and other air quality management districts with similar ultra-low NOx emission



WARRANTY

Commercial: 3 year limited tank, 1 year limited parts

Note: Warranty is applicable to original owner only.

ID ORDER#	MODEL#	FUEL	GAL. CAP.	BTUH IN/HR	RECOV@ 40°F RISE (GPH)	RECOV@ 100°F RISE (GPH)	RECOV@ 140°F RISE (GPH)	VENT SIZE	DIMENSIONS H x DIA (†)
692689 *	BTH-120	NG	60	120.0	345	138	99	3"	55-1/2 x 27-3/4"
692693	BTH-199	NG	100	199.9	588	235	168	3"	76-1/2" x 27-3/4"
692688 *	BTH-120	LP	60	120.0	345	138	99	3"	55-1/2 x 27-3/4"
692692 *	BTH-199	LP	100	199.9	588	235	168	3"	76-1/2" x 27-3/4"

ACCESSORIES

208759 100112163 **CONCENTRIC VENT TERMINATION KIT**, for BTH-120 through BTH-300 heaters (old number=100111100)

* = SPECIAL ORDER ITEM

FOR ADDITIONAL INFORMATION, VISIT THE A.O. SMITH WEBSITE AT www.hotwater.com

(†) Overall height.

A. O. SMITH

TJV VERTICAL COMMERCIAL STORAGE TANKS



- For use with gas-fired copper heat exchanger equipment for storage of any potable water water at temperatures up to 180°F
- Glass-lined tank with alkaline borosilicate composition permanently fused to steel
- High density foam insulation
- Heavy gauge steel jacket with baked enamel finish
- Tank furnished with threaded openings for thermometer, relief valve, 2" recirculation lines, tankstat, and drain valve
- Storage tank meets or exceeds R12.5 minimum thermal insulation requirements of the U.S. Department of Energy and current ASHRAE/IESNA 90.1
- T&P relief valve must be ordered separately based on water heater BTU/h input
- Certified to ASME boiler and pressure vessel code standards
- Meet or exceed thermal efficiency and standby loss requirements of current ASHRAE standards



COMMERCIAL WARRANTY

- 5 year limited tank warranty (installation, labor, handling/delivery are extra)

ID ORDER#	MODEL#	NOM. CAPACITY (GAL.)	MAX. WORKING PRESSURE (PSI)	WATER CONNECTIONS TOP OUTLET	FRONT SIDE	DIMENSIONS H x DIA
--------------	--------	----------------------------	--------------------------------	---------------------------------	------------	-----------------------

VERTICAL COMMERCIAL STORAGE TANKS

170224	TJV-120M	119	160	2"	2"	62" x 29-3/8"
--------	----------	-----	-----	----	----	---------------

ACCESSORIES

721859	311-102	BRASS NIPPLE , 1" x 2", lead-free				
585494	TP3000-5C-150C	WILKINS T&P STORAGE VESSEL RELIEF VALVE , 1", 150 psi				

FOR ADDITIONAL INFORMATION, VISIT THE A.O. SMITH WEBSITE AT www.hotwater.com

STIEBEL ELTRON ELECTRIC WATER HEATERS

STIEBEL ELTRON



**SHC-6 Electric
Point-of-Use Mini
Tank Water Heater**



**PSH-20-Plus Electric
Point-of-Use Tank
Water Heater**



**Tempra-20 Plus
Whole House Electric
Tankless Water Heater**

ID ORDER#	MODEL#	NOM. WATER VOLUME (GAL.)	PHASE	VOLTAGE	WATTAGE	DIMENSIONS
--------------	--------	--------------------------------	-------	---------	---------	------------

ELECTRIC POINT-OF-USE MINI TANK WATER HEATERS

(wall-mounted, plug-in, glass-lined tank, fast recovery, brass plumbing connections, includes T&P valve, 6 year tank warranty)

762832 *	SHC-2.5 (233219)	2.65	1 phase	120V	1300W	11"W x 10-5/8"D x 18-11/16"H
762104	SHC-4 (234046)	3.96	1 phase	120V	1300W	12-5/8"W x 12-1/2"D x 19-3/4"H
767901	SHC-6 (235089)	6.0	1 phase	120V	1300W	15-1/8"W x 15"D x 20-1/2"H

ELECTRIC POINT-OF-USE TANK WATER HEATER

(wall-mounted, special porcelain enamel coating, sacrificial magnesium anode, includes T&P valve, 6 year tank warranty)

769364	PSH-20-Plus (235968)	21.0	1 phase	240/208V	3267W	20"Dia x 20-1/2"D x 36-1/4"H
--------	-------------------------	------	---------	----------	-------	------------------------------

WHOLE HOUSE ELECTRIC TANKLESS WATER HEATER

(wall-mounted, self-modulating energy technology, no venting required, advanced flow control, 7/3 year warranty)

766539	Tempra 20 Plus (239221)	20.0	1 phase	240/208V	19.2/14.4 Kw	16-5/8"W x 4-5/8"D x 14-1/2"H
757248	Tempra 24 Plus (239222)	24.0	1 phase	240/208V	24.0/18.0 Kw	16-5/8"W x 4-5/8"D x 14-1/2"H

ACCESSORIES

769413 *	328651	DRAIN PAN , for PSH-Plus
----------	--------	---------------------------------

**FOR ADDITIONAL INFORMATION, VISIT THE
STIEBEL ELTRON WEBSITE AT www.stiebel-eltron-usa.com**

WEIL-McLAIN RESIDENTIAL BOILER COMPARISON CHART



GAS BOILERS				
Model	ECO	ECO Tec	Evergreen	GV90+
Fuel	Natural/LP	Natural (LP Optional)	Natural (LP Optional)	Natural/LP
Efficiency (AFUE)	95%	95%	95%	91%
Input (MBH)	110-155 MBH Wall Mount Floor Stand Option	80-199 MBH Wall Mount Floor Stand Option	70-399 MBH Floor and Wall Mount Option	70-175 MBH
LWCO	NO	NO	NO	NO
Venting	Direct Vent	Direct Vent	Direct Vent	Direct Exhaust or Direct Vent
Water or Steam	Water	Water	Water	Water
Tankless Coil	No	No	No	No
Heat Exchanger	Stainless Steel	Stainless Steel	Stainless Steel	Cast Iron
Energy Star	YES	YES	YES	YES

GAS BOILERS						OIL BOILERS
Model	CGa (S2)	CGa (S3)	CGi (S3)	CGi (S4)	EG/PEG	WGO (R)
Fuel	Natural/LP	Natural/LP	Natural/LP	Natural/LP	Natural	Oil
Efficiency (AFUE)	83%-84%	84%	83%-85%	82%-85%	82%	86.1%-86.4%
Input (MBH)	52-245 MBH	38-233 MBH	60-167 MBH	48-222 MBH	75-250 MBH	98-357 MBH .70-2.55 GPH
LWCO	NO	YES	NO	YES	NO	NO
Venting	Chimney	Chimney	Chimney Direct Exhaust	Chimney Direct Exhaust	Chimney	Chimney
Water or Steam	Water	Water	Water	Water	Steam 196-750 sq. ft.	Water
Tankless Coil	No	No	No	No	Available non-stock	No
Heat Exchanger	Cast Iron	Cast Iron	Cast Iron	Cast Iron	Cast Iron	Cast Iron
Energy Star	NO	NO	NO	NO	NO	YES

WEIL-McLAIN

ECO WALL MOUNT GAS-FIRED BOILERS

SERIES 2



- Natural gas with LP conversion kit
- 95% AFUE efficiency
- Stainless steel fire tube heat exchanger
- 30 PSI ASME relief valve
- Drain valve
- Stainless steel burner
- Direct spark ignition
- Variable speed blower assembly
- Venturi mixing system with air silencer
- Negative pressure regulated gas valve
- 50 VA transformer
- Dual scale temperature and pressure gauge
- Outlet water temperature sensor
- Inlet water temperature sensor
- Flue gas temperature sensor
- Outdoor temperature sensor
- Low NOx SCAQMD compliant
- PVC, CPVC, PP and SS vent materials
- Control module with 3.5" LCD screen, central heat circulator control, DHW circulator control with priority, ignition control, high limit and modulating temperature control, outdoor reset, freeze protection, and circulator exercising
- Control module can be mounted on boiler or the wall (up to 2' away)
- Corrosion-resistant polypropylene condensate
- Complete jacket assembly



RESIDENTIAL WARRANTY

- 12 year limited heat exchanger, 2 year limited parts, all from date of installation

COMMERCIAL WARRANTY

- 10 year limited heat exchanger, 1 year limited parts, all from date of installation

DIMENSIONS			
MODEL	WIDTH	HEIGHT	DEPTH
ECO-110	17-3/4"	32-3/4"	18-1/2"
ECO-115	17-3/4"	32-3/4"	18-1/2"

Note: Allow for vent clearances and LCD screen.

WHILE SUPPLIES LAST

ID ORDER#	MODEL#	INPUT MBH		DOE HEATING CAPACITY	NET AHRI WATER RATINGS	DOE AFUE	VENT DIA.	TAPPING		GAS CONN SIZE	MIN. RECOMM. PIPE SIZE	VOL (GAL)
		(MAX)	(MIN)	MBH	MBH			SUPPLY	RETURN			
719354	ECO-155	155	28	143	124	95.1	3"	1-1/4"	1-1/4"	1/2"	1-1/4"	3.2

ACCESSORIES

- 721918 383-700-243 **MAINTENANCE KIT**, for ECO-110 boilers
- 692537 383-700-200 *Same as above, but ECO-155 boilers*
- 683197 383-800-101 **ECO FLOOR STAND**, low profile

FOR ADDITIONAL INFORMATION, VISIT THE WEIL-McLAIN WEBSITE AT www.weil-mclain.com

WEIL-McLAIN

ECO-TEC WALL MOUNT GAS-FIRED BOILERS

SERIES 1



- Natural gas with optional LP conversion kit
- 95% AFUE efficiency
- 10:1 turndown ratio (110-199 sizes); 8:1 turndown ratio (80 size)
- Stainless steel fire tube heat exchanger
- 30 PSI ASME relief valve
- Drain valve
- Stainless steel burner
- Direct spark ignition
- Variable speed blower assembly
- Venturi mixing system with air silencer
- Negative pressure regulated gas valve
- 50 VA transformer
- Dual scale temperature and pressure gauge
- Outlet water temperature sensor
- Inlet water temperature sensor
- Flue gas temperature sensor
- Outdoor temperature sensor
- Low NOx SCAQMD compliant
- PVC, CPVC, PP and SS vent materials
- Control module with 3.5" LCD screen, central heat circulator control, DHW circulator control with priority, ignition control, high limit and modulating temperature control, outdoor reset, freeze protection, and circulator exercising
- Fixed control module
- Corrosion-resistant polypropylene condensate
- Complete jacket assembly
- Unity 2.0 control with color touch screen
- System temperature sensor kit required for primary/secondary piping

RESIDENTIAL WARRANTY
(Transferable, non-prorated)

- 12 year primary heat exchanger, 2 year limited parts without registration, 5 year with registration, all from date of installation (registration within 90 days of installation)

COMMERCIAL WARRANTY
(Transferable, non-prorated)

- 10 year limited heat exchanger, 1 year limited parts, all from date of installation

DIMENSIONS			
MODEL	WIDTH	HEIGHT	DEPTH
ECO-TEC-80 — ECO-TEC-199	20"	33"	19-15/16"

Note: Allow for vent clearances.

DOMESTIC HOT WATER FLOW RISE Gallons Per Minute @ Temp Rise			
Model	70°F	75°F	77°F
110-C	3.0	2.9	2.8
150-C	4.1	3.9	3.8
199-C	5.4	5.0	4.9

WHILE SUPPLIES LAST

ID ORDER#	MODEL#	PART#	INPUT MBH	DOE HEATING CAP.	NET AHRI WATER RATINGS	VENT DIA.	HEATING SYSTEM TAPPING		GAS CONN SIZE	MIN. RECOMM. PIPE SIZE	VOL (GAL)
				MBH	MBH		SUPPLY	RETURN			
HEAT ONLY BOILER WITH PUMP											
746826	ECO-TEC-150	383-900-155	150	139	121	2" or 3" (PVC 3" only)	1"	1"	1/2"	1-1/2"	3.1
COMBI BOILER WITH PUMP											
746833	ECO-TEC-199	383-900-152	199	184	160	2" or 3" (PVC 3" only)	1"	1"	1/2"	1-1/2"	3.8

FOR ECO-TEC ACCESSORIES, SEE PAGE 402.4
FOR ADDITIONAL INFORMATION, VISIT THE WEIL-McLAIN WEBSITE AT www.weil-mclain.com

WEIL-McLAIN

ECO-TEC WALL MOUNT GAS-FIRED BOILERS

SERIES 2



- Natural gas with optional LP conversion kit
- Bluetooth connectivity
- 95% AFUE efficiency
- 10:1 turndown ratio (110-199 sizes); 8:1 turndown ratio (80 size)
- Stainless steel fire tube heat exchanger
- 30 PSI ASME relief valve
- Drain valve
- Stainless steel burner
- Direct spark ignition
- Variable speed blower assembly
- Venturi mixing system with air silencer
- Negative pressure regulated gas valve
- 50 VA transformer
- Dual scale temperature and pressure gauge
- Optional multi-boiler wiring kit—able to connect and operate up to 8 boilers
- Outlet water temperature sensor
- Inlet water temperature sensor
- Flue gas temperature sensor
- Outdoor temperature sensor
- Low NOx SCAQMD compliant
- PVC, CPVC, PP and SS vent materials
- Control module with 3.5" LCD screen, central heat circulator control, DHW circulator control with priority, ignition control, high limit and modulating temperature control, outdoor reset, freeze protection, and circulator exercising
- Fixed control module
- Corrosion-resistant polypropylene condensate
- Complete jacket assembly
- Unity 2.0 control with color touch screen
- System temperature sensor kit required for primary/secondary piping

RESIDENTIAL WARRANTY
(Transferable, non-prorated)

- 12 year primary heat exchanger, 2 year limited parts without registration, 5 year with registration, all from date of installation (registration within 90 days of installation)

COMMERCIAL WARRANTY
(Transferable, non-prorated)

- 10 year limited heat exchanger, 1 year limited parts, all from date of installation

DIMENSIONS			
MODEL	WIDTH	HEIGHT	DEPTH
ECO-TEC-80 — ECO-TEC-199	20"	33"	19-15/16"

Note: Allow for vent clearances.

DOMESTIC HOT WATER FLOW RISE Gallons Per Minute @ Temp Rise			
Model	70°F	75°F	77°F
110-C	3.0	2.9	2.8
150-C	4.1	3.9	3.8
199-C	5.4	5.0	4.9

ID ORDER#	MODEL#	PART#	INPUT MBH	DOE HEATING CAP. MBH	NET AHRI WATER RATINGS MBH	VENT DIA.	HEATING SYSTEM TAPPING		GAS CONN SIZE	MIN. RECOMM. PIPE SIZE	VOL (GAL)
							SUPPLY	RETURN			
HEAT ONLY BOILER BLUETOOTH WITH PUMP											
762748	ECO-TEC-80	383-900-176	80	74	64	2" or 3"	1"	1"	1/2"	1"	2.2
762752	ECO-TEC-110	383-900-177	110	100	87	2" or 3"	1"	1"	1/2"	1-1/4"	2.2
762753	ECO-TEC-150	383-900-178	150	139	121	2" or 3"	1"	1"	1/2"	1-1/2"	3.1
762754	ECO-TEC-199	383-900-179	199	184	160	2" or 3"	1"	1"	1/2"	1-1/2"	3.8
COMBI BOILER BLUETOOTH WITH PUMP											
762756	ECO-TEC-110	383-900-173	110	100	87	2" or 3"	1"	1"	1/2"	1-1/4"	2.2
762757	ECO-TEC-150	383-900-174	150	139	121	2" or 3"	1"	1"	1/2"	1-1/2"	3.1
762758	ECO-TEC-199	383-900-175	199	184	160	2" or 3"	1"	1"	1/2"	1-1/2"	3.8

FOR ECO-TEC ACCESSORIES, SEE PAGE 402.4

FOR ADDITIONAL INFORMATION, VISIT THE WEIL-McLAIN WEBSITE AT www.weil-mclain.com

WEIL-McLAIN ECO-TEC ACCESSORIES



ID ORDER#	MODEL#	DESCRIPTION
693081	383-800-102	FLOOR STAND—ADJUSTABLE , for EVG, AB Aquabalance, WM97+ and ECO-TEC boilers
746840	383-700-339	FLOOR STAND—PEDESTAL , 13", for ECO-TEC boilers
746841	383-700-265	MAINTENANCE KIT , for ECO-TEC-80/110 Series 1 & 2
746842	383-700-266	<i>Same as above</i> , but for ECO-TEC-150 Series 1 & 2
746843	383-700-267	<i>Same as above</i> , but for ECO-TEC-199 Series 1 & 2
746838	383-700-343	MANIFOLD KIT—EASY-UP , for ECO-TEC combi/heat boilers Series 1 & 2
746834	510-811-415	NG-LP CONVERSION KIT , for ECO-TEC-80/110 Series 1 & 2
746836	510-811-416	<i>Same as above</i> , but for ECO-TEC-150 Series 1 & 2
746837	510-811-417	<i>Same as above</i> , but for ECO-TEC-199 Series 1 & 2
748108	383-700-371	SYSTEM TEMPERATURE SENSOR KIT , (2) per kit, required for primary/secondary piping for Series 1 & 2
762770	383-700-272	WIRING KIT—MULTI-BOILER , for ECO-TEC Series 2 bluetooth

* = SPECIAL ORDER ITEM

FOR ADDITIONAL INFORMATION, VISIT THE WEIL-McLAIN WEBSITE AT www.weil-mclain.com

WEIL-McLAIN

EVERGREEN-PRO CONDENSING BOILERS

SERIES 1



- Natural gas with optional LP conversion kit
- 95-96.5% AFUE efficiency
- 5:1 turndown ratio (110-155);
10:1 turndown ratio (220-399)
- Stainless steel fire-tube heat exchanger
- Non-metallic heat exchanger base
- Floor standing or wall mount
- Negative regulated combustion
- Low water cut-off
- Water treatment—inhibitor and test kit
- Direct vent 100' for intake and 100' for vent
- Dual pressure zones (220-399)
- Common combustion air
- PVC, CPVC, PP and SS vent materials
- Easy installation with Setup Wizard
- Zone and/or priority based control
- 3 thermostat inputs
- Outdoor reset for each priority
- Rate adjustable per priority
- 0-10V input (modulation or setpoint)
- Four total outputs
- Modbus connectivity
- Additional heat demand contact
- Up to 8 boilers, multiple system
- Series, Parallel or SmartSequencing
- Lead boiler rotation
- 2 network priorities per boiler
- 2 local priorities per boiler
- 24 zone inputs and outputs with 8 total cascaded boilers
- Aux inputs - flow switch or end switch
- System aux outputs - system pump or damper
- Complete jacket assembly

RESIDENTIAL WARRANTY

(Transferable, non-prorated)

- 12 year primary heat exchanger, 2 year limited parts without registration, 5 year with registration, all from date of installation

COMMERCIAL WARRANTY

(Transferable, non-prorated)

- 10 year limited heat exchanger, 1 year limited parts, all from date of installation

DIMENSIONS			
MODEL	WIDTH (†)	HEIGHT (††)	DEPTH
EVG-110/155	17-5/8"	42-3/4"	18-5/8"
EVG-220/399	23"	45"	22-3/4"

(†) Includes jacket door. (††) Includes vent cover

ID ORDER#	MODEL#	INPUT MBH (MAX)	DOE HEATING CAPACITY	NET AHRI WATER RATINGS	DOE AFUE	VENT/AIR CONN. SIZE	VENT/AIR PIPE SIZE	TAPPING SUPPLY/ RETURN	MIN. GAS CONN. SIZE	RECOMM. CONN. SIZE	VOL. (GAL)
			MBH	MBH		SIZE	SIZE	SIZE	SIZE	SIZE	
726072	EVG-110	110	101	88	95.0	3"	3"	1"	1/2"	1"	2.5
726073	EVG-155	155	143	124	95.1	3"	3"	1-1/4"	1/2"	1-1/4"	3.2
699296	EVG-220	220	206	179	95.0	4"	3" or 4"	1-1/2"	3/4"	1-1/2"	4.6
699297	EVG-299	299	280	243	95.0	4"	4"	1-1/2"	3/4"	1-1/2"	7.0
699298	EVG-399	399	383	333	96.5	4"	4"	1-1/2"	3/4"	1-1/2"	6.7

ACCESSORIES

- 699299 383-900-074 **WALL MOUNT KIT**, for EVG-220, 299 and 399
- 725466 540-131-088 **NG TO LP CONVERSION KIT (LP VENTURI)**, for EVG-110
- 725467 540-202-839 *Same as above, but for EVG-155*
- 752043 540-202-849 *Same as above, but for EVG-220 (For Evergreen-Pro EVG-220 manufactured after Serial #CP7895419)*
- 733144 540-202-841 *Same as above, but for EVG-299*
- 733145 540-202-842 *Same as above, but for EVG-399*
- 721918 383-700-243 **MAINTENANCE KIT**, for EVG-110
- 692537 383-700-200 *Same as above, but for EVG-155*
- 699308 383-900-071 *Same as above, but for EVG-220*
- 699309 383-900-072 *Same as above, but for EVG-299*
- 699310 383-900-088 *Same as above, but for EVG-399*
- 693081 383-800-102 **FLOOR STAND**

FOR ADDITIONAL INFORMATION, VISIT THE WEIL-McLAIN WEBSITE AT www.weil-mclain.com

WEIL-McLAIN

AQUABALANCE GAS BOILERS

SERIES 2



- Natural gas ◆
- 95% AFUE efficiency
- 10:1 turndown ratio
- Stainless steel primary heat exchanger
- DHW flat plate heat exchanger (combi)
- Stainless steel burner
- Direct spark ignition
- 3-speed internal circulator (combi only)
- Outdoor sensor
- Honeywell control with LCD display
- 24VAC thermostat relay
- Internal condensate drain
- Relief valve
- Temperature and pressure gauge
- Low NOx rated and ASME certified
- Internal condensate trap
- 24VAC thermostat relay
- PVC, CPVC, PP and SS vent materials
- Complete jacket assembly with fully removable jacket front and sides
- Mounting bracket and hardware
- 6' plug-in 120V power cord
- 3-in-1 vent adapter

NOTE:
Add for required 124 psi T&P relief valve #TP220-5C-125C (ID # 737825).

RESIDENTIAL WARRANTY (†)

- 10 year limited heat exchanger (pro-rated for years 8-10), 2 year limited parts, all from date of installation

COMMERCIAL WARRANTY (†)

- 5 year limited heat exchanger, 1 year limited parts, all from date of installation

(†) In the "combi" model, the domestic hot water flate plate heat exchanger is covered under the parts warranty.

DIMENSIONS			
MODEL	WIDTH	HEIGHT	DEPTH
AB-80-155C	16.54"	27.56"	12.60"
AB-80-155H	16.54"	27.56"	12.60"

Note: Allow for vent clearances.

DOMESTIC HOT WATER FLOW RATE (Based on 70° temperature rise)	
AB-80C	2.0 gpm
AB-120C	3.2 gpm
AB-155C	4.0 gpm

ID ORDER#	MODEL#	INPUT MBH		DOE HEATING CAPACITY	NET AHRI WATER RATINGS	DOE AFUE	VENT DIA.	TAPPING		GAS CONN SIZE	VOL (GAL)
		(MAX)	(MIN)	MBH	MBH			SUPPLY	RETURN		

COMBINATION "COMBI" BOILERS

* = SPECIAL ORDER ITEM

735579 *	AB-80C	80	8	75	65	95.0	2" or 3"	3/4"	3/4"	1/2"	1.11
735561 *	AB-120C	120	12	112	97	95.0	2" or 3"	3/4"	3/4"	1/2"	1.31
735525 *	AB-155C	155	15.5	144	125	95.0	3"	1"	1"	3/4"	1.33

HEAT ONLY BOILERS

735526 *	AB-80H	80	8	75	65	95.0	2" or 3"	3/4"	3/4"	1/2"	1.03
735583 *	AB-120H	120	12	112	97	95.0	2" or 3"	3/4"	3/4"	1/2"	1.23
735584 *	AB-155H	155	15.5	144	125	95.0	3"	1"	1"	3/4"	1.23

ACCESSORIES

721952 *	640-000-024	NG TO LP CONVERSION KIT , for AB-80
721953 *	640-000-025	Same as above, but for AB-120
736614 *	640-000-133	Same as above, but for AB-155
693081	383-800-102	FLOOR STAND

WEIL-McLAIN

GV90+ CAST IRON GAS BOILERS

SERIES 2



- Natural gas with LP conversion kit
- 91-91.9% AFUE efficiency
- Cast iron primary heat exchanger
- Cast iron section with built-in air separator
- Stainless steel secondary heat exchanger with air separator
- Steel base
- Control module with indicator lights
- Blower assembly with observation port
- Gas/air manifold assembly
- Gas/air orifice plate for natural gas (separate plate furnished for conversion to LP)
- Stainless steel burner cone and ring assembly
- Negative regulation gas valve
- Hot surface ignition system
- Air pressure switch
- System circulator
- Built-in-bypass circulator system with sensor for temperature control
- Condensate drain trap
- Sidewall vent termination kit
- 40VA transformer
- 30 PSI ASME relief valve (boiler sections and secondary heat exchanger tested for 50 PSI working pressure)
- Water temperature limit switch
- Section block temperature limit switch
- Combination pressure-temperature gauge
- Drain valve
- PVC, CPVC, PP and SS vent materials



RESIDENTIAL WARRANTY

- 20 year limited cast iron primary heat exchanger section assembly, 5 year stainless steel secondary heat exchanger, 2 year limited parts, all from date of installation

COMMERCIAL WARRANTY

- 10 year limited cast iron primary heat exchanger, section assembly, 5 year stainless steel secondary heat exchanger, 2 year limited parts, all from date of installation

DIMENSIONS			
MODEL	WIDTH (†)	HEIGHT	DEPTH
GV90+3/+4	24-5/8"	30-3/4"	30-3/4"
GV90+5/+6	24-5/8"	30-3/4"	37-3/4"

(†) Includes heat exchanger.

ID ORDER#	MODEL#	INPUT MBH (MAX)	DOE HEATING CAPACITY	NET AHRI WATER RATINGS	DOE AFUE	VENT DIA.	TAPPING		GAS CONN SIZE	MIN. RECOMM. PIPE SIZE	VOL (GAL)
			MBH	MBH			SUPPLY	RETURN			
665401	GV90+3	70	65	56	91.9	3"	1"	1"	1/2"	1"	3.8
665402	GV90+4	105	97	84	91.2	3"	1"	1"	1/2"	1"	4.7
665403	GV90+5	140	130	113	91.4	3"	1"	1"	1/2"	1-1/4"	6.0
665406	GV90+6	175	161	140	91.0	3"	1"	1"	1/2"	1-1/4"	6.9

FOR ADDITIONAL INFORMATION, VISIT THE WEIL-McLAIN WEBSITE AT www.weil-mclain.com

WEIL-McLAIN CGa GAS BOILERS SERIES 2



- Natural gas with LP conversion kit
- 82.7-84% AFUE efficiency
- Add for low water cutoff
- Cast iron sections with built-in air separator
- Radiation plates
- Vertical draft hood
- Automatic vent damper
- Combination gas valve for 24V
- Wiring harness
- Non-linting pilot burner
- Stainless steel burners
- Electrical junction box
- Rollout thermal fuse element
- High-limit temperature control
- Spill switch
- Circulator (shipped loose; may be mounted on boiler supply or return piping)
- 30 PSI ASME relief valve (boiler sections tested for 50 PSI working pressure)
- Combination pressure-temperature gauge
- Drain valve
- Integrated boiler control module with intermittent electronic ignition system and indicator/diagnostic lights
- 40VA transformer
- Plug-in connector and wiring
- Category I appliance venting according to Part 7 venting or equipment of National Fuel Code ANSI Z223.1
- Insulated extended steel jacket with 2-piece top jacket panel



RESIDENTIAL WARRANTY

- 20 year limited heat exchanger, 2 year limited parts, all from date of installation

COMMERCIAL WARRANTY

- 10 year limited heat exchanger, 1 year limited parts, all from date of installation

DIMENSIONS			
MODEL	WIDTH (†)	HEIGHT (††)	DEPTH
CGa-25	10"	45-3/8"	23-1/4"
CGa-3	10"	52-3/8"	23-1/4"
CGa-4	13"	54-3/8"	23-1/4"
CGa-5	16"	57-7/8"	23-1/4"
CGa-6	19"	60-7/8"	23-1/4"
CGa-7	22"	62-1/8"	23-1/4"
CGa-8	25"	64-7/8"	23-1/4"

(†) Jacket width (††) Height includes vent damper

ID ORDER#	MODEL#	INPUT MBH	DOE HEATING CAPACITY MBH	NET AHRI WATER RATINGS MBH	DOE AFUE	VENT DIA.	PIPE SIZE SUPPLY	PIPE SIZE RETURN	GAS CONN SIZE	VOL. (GAL)
-----------	--------	-----------	--------------------------	----------------------------	----------	-----------	------------------	------------------	---------------	------------

LP GAS WHILE SUPPLIES LAST

667544	CGa-8-PIDL (◆)	245	204	177	82.7	7"	1-1/2"	1-1/2"	3/4"	4.4
--------	----------------	-----	-----	-----	------	----	--------	--------	------	-----

(◆) Includes damper

FOR ADDITIONAL INFORMATION, VISIT THE WEIL-McLAIN WEBSITE AT www.weil-mclain.com

WEIL-McLAIN CGa GAS BOILERS SERIES 3



- Natural gas with LP conversion kit
- 84% AFUE efficiency
- Built-in low water cutoff
- Cast iron sections with built-in air separator
- Radiation plates
- Vertical draft hood
- Automatic vent damper
- Combination gas valve for 24V
- Wiring harness
- Non-linting pilot burner
- Stainless steel burners
- Electrical junction box
- Rollout thermal fuse element
- High-limit temperature control
- Spill switch

- Circulator (shipped loose; may be mounted on boiler supply or return piping)
- 30 PSI ASME relief valve (boiler sections tested for 50 PSI working pressure)
- Combination pressure-temperature gauge
- Drain valve
- Integrated boiler control module with intermittent electronic ignition system and indicator/diagnostic lights
- 40VA transformer
- Plug-in connector and wiring
- Category I appliance venting according to Part 7 venting or equipment of National Fuel Code ANSI Z223.1
- Insulated extended steel jacket with 2-piece top jacket panel
- U.S. Department of Energy 2021 compliant



RESIDENTIAL WARRANTY
(Transferable, non-prorated)

- 20 year limited heat exchanger, 2 year limited parts, all from date of installation

COMMERCIAL WARRANTY
(Transferable, non-prorated)

- 10 year limited heat exchanger, 1 year limited parts, all from date of installation

DIMENSIONS			
MODEL	WIDTH (†)	HEIGHT (††)	DEPTH
CGa-25	10"	45-3/8"	23-1/4"
CGa-3	10"	52-3/8"	23-1/4"
CGa-4	13"	54-3/8"	23-1/4"
CGa-5	16"	57-7/8"	23-1/4"
CGa-6	19"	60-7/8"	23-1/4"
CGa-7	22"	62-1/8"	23-1/4"
CGa-8	25"	64-7/8"	23-1/4"

(†) Jacket width (††) Height includes vent damper

ID ORDER#	MODEL#	INPUT MBH	DOE HEATING CAPACITY MBH	NET AHRI WATER RATINGS MBH	DOE AFUE	VENT DIA.	PIPE SIZE SUPPLY	PIPE SIZE RETURN	GAS CONN SIZE	VOL. (GAL)
NATURAL GAS										
746706 *	CGa-25-PIDN	38	32	27	84.0	4"	3/4"	3/4"	1/2"	1.5
746707	CGa-3-PIDN	67	56	48	84.0	4"	1"	1"	1/2"	1.5
746708	CGa-4-PIDN	100	85	73	84.0	5"	1"	1"	1/2"	2.1
746710	CGa-5-PIDN	133	113	98	84.0	6"	1"	1"	1/2"	2.7
746711	CGa-6-PIDN	166	141	122	84.0	6"	1-1/4"	1-1/4"	1/2"	3.3
746712	CGa-7-PIDN	200	170	147	84.0	7"	1-1/4"	1-1/4"	3/4"	3.8
746714	CGa-8-PIDN(◆)	233	198	172	84.0	7"	1-1/2"	1-1/2"	3/4"	4.4
LP GAS										
746715 *	CGa-25-PIDN	38	32	27	84.0	4"	3/4"	3/4"	1/2"	1.5
746716	CGa-3-PIDL	67	56	48	84.0	4"	1"	1"	1/2"	1.5
746717	CGa-4-PIDL	100	85	73	84.0	5"	1"	1"	1/2"	2.1
746718	CGa-5-PIDL	133	113	98	84.0	6"	1"	1"	1/2"	2.7
746719	CGa-6-PIDL	166	141	122	84.0	6"	1-1/4"	1-1/4"	1/2"	3.3
746720	CGa-7-PIDL	200	170	147	84.0	7"	1-1/4"	1-1/4"	3/4"	3.8
746722	CGa-8-PIDL(◆)	233	198	172	84.0	7"	1-1/2"	1-1/2"	3/4"	4.4

* = SPECIAL ORDER ITEM

(◆) Includes damper

WEIL-McLAIN

CGi GOLD SERIES GAS BOILERS

SERIES 4



- Natural gas with LP conversion kit
- 84% AFUE efficiency
- Built-in low water cutoff
- Cast iron sections with built-in air separator
- Radiation plates
- Steel base
- Integrated boiler control module with intermittent electronic ignition system and indicator/diagnostic lights
- Inducer assembly (with cover—sizes 2.5-5)
- Flue gas collector/transition assembly
- Combination gas valve for 24V
- Wiring harness
- Air pressure switch
- Non-linting pilot burner
- Stainless steel burners
- 40VA transformer
- Electrical junction box
- Rollout thermal fuse element
- High-limit temperature control
- Circulator (shipped loose; may be mounted on boiler supply or return piping)
- 30 PSI ASME relief valve (boiler sections tested for 50 PSI working pressure)
- Combination pressure-temperature gauge
- Drain valve
- Category I or Category 3 appliance venting depending on application
- Insulated extended steel jacket with 2-piece top jacket panel
- U.S. Department of Energy 2021 compliant



RESIDENTIAL WARRANTY
(Transferable, non-prorated)

- 20 year limited heat exchanger, 2 year limited parts, all from date of installation

COMMERCIAL WARRANTY
(Transferable, non-prorated)

- 10 year limited heat exchanger, 1 year limited parts, all from date of installation

DIMENSIONS			
MODEL	WIDTH (†)	HEIGHT (††)	DEPTH
CGi-25	10"	45-3/8"	23-1/4"
CGi-3	10"	52-3/8"	23-1/4"
CGi-4	13"	54-3/8"	23-1/4"
CGi-5	16"	57-7/8"	23-1/4"
CGi-6	19"	60-7/8"	23-1/4"
CGi-7	22"	62-1/8"	23-1/4"
CGi-8	25"	64-7/8"	23-1/4"

(†) Jacket width (††) Height includes vent damper

ID ORDER#	MODEL#	INPUT MBH	DOE	NET AHRI	DOE AFUE	VENT DIA.	PIPE SIZE		GAS CONN SIZE	VOL. (GAL)
			HEATING CAPACITY MBH	WATER RATINGS MBH			SUPPLY	RETURN		
NATURAL GAS										
746429 *	CGi-25-PIN	48	41	35	84.0	4"	3/4"	3/4"	1/2"	1.5
746432	CGi-3-PIN	58	49	42	84.0	4"	1"	1"	1/2"	1.5
746433	CGi-4-PIN	90	77	66	84.0	5"	1"	1"	1/2"	2.1
746434	CGi-5-PIN	119	102	88	84.0	5"	1"	1"	1/2"	2.7
746435	CGi-6-PIN	158	135	117	84.0	5"	1-1/4"	1-1/4"	1/2"	3.3
746436	CGi-7-PIN	190	162	140	84.0	6"	1-1/4"	1-1/4"	3/4"	3.8
746437	CGi-8-PIN	222	189	164	84.0	6"	1-1/2"	1-1/2"	3/4"	4.4
LP GAS										
746685 *	CGi-25-PIL	48	41	35	84.0	4"	3/4"	3/4"	1/2"	1.5
746686	CGi-3-PIL	58	49	42	84.0	4"	1"	1"	1/2"	1.5
746687	CGi-4-PIL	90	77	66	84.0	5"	1"	1"	1/2"	2.1
746688	CGi-5-PIL	119	100	88	84.0	5"	1"	1"	1/2"	2.7
746689	CGi-6-PIL	158	135	117	84.0	5"	1-1/4"	1-1/4"	1/2"	3.3
746690 *	CGi-7-PIL	190	162	140	84.0	6"	1-1/4"	1-1/4"	3/4"	3.8
746691 *	CGi-8-PIL	222	189	164	84.0	6"	1-1/2"	1-1/2"	3/4"	4.4

* = SPECIAL ORDER ITEM

FOR ADDITIONAL INFORMATION, VISIT THE WEIL-McLAIN WEBSITE AT www.weil-mclain.com

WEIL-McLAIN

EG WATER GAS BOILERS

SERIES 6



- Natural gas only
- 84% AFUE efficiency
- Stocked less tankless heater only
- Less circulator
- Horizontal to vertical draft hood
- Automatic vent damper
- Combination gas valve for 24V
- Non-linting pilot burner
- Stainless steel burners
- Electrical junction box
- Spill switch
- Rollout thermal fuse element
- High-limit control
- Built-in air separator
- Plug-in connector and wiring
- 30 PSI ASME relief valve (boiler sections tested for 50 PSI working pressure)
- 40VA transformer
- Combination pressure temperature gauge
- Intermittent electronic ignition system with indicator/diagnostic lights and integrated low water cutoff with test button (without tankless coil)
- Category I appliance venting according to Part 7 venting or equipment of National Fuel Code ANSI Z223.1
- Insulated extended steel jacket

RESIDENTIAL WARRANTY
(Transferable, non-prorated)

- 20 year limited heat exchanger, 2 year limited parts, all from date of installation

COMMERCIAL WARRANTY
(Transferable, non-prorated)

- 10 year limited heat exchanger, 1 year limited parts, all from date of installation

DIMENSIONS			
MODEL	WIDTH (†)	HEIGHT (††)	DEPTH (†††)
EG-30	17"	39"	40"
EG-35	17"	39"	40"
EG-40	22"	39"	40"
EG-45	22"	39"	40"
EG-50	26"	42"	40"
EG-55	26"	42"	40"
EG-65	30"	44"	40"
EG-75	34"	44"	40"

(†) Width is less controls and sight glass

(††) Height includes vent damper

(†††) Depth includes drafthood

Note: all dimensions rounded up to the nearest inch.

ID ORDER#	WATER MODEL#	PART#	INPUT MBH	HTG NET AHRI			VENT DIA.	FORCED WATER		TAPPING SUPPLY RETURN	WATER VOL. (GAL.)	GAS CONN SIZE
				CAP MBH	RATING MBH	AFUE		SUPPLY/ RETURN	SUPPLY RETURN			
757012 *	EG-30-PIDN-W	118-301-500	75	64	56	84.0	5"	1-1/2"	(2) 3"	(2) 2-1/2"	12.3	1/2"
757013	EG-35-PIDN-W	118-351-500	100	85	74	84.0	5"	1-1/2"	(2) 3"	(2) 2-1/2"	12.3	1/2"
757014	EG-40-PIDN-W	118-401-500	125	106	92	84.0	6"	1-1/2"	(2) 3"	(2) 2-1/2"	14.8	1/2"
757015	EG-45-PIDN-W	118-451-500	150	127	110	84.0	6"	1-1/2"	(2) 3"	(2) 2-1/2"	14.8	1/2"
757016	EG-50-PIDN-W	118-501-500	175	148	129	84.0	7"	1-1/2"	(2) 3"	(2) 2-1/2"	17.3	1/2"
757017	EG-55-PIDN-W	118-551-500	200	169	147	84.0	7"	1-1/2"	(2) 3"	(2) 2-1/2"	17.3	1/2"
757018	EG-65-PIDN-W	118-651-500	238	201	175	84.0	8"	1-1/2"	(2) 3"	(2) 2-1/2"	19.8	3/4"
757019	EG-75-PIDN-W	118-751-500	282	237	206	84.0	8"	1-1/2"	(2) 3"	(2) 2-1/2"	22.3	3/4"

* = SPECIAL ORDER ITEM

FOR ADDITIONAL INFORMATION, VISIT THE WEIL-McLAIN WEBSITE AT www.weil-mclain.com

WEIL-McLAIN

EG STEAM GAS BOILERS

SERIES 6



- Natural gas only
- 82% AFUE efficiency
- Stocked less tankless coil
- Horizontal to vertical draft hood
- Automatic vent damper
- Combination gas valve for 24V
- Non-linting pilot burner
- Stainless steel burners
- Electrical junction box
- Spill switch
- Rollout thermal fuse element
- High-limit control
- 15 PSI ASME relief valve (boiler sections tested for 15 PSI working pressure)
- Low water cutoff—electrode type
- 40VA transformer
- Steam pressure gauge
- Siphon
- Gauge cocks and glass
- Intermittent electronic ignition system with Weil-McLain UCM universal ignition control module
- Category I appliance venting according to Part 7 venting or equipment of National Fuel Code ANSI Z223.1
- Insulated extended steel jacket

RESIDENTIAL WARRANTY
(Transferable, non-prorated)

- 20 year limited heat exchanger, 2 year limited parts, all from date of installation

COMMERCIAL WARRANTY
(Transferable, non-prorated)

- 10 year limited heat exchanger, 1 year limited parts, all from date of installation

DIMENSIONS			
MODEL	WIDTH (†)	HEIGHT (††)	DEPTH (†††)
EG-30	17"	39"	40"
EG-35	17"	39"	40"
EG-40	22"	39"	40"
EG-45	22"	39"	40"
EG-50	26"	42"	40"
EG-55	26"	42"	40"
EG-65	30"	44"	40"
EG-75	34"	44"	40"

(†) Width is less controls and sight glass

(††) Height includes vent damper

(†††) Depth includes drafthood

Note: all dimensions rounded up to the nearest inch.

ID ORDER#	STEAM MODEL#	PART#	NET HTG AHRI			VENT DIA.	TAPPING		WATER VOL. (GAL.)	STEAM HEADER(◆)	GAS STEAM EQUAL	CONN SIZE
			INPUT MBH	CAP MBH	RATING MBH		AFUE	SUPPLY				
756958 *	EG-30-PIDN-S	118-304-500	75	62	47	82.0	5"	(2) 3"	(2) 2-1/2"	8.4	2"	1-1/2" 1/2"
756959	EG-35-PIDN-S	118-354-500	100	82	62	82.0	5"	(2) 3"	(2) 2-1/2"	8.4	2"	1-1/2" 1/2"
756796	EG-40-PIDN-S	118-404-500	125	103	77	82.0	6"	(2) 3"	(2) 2-1/2"	9.8	2-1/2"	1-1/2" 1/2"
756960	EG-45-PIDN-S	118-454-500	150	124	93	82.0	6"	(2) 3"	(2) 2-1/2"	9.8	2-1/2"	1-1/2" 1/2"
756797	EG-50-PIDN-S	118-504-500	175	145	109	82.0	7"	(2) 3"	(2) 2-1/2"	11.2	2-1/2"	1-1/2" 1/2"
756961	EG-55-PIDN-S	118-554-500	200	166	125	82.0	7"	(2) 3"	(2) 2-1/2"	11.2	3"	1-1/2" 1/2"
756798	EG-65-PIDN-S	118-654-500	238	198	149	82.0	8"	(2) 3"	(2) 2-1/2"	12.6	3"	1-1/2" 3/4"
756799	EG-75-PIDN-S	118-754-500	282	234	176	82.0	8"	(2) 3"	(2) 2-1/2"	14.0	3"	1-1/2" 3/4"

(◆) 24" minimum from water line to boiler

* = SPECIAL ORDER ITEM

FOR ADDITIONAL INFORMATION, VISIT THE WEIL-McLAIN WEBSITE AT www.weil-mclain.com

WEIL-McLAIN

PEG STEAM GAS BOILERS

SERIES 5



- Natural gas only
- 82.8-83% AFUE efficiency
- Horizontal to vertical draft hood
- Automatic vent damper (additional for PEG-75)
- Combination gas valve for 24V
- Non-linting pilot burner
- Stainless steel burners
- Electrical junction box
- Spill switch
- Rollout thermal fuse element
- High-limit temperature control
- Stocked less tankless coil

- 15 PSI ASME relief valve (boiler sections tested for 15 PSI working pressure)
- Low water cutoff—electrode type
- 40VA transformer
- Steam pressure gauge
- Siphon
- Gauge cocks and glass
- Intermittent electronic ignition system with Weil-McLain UCM universal ignition control module
- Category I appliance venting according to Part 7 venting or equipment of National Fuel Code ANSI Z223.1
- Insulated extended steel jacket



RESIDENTIAL WARRANTY

- 10 year limited heat exchanger, 2 year limited parts, all from date of installation

COMMERCIAL WARRANTY

- 10 year limited heat exchanger, 1 year limited parts, all from date of installation

DIMENSIONS			
MODEL	WIDTH (†)	HEIGHT (††)	DEPTH (†††)
PEG-30/35	17"	39"	40"
PEG-40/45	22"	39"	40"
PEG-50/55	26"	42"	40"
PEG-65	30"	44"	40"

(†) Width is less controls and sight glass

(††) Height includes vent damper

(†††) Depth includes drafthood

Note: all dimensions rounded up to the nearest inch.

WHILE SUPPLIES LAST

ID ORDER#	MODEL#	INPUT MBH	DOE	NET	DOE AFUE	VENT DIA.	TAPPING SUPPLY	TAPPING RETURN	WATER VOLUME (GALLONS)	STEAM RISER & HEADER (◆)	STEAM EQUAL	GAS CONN SIZE
			HTG. CAP. MBH	RTGS MBH								
235529	PEG-45-PIDN	150	125	94	82.9	6"	(2) 3"	(2) 2-1/2"	9.8	2-1/2"	1-1/2"	1/2"
667638	PEG-55-PIDN	200	167	125	82.8	7"	(2) 3"	(2) 2-1/2"	11.2	3"	1-1/2"	1/2"

(◆) 24" minimum from water line to boiler

FOR ADDITIONAL INFORMATION, VISIT THE WEIL-McLAIN WEBSITE AT www.weil-mclain.com

WEIL-McLAIN

PEG STEAM GAS BOILERS

SERIES 6



- Natural gas only
- 82% AFUE efficiency
- Horizontal to vertical draft hood
- Automatic vent damper
- Combination gas valve for 24V
- Non-linting pilot burner
- Stainless steel burners
- Electrical junction box
- Spill switch
- Rollout thermal fuse element
- High-limit temperature control
- Stocked less tankless coil
- 15 PSI ASME relief valve (boiler sections tested for 15 PSI working pressure)
- Low water cutoff—electrode type
- 40VA transformer
- Steam pressure gauge
- Siphon
- Gauge cocks and glass
- Intermittent electronic ignition system with Weil-McLain UCM universal ignition control module
- Category I appliance venting according to Part 7 venting or equipment of National Fuel Code ANSI Z223.1
- Insulated extended steel jacket



RESIDENTIAL WARRANTY
(Transferable, non-prorated)

- 10 year limited heat exchanger, 2 year limited parts, all from date of installation

COMMERCIAL WARRANTY
(Transferable, non-prorated)

- 10 year limited heat exchanger, 1 year limited parts, all from date of installation

DIMENSIONS			
MODEL	WIDTH (†)	HEIGHT (††)	DEPTH (†††)
PEG-30/35	17"	39"	40"
PEG-40/45	22"	39"	40"
PEG-50/55	26"	42"	40"
PEG-65	30"	44"	40"

(†) Width is less controls and sight glass
 (††) Height includes vent damper
 (†††) Depth includes draft hood

Note: all dimensions rounded up to the nearest inch.

ID ORDER#	MODEL#	INPUT MBH	STEAM		DOE AFUE	VENT DIA.	TAPPING		WATER VOL. (GAL.)	STEAM RISER & HEADER(◆)	STEAM EQUAL	GAS CONN SIZE	
			DOE CAP. MBH	NET HTG. SQ/FT			RATING	AHRI					SUPPLY
751638 *	PEG-30-PIDN	75	62	47	196	82.0	5"	(2) 3"	(2) 2-1/2"	8.4	2"	1-1/2"	1/2"
751656 *	PEG-35-PIDN	100	82	62	258	82.0	5"	(2) 3"	(2) 2-1/2"	8.4	2"	1-1/2"	1/2"
751658	PEG-40-PIDN	125	103	77	321	82.0	6"	(2) 3"	(2) 2-1/2"	9.8	2-1/2"	1-1/2"	1/2"
751680	PEG-45-PIDN	150	124	93	388	82.0	6"	(2) 3"	(2) 2-1/2"	9.8	2-1/2"	1-1/2"	1/2"
751686	PEG-50-PIDN	175	145	109	454	82.0	7"	(2) 3"	(2) 2-1/2"	11.2	2-1/2"	1-1/2"	1/2"
751689	PEG-55-PIDN	200	166	125	521	82.0	7"	(2) 3"	(2) 2-1/2"	11.2	3"	1-1/2"	1/2"
751691 *	PEG-65-PIDN	238	198	149	621	82.0	8"	(2) 3"	(2) 2-1/2"	19.8	3"	1-1/2"	3/4"

(◆) 24" minimum from water line to boiler

* = SPECIAL ORDER ITEM

FOR ADDITIONAL INFORMATION, VISIT THE WEIL-McLAIN WEBSITE AT www.weil-mclain.com

WEIL-McLAIN

LGB WATER GAS BOILERS - SERIES 2

COMMERCIAL



- Natural gas (for info on LP boilers, contact our office)
- Cast iron sections
- Aluminized steel collector hood(s) and draft hood(s)
- 120/24V control transformer
- Factory-assembled burner and base units(s) include 1-piece aluminized steel burners, a gas manifold, aluminized steel base panels and a high-temp insulated board
- Intermittent electronic ignition systems (UCS) for LGB-4 and LGB-5 boilers
- Flame Guardian panel with flame rectification electronic control system for each base assembly for LGB-6 through LGB-17 boilers

- Wiring harness with junction box and pre-wired flexible conduit
- Combination operating and high limit temperature control
- Combination pressure temperature gauge
- 30 PSI ASME relief valve—side outlet
- Built-in air eliminator in end sections
- Category I appliance venting according to Part 7 venting or equipment of National Fuel Code ANSI Z223.1

RESIDENTIAL/COMMERCIAL WARRANTY

- 10 year limited heat exchanger, 1 year limited parts, all from date of installation



NOTE: Add for low water cutoff.

ID ORDER#	WATER MODEL#	INPUT MBH	GROSS AHRI OUTPUT MBH	NET AHRI WATER RATINGS MBH	DRAFT HOOD OUTLET(S)	BOILER HP	VOL. (GAL)
161360	LGB-4WN-5WC	400	324.0	282	(1) 10"	9.70	36.5
175430	LGB-5WN-5WC	520	421.2	366	(1) 12"	12.60	45.6
63887	LGB-6WN-7WC	650	526.5	458	(1) 12"	15.70	54.7
63888	LGB-7WN-7WC	780	631.8	549	(1) 12"	18.90	63.9
63889	LGB-8WN-7WC	910	737.1	641	(1) 14"	22.00	73.0
235320	LGB-9WN-7WC	1040	842.4	733	(1) 14"	25.20	82.1
235321	LGB-10WN-7WC	1170	947.7	824	(1) 16"	28.30	91.2
235322	LGB-11WN-7WC	1300	1053.0	915	(1) 16"	31.50	100.4
235323	LGB-12WN-7WC	1430	1158.3	1007	(1) 16"	34.60	109.5
235324	LGB-13WN-7WC	1560	1263.6	1099	(2) 12"	37.80	118.6
235325	LGB-14WN-7WC	1690	1386.9	1190	(1) 12"/(1) 14"	40.90	127.7
235326	LGB-15WN-7WC	1820	1474.2	1282	(2) 14"	44.00	136.9
778400	LGB-16WN-7WC	1950	1579.5	1373	(2) 14"	47.20	146.0
778401	LGB-17WN-7WC	2080	1684.8	1465	(2) 14"	50.13	155.1

DIMENSIONS (†)			
MODEL	WIDTH	HEIGHT	DEPTH
LGB-4	21"	50-13/16"	64-1/2"
LGB-5	26"	50-13/16"	64-1/2"
LGB-6	31"	50-13/16"	64-1/2"
LGB-7	36"	50-13/16"	64-1/2"
LGB-8	41"	50-13/16"	64-1/2"
LGB-9	46"	50-13/16"	64-1/2"
LGB-10	51"	50-13/16"	64-1/2"

DIMENSIONS (†)			
MODEL	WIDTH	HEIGHT	DEPTH
LGB-11	56"	50-13/16"	64-1/2"
LGB-12	61"	50-13/16"	64-1/2"
LGB-13	66"	50-13/16"	64-1/2"
LGB-14	71"	50-13/16"	64-1/2"
LGB-15	76"	50-13/16"	64-1/2"
LGB-16	81"	50-13/16"	64-1/2"
LGB-17	86"	50-13/16"	64-1/2"

(†) Rear flue connection adds 18" to depth and requires 9" minimum clearance.

FOR LGB WATER GAS BOILER ACCESSORIES, SEE PAGE 402.17

FOR ADDITIONAL INFORMATION, VISIT THE WEIL-McLAIN WEBSITE AT www.weil-mclain.com

WEIL-McLAIN

LGB STEAM GAS BOILERS - SERIES 2

COMMERCIAL



- Natural gas (for info on LP boilers, contact our office)
- Cast iron sections
- Aluminized steel collector hood(s) and draft hood(s)
- Factory-assembled burner and base units(s) include 1-piece aluminized steel burners, a gas manifold, aluminized steel base panels and a high-temp insulated board
- Intermittent electronic ignition systems (UCS) for LGB-4 and LGB-5 boilers
- Flame guardian panel with flame rectification electronic control system for each base assembly for LGB-6 through LGB-17 boilers
- 120/24V control transformer

- Wiring harness with junction box and pre-wired flexible conduit
- Operating pressure control
- High limit pressure control
- Compound pressure-vacuum gauge
- Gauge cocks, glass and guards
- 15 PSI ASME relief valve—side outlet
- Category I appliance venting according to Part 7 venting or equipment of National Fuel Code ANSI Z223.1

RESIDENTIAL/COMMERCIAL WARRANTY

- 10 year limited heat exchanger, 1 year limited parts, all from date of installation



NOTE: Add for low water cutoff.

ID ORDER#	MODEL#	INPUT MBH	GROSS AHRI OUTPUT MBH	NET AHRI STEAM RATINGS MBH	STEAM SQ. FEET	DRAFT HOOD OUTLET(S)	BOILER HP	BOILER WATER CONTENT STEAM TO WATERLINE	CONTENT WATER-GALLONS
586368	LGB-4SN-5WC	400	324.0	243	1013	(1) 10"	9.70	23.2	36.5
175431	LGB-5SN-5WC	520	421.2	316	1317	(1) 12"	12.60	28.9	45.6
63930	LGB-6SN-7WC	650	526.5	395	1645	(1) 12"	15.70	34.6	54.7
586356	LGB-7SN-7WC	780	631.8	474	1975	(1) 12"	18.90	40.3	63.9
586370	LGB-8SN-7WC	910	737.1	553	2305	(1) 14"	22.00	46.0	73.0
235327	LGB-9SN-7WC	1040	842.4	632	2635	(1) 14"	25.20	51.9	82.1
586372	LGB-10SN-7WC	1170	947.7	711	2965	(1) 16"	28.30	57.6	91.2
235328	LGB-11SN-7WC	1300	1053.0	790	3290	(1) 16"	31.50	63.4	100.4
586373	LGB-12SN-7WC	1430	1158.3	869	3620	(1) 16"	34.60	69.1	109.5
235330	LGB-13SN-7WC	1560	1263.6	949	3955	(2) 12"	37.80	74.9	118.6
235331	LGB-14SN-7WC	1690	1368.9	1035	4315	(1) 12"/(1) 14"	40.90	80.7	127.7
235332	LGB-15SN-7WC	1820	1474.2	1123	4679	(2) 14"	44.00	86.4	136.9
778402	LGB-16SN-7WC	1950	1579.5	1211	5046	(2) 14"	47.20	92.2	146.0
778403	LGB-17SN-7WC	2080	1684.8	1298	5408	(2) 14"	50.13	98.0	155.1

DIMENSIONS (†)			
MODEL	WIDTH	HEIGHT	DEPTH
LGB-4	21"	50-13/16"	64-1/2"
LGB-5	26"	50-13/16"	64-1/2"
LGB-6	31"	50-13/16"	64-1/2"
LGB-7	36"	50-13/16"	64-1/2"
LGB-8	41"	50-13/16"	64-1/2"
LGB-9	46"	50-13/16"	64-1/2"
LGB-10	51"	50-13/16"	64-1/2"

DIMENSIONS (†)			
MODEL	WIDTH	HEIGHT	DEPTH
LGB-11	56"	50-13/16"	64-1/2"
LGB-12	61"	50-13/16"	64-1/2"
LGB-13	66"	50-13/16"	64-1/2"
LGB-14	71"	50-13/16"	64-1/2"
LGB-15	76"	50-13/16"	64-1/2"
LGB-16	81"	50-13/16"	64-1/2"
LGB-17	86"	50-13/16"	64-1/2"

(†) Rear flue connection adds 18" to depth and requires 9" minimum clearance.

FOR LGB STEAM GAS BOILER ACCESSORIES, SEE PAGE 402.17

FOR ADDITIONAL INFORMATION, VISIT THE WEIL-McLAIN WEBSITE AT www.weil-mclain.com

WEIL-McLAIN

LGB BOILER ACCESSORIES - SERIES 2

COMMERCIAL



ID ORDER#	MODEL#	DESCRIPTION
LGB WATER BOILER ACCESSORIES		
235112	510-311-026	ADJUSTABLE LIMIT , with manual reset and 3/4" NPT well, 100-240°F (=Honeywell #L4006E1117)
587292	L4006H1004	AQUASTAT—STRAP-ON WITH MANUAL RESET (HONEYWELL)
650255	500	LOW WATER CUTOFF—MANUAL (HYDROLEVEL) , #45-500, 24V, with text button and light (=Weil-McLain #511-724-282)
235113	550	Same as above, but #45-550 and 120V (=Weil-McLain #511-724-281)
LGB STEAM BOILER ACCESSORIES		
66135	511-114-526	CONTROL—#150S-MD , with low-water cutoff and automatic reset
650255	500	LOW WATER CUTOFF—MANUAL (HYDROLEVEL) , #45-500, 24V, with text button and light (=Weil-McLain #511-724-282)
235113	550	Same as above, but 45-550 and 120V (=Weil-McLain #511-724-281)
757680	CG400-2090 (45-410-2090)	LOW WATER CUTOFF—AUTOMATIC RESET (HYDROLEVEL) , with probe, 24V, automatic reset, 15 second burner off delay, 30 second burner on delay, low water indicating light, direct boiler mounting, intermittent level test every 20 minutes for 90 seconds
64985	511-114-474	LOW WATER CUTOFF—#61 , <u>less</u> manual reset, float-type
235231	511-114-479	LOW WATER CUTOFF—#63M , <u>with</u> manual reset, float-type
198735	510-312-060	STEAM HIGH LIMIT , with manual reset (=Honeywell #L404C1147)
212349	VXT-120 (45-122)	WATER FEEDER , 120V, fully programmable delay before feed and feed settings (1-5 gallon), with digital feed counter

**FOR ADDITIONAL INFORMATION, VISIT
THE WEIL-McLAIN WEBSITE AT www.weil-mclain.com**

WEIL-McLAIN

AQUA PLUS WATER HEATERS

SERIES 2



- Indirect-fired
- 316L welded stainless steel tank
- 316L stainless steel coil over 1" in diameter
- 2" thick CFC-free foam insulation
- 150 PSI T&P relief valve included
- Digital thermostat residential/ commercial capable
- Thermostat probe

- Cold water inlet
- Hot water outlet
- Boiler water outlet
- Poly resin top and bottom caps
- 150 PSI maximum tank working pressure
- 145 PSI maximum coil working pressure
- 50°F-160°F DHW operating temperature, adjustable to 180°F
- Multi-position leveling legs
- Pewter color
- Fully passivated and welding design; no anode rod needed
- **NOTE: ADD FOR MIXING VALVE**



RESIDENTIAL WARRANTY

- 12 year limited tank assembly, 2 year limited parts, all from date of installation

COMMERCIAL WARRANTY

- 7 year limited tank assembly, 1 year limited parts, all from date of installation

ID ORDER#	MODEL#	DHW SIDE STORAGE (GAL)	BOILER SIDE STORAGE (GAL)	RECOMM. FLOW RATES (GPM)	HEAD LOSS BOILER SIDE (FT)	DHW IN/OUT NPT	BOILER WATER IN/OUT NPT	DIMENSIONS DIA. x HEIGHT	
721599 *	AQUA PLUS-35	29.7	1.7	8	1.6	3/4"	1"	21-7/8"	36-3/8"
721587	AQUA PLUS-45	39.9	1.9	8	1.6	3/4"	1"	21-7/8"	46-1/4"
721601	AQUA PLUS-55	54.1	2.2	8	1.6	3/4"	1"	21-7/8"	60"
721603 *	AQUA PLUS-85	81.6	2.7	14	5.4	1"	1"(†)	26"	59-1/2"
721605 *	AQUA PLUS-105	110.9	3.9	14	7.1	1"	1"(†)	30"	59-3/4"

(†) 1-1/4" piping required

* = SPECIAL ORDER ITEM

RATINGS (WITH 50°F DOMESTIC WATER INLET AND STATED OTHER CONDITIONS)									
		200°F Boiler Water		190°F Boiler Water			180°F Boiler Water		
Aqua Plus Model	Boiler Out MBH	115°F DHW GPH	140°F DHW GPH	Boiler Out MBH	115°F DHW GPH	140°F DHW GPH	Boiler Out MBH	115°F DHW GPH	140°F DHW GPH
35	170	337	223	170	311	202	150	284	181
45	190	363	243	170	335	222	150	307	200
55	210	443	302	190	411	278	190	378	252
85	300	551	374	250	511	343	250	470	310
105	350	715	483	350	662	442	300	608	400

FOR ADDITIONAL INFORMATION, VISIT THE WEIL-McLAIN WEBSITE AT www.weil-mclain.com

WEIL-McLAIN

WGO PACKAGED OIL BOILERS

SERIES 4



- Gold Series oil boiler
- Cast iron heat exchanger
- 86.1-86.4% AFUE efficiency
- AFG 3450 RPM Beckett burner
- Aluminized steel flue collector hood with flue cap on top outlet (convertible to rear outlet)
- Swing-away burner mounting door
- Refractory blanket and target wall in combustion area
- High limit control with circulator relay, LWCO function and integrated service switch
- 2 vent pipe brackets
- Pressure/temperature gauge
- 30 PSIG ASME relief valve (boiler sections tested for 50 PSIG working pressure)
- Drain valve
- Barometric damper
- Built-in air separator
- Category I or Type L venting
- Insulated steel jacket



RESIDENTIAL WARRANTY
(Transferable, non-prorated)

- 20 year limited heat exchanger, 2 year limited parts, all from date of installation

COMMERCIAL WARRANTY
(Transferable, non-prorated)

- 10 year limited heat exchanger, 1 year limited parts, all from date of installation

DIMENSIONS			
MODEL	WIDTH	HEIGHT	DEPTH (†)
WGO-2	20-1/4"	35-5/8"	27-3/4"
WGO-3R	20-1/4"	35-5/8"	30-7/8"
WGO-4R	20-1/4"	35-5/8"	30-7/8"
WGO-5R	20-1/4"	35-5/8"	34"
WGO-6R	20-1/4"	35-5/8"	37-1/8"

(†) Includes 14" for burner

ID ORDER#	MODEL#	BURNER INPUT		HTG. CAP. MBH	DOE AFUE	NET AHRI RTGS MBH	TAPPING		MINIMUM CHIMNEY			VOL (GAL.)
		GPH	MBH				SUPPLY(◆)	RETURN	RECT.	ROUND	HEIGHT	
751622	WGO-2	0.70	98	86	86.4	75	1-1/4"	1-1/2"	8"x8"	6"	15'	11.0
751625	WGO-3R	0.80	112	98	86.2	85	1-1/4"	1-1/2"	8"x8"	6"	15'	14.9
751628 *	WGO-4R	1.00	140	122	86.2	106	1-1/4"	1-1/2"	8"x8"	6"	15'	13.4
751630 *	WGO-5R	1.20	168	147	86.1	128	1-1/4"	1-1/2"	8"x8"	7"	15'	15.9
751632 *	WGO-6R	1.40	196	171	86.1	149	1-1/4"	1-1/2"	8"x8"	7"	15'	18.4

(◆) Circulator pump

* = SPECIAL ORDER ITEM

FOR ADDITIONAL INFORMATION, VISIT THE WEIL-McLAIN WEBSITE AT www.weil-mclain.com

WEIL-McLAIN

“TT” THERMA TRIM SERIES 2 HYDRONIC BASEBOARD



Weil-McLain “TT” **Therma Trim Baseboard** is designed for hydronic heating installations in homes and apartments. It is an attractive, clean-lined, functional baseboard that fits into any home interior, from traditional to ultramodern. Therma Trim is finished in a white baked enamel, but may be painted to match woodwork or walls.

- *Metal-to-metal expansion noise is eliminated with four full-length element glides*
- *18 gauge steel front and back panels*
- *Easy connection, galvanized steel element brackets*
- *Dampers are easy to remove for cleaning and permit room-by-room temperature control with finger touch movement*
- *Aluminum fins are stamped with a full collar, completely surrounding the 3/4” copper tube for greater output and a tighter fit*
- *No sharp corners because element fins are enclosed in full-length plastic guide rails, ensuring rigidity and straight alignment of the aluminum fins*

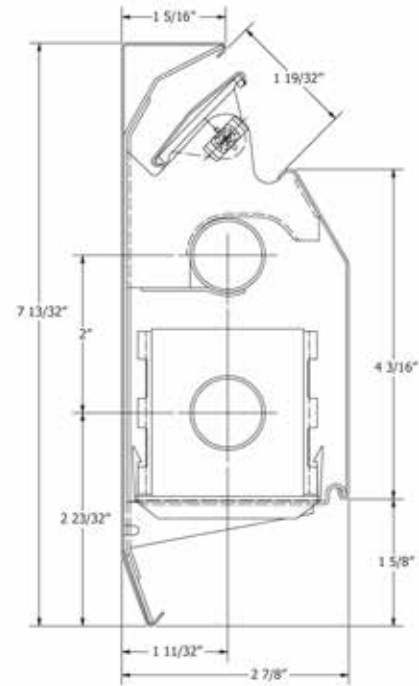

NOTE: Weil-McLain Series 2 “TT” Therma-Trim baseboard featured on this page **IS NOT COMPATIBLE** with Series 1. Although the “TT” designation remains the same, their product numbers and specifications changed as of May 2011.

Water Flow Rate		Average Water Temp (°F)											
GPM	Lbs/HR	110°	120°	130°	140°	150°	160°	170°	180°	190°	200°	210°	220°
4 (†)	2000	160	220	280	340	400	440	520	590	660	730	790	860

(†) Capacities in BTU/HR per linear foot with 65° entering air

**WHILE
SUPPLIES
LAST**

ID ORDER#	MODEL #	BTU OUT @ 180° @ 4gpm	LENGTH
SERIES 2 COMPLETE ASSEMBLY, COVER & ELEMENT (3/4”)			
638984	611-111-005	1180	2'
641653	611-111-010	1770	3'
641654	611-111-015	2360	4'
641655	611-111-020	2950	5' (††)
641658	611-111-035	4720	8' (††)
SERIES 2 COVER ONLY			
641715	611-311-090	--	5' (††)
641719	611-311-105	--	8' (††)

(††) Includes splice plate

FOR ADDITIONAL INFORMATION, VISIT THE WEIL-McLAIN WEBSITE AT www.weil-mclain.com

SEPTEMBER 2024

Line #3322

WEIL-McLAIN

“TT” THERMA TRIM SERIES 2

HYDRONIC BASEBOARD

403.21



NOTE: Weil-McLain Series 2 “TT” Therma-Trim baseboard featured on this page **IS NOT COMPATIBLE** with Series 1. Although the “TT” designation remains the same, their product numbers and specifications changed as of May 2011.

SERIES 2 ACCESSORIES

WHILE SUPPLIES LAST

ID ORDER #	MODEL #	DESCRIPTION	CTN QTY
638987	611-411-145	4" LEFT HAND END CAP , with hinge	2
638986	611-411-150	4" RIGHT HAND END CAP , with hinge	2
638988	611-411-185	2" SPLICE PLATE	1
638989	611-411-190	90° INSIDE CORNER	2
641735	611-411-195	90° OUTSIDE CORNER	6
641736	611-411-205	135° INSIDE BAY CORNER	2
641737	611-411-210	135° OUTSIDE BAY CORNER	6
641739	611-411-225	SUPPORT BRACKET WITH PIVOT	1
175863	611-410-801	FLOOR GROMMET	10
638274	592-000-002	NU-WHITE TOUCH-UP SPRAY PAINT	1

FOR ADDITIONAL INFORMATION, VISIT THE WEIL-McLAIN WEBSITE AT www.weil-mclain.com

WEIL-McLAIN

“HT” THERMA TRIM SERIES 2 HYDRONIC BASEBOARD



Weil-McLain “HT” High Trim Baseboard, designed with high output heating elements incorporated into a compact enclosure, is ideal for environments where heat loss is high or wall space is limited. The neutral colored enclosure has a baked enamel finish that resists scuffs, dents and scratches, and it can be painted or stained to match woodwork, walls or existing decor for a custom-designed appearance.

- 18 gauge steel front and back panels
- Dampers are easy to remove for cleaning and permit room-by-room temperature control with finger touch movement
- Aluminum steel element brackets feature plastic glides that snugly hold the element and eliminate expansion noises
- Element brackets have a return tube hanger built into the top arm, allowing for double tiering elements when greater output is needed (approx. 30% more)
- Corrugated aluminum fins are full collared for a permanent bond, providing maximum heating efficiency and safe, easy handling

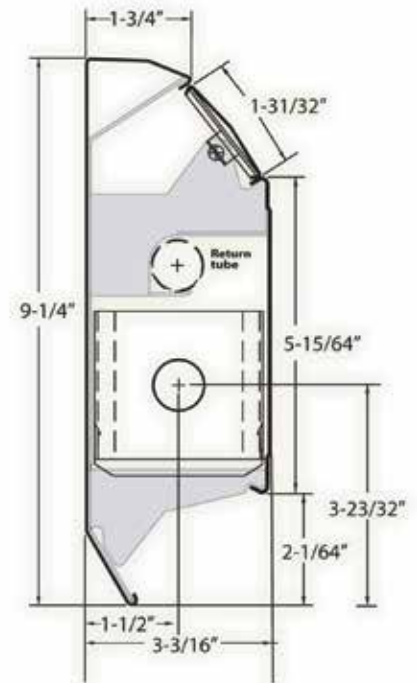

NOTE: Weil-McLain Series 2 “HT” Therma-Trim baseboard featured on this page **IS NOT COMPATIBLE** with Series 1. Although the “HT” designation remains the same, their product numbers and specifications changed as of May 2011.

Water Flow Rate		Average Water Temp (°F)													
GPM	Lbs/HR	110°	120°	130°	140°	150°	160°	170°	180°	190°	200°	---	---	---	
4 (†)	2000	210	280	350	430	510	590	680	760	850	930	1020	1060	1100	

(†) Capacities in BTU/HR per linear foot with 65° entering air

ID ORDER#	MODEL #	BTU OUT @ 180° @ 4gpm	LENGTH
COMPLETE ASSEMBLY, COVER & ELEMENT (3/4")		WHILE SUPPLIES LAST	
638263	612-111-010	2280	3'
638266	612-111-015	3040	4'
638267	612-111-020	3800	5' (††)
638269	612-111-030	5320	7' (††)
638270	612-111-035	6080	8' (††)

(††) Includes splice plate

FOR ADDITIONAL INFORMATION, VISIT THE WEIL-McLAIN WEBSITE AT www.weil-mclain.com

SEPTEMBER 2024

Line #3320

WEIL-McLAIN

“HT” THERMA TRIM SERIES 2 HYDRONIC BASEBOARD

403.23



ID ORDER#	MODEL #	LENGTH
COVER ONLY		
638313 *	612-311-080	2'
638327 *	612-311-085	3'
638286 *	612-311-090	4'
638288	612-311-095	5'
638292 *	612-311-100	6'
638293 *	612-311-105	7'
638294	612-311-110	8'

ELEMENT ONLY, 3/4"

638281 *	612-211-040	2'
638314 *	612-211-045	3'
638283 *	612-211-050	4'
638315	612-211-055	5'
638284 *	612-211-060	6'
638316 *	612-211-065	7'
638285	612-211-070	8'

SERIES 2 ACCESSORIES

ID ORDER #	MODEL #	DESCRIPTION	CTN QTY
638295	612-411-150	4" LEFT HAND END CAP , hinged	2
638299	612-411-155	4" RIGHT HAND END CAP , hinged	2
638304	612-411-170	90° INSIDE CORNER	2
638306	612-411-175	90° OUTSIDE CORNER	6
638317	612-411-185	135° INSIDE BAY CORNER	2
638318	612-411-187	135° OUTSIDE BAY CORNER	6
638305	612-411-186	2" SPLICE PLATE	24
638319 *	612-411-190	7" FILLER SLEEVE	1
638320 *	612-411-195	12" FILLER SLEEVE	1
638309	612-411-225	SUPPORT BRACKET WITH PIVOT	1
638321 *	612-411-215	PIVOT ONLY	1
175863	611-410-801	FLOOR GROMMET , per package of 10	--
638274	592-000-002	NU-WHITE TOUCH-UP SPRAY PAINT	1

* = SPECIAL ORDER ITEM

FOR ADDITIONAL INFORMATION, VISIT THE WEIL-McLAIN WEBSITE AT www.weil-mclain.com

LOCHINVAR KNIGHT FLOOR MOUNT FIRE TUBE BOILERS

- 95% AFUE efficiency
- Natural gas with optional LP conversion kit
- Modulating burner 10:1 turndown (6.7:1 turndown on KHB-055N)
- ASME stainless steel heat exchanger
- Vertical and horizontal direct vent
- Universal vent adapter
- Condensate trap
- ECM variable speed boiler circulating pump
- Direct spark ignition
- Low NOx operation
- 30 PSI ASME relief valve
- PVC, CPVC, polypropylene or SS venting up to 100'
- Built-in combustion analyzer port
- 110V convenience outlet
- Automatic reset high limit
- Adjustable high limit with manual reset
- Boiler circulating pump

- Smart System digital operating control functions and features:
 - Three boiler setpoint temperature inputs
 - Built-in sequencer with cascading redundancy for up to 8 boilers
 - Outdoor reset control with outdoor air sensor
 - Programmable system efficiency optimizers
 - Four pump control
 - Domestic hot water prioritization
 - Building management system integration
 - Graphic LCD display
 - High and low voltage terminal strips
 - Time clock
 - Data logging
 - Password security



IMPORTANT!

Please consult your local code to determine if CSD-1 controls are required.

RESIDENTIAL WARRANTY

- 15 year heat exchanger, 5 year parts

ID ORDER#	MODEL#	AFUE RATING	HEATING		CAP. MBH	NET MBH	VENT DIA.	GAS CONN.	WATER CONN.	DIMENSIONS W x D x H (†)
			INPUT MIN.	MAX.						
733075 *	KHB055N	95.0	8.3	55	51	44	2"	1/2"	1"	16" x 19" x 43-3/8"
733076	KHB085N	95.0	8.5	85	79	69	2"	1/2"	1"	16" x 19" x 43-3/8"
733077	KHB110N	95.0	11.0	110	102	89	3"	1/2"	1"	16" x 19" x 43-3/8"
733078	KHB155N	95.0	15.5	155	144	125	3"	1/2"	1"	16" x 19" x 43-3/8"
733079	KHB199N	95.0	19.9	199.9	185	161	3"	1/2"	1-1/4"	16" x 19" x 43-3/8"
733081	KHB285N	95.0	28.5	285	264	229	3"	1/2"	1-1/4"	16" x 19" x 43-3/8"

LP COVERSION KITS

706143	100268040	LP CONVERSION KIT , for KHB055N
706073	100268104	Same as above, but for KHB085N
725642	100285815	Same as above, but for KHB110N
725643	100285817	Same as above, but for KHB155N
725644	100285818	Same as above, but for KHB199N
706147	100268109	Same as above, but for KHB285N

* = SPECIAL ORDER ITEM

FOR ADDITIONAL INFORMATION, VISIT THE LOCHINVAR WEBSITE AT www.lochinvar.com

(†) Height to top of boiler. Add for necessary vent clearances.

LOCHINVAR KNIGHT WALL MOUNT FIRE TUBE BOILERS

- 94-95% AFUE efficiency
- Natural gas with optional LP conversion kit
- Modulating burner 10:1 turndown (6.7:1 turndown on WHB055N and 5:1 turndown on WHB399)
- ASME stainless steel heat exchanger
- Vertical and horizontal direct vent
- Universal vent adapter
- Condensate trap
- ECM variable speed boiler circulating pump
- Direct spark ignition
- Low NOx operation
- 30 PSI ASME relief valve
- PVC, CPVC, polypropylene or SS venting up to 100'
- Built-in combustion analyzer port
- 110V convenience outlet
- Automatic reset high limit
- Adjustable high limit with manual reset
- Boiler circulating pump

- Smart System digital operating control functions and features:
 - Three boiler setpoint temperature inputs
 - Built-in sequencer with cascading redundancy for up to 8 boilers
 - Outdoor reset control with outdoor air sensor
 - Programmable system efficiency optimizers
 - Four pump control
 - Domestic hot water prioritization
 - Building management system integration
 - Graphic LCD display
 - High and low voltage terminal strips
 - Time clock
 - Data logging
 - Password security



IMPORTANT!

Please consult your local code to determine if CSD-1 controls are required.

RESIDENTIAL WARRANTY

- 15 year heat exchanger, 5 year parts

ID ORDER#	MODEL#	AFUE RATING	INPUT MIN.	HEATING			VENT DIA.	GAS CONN.	WATER CONN.	DIMENSIONS W x D x H (ft)
				MBH MAX.	CAP. MBH	NET MBH				
732934	WHB055N	95.0	8.3	55	51	44	2"	1/2"	1"	18-3/4" x 16" x 40"
732935	WHB085N	95.0	8.5	85	79	69	2"	1/2"	1"	18-3/4" x 16" x 39-3/4"
732936	WHB110N	95.0	11.0	110	102	89	3"	1/2"	1"	18-3/4" x 19" x 41-1/4"
732937	WHB155N	95.0	15.5	155	144	125	3"	1/2"	1"	18-3/4" x 19-1/8" x 41-1/4"
733071 *	WHB199N	95.0	19.9	199.9	185 (††)	161	3"	1/2"	1-1/4"	18-3/4" x 19-1/8" x 41-3/4"
733080 *	WHB285N	95.0	28.5	285	264	229	3"	1/2"	1-1/4"	18-3/4" x 21-1/8" x 41-1/4"
733072 *	WHB399N	94.0	80.0	399	377	328	4"	3/4"	1-1/2"	25-1/4" x 21-7/8" x 43-1/4"

(††) Gross output MBH

LP CONVERSION KITS

706143	100268040	LP CONVERSION KIT , for WHB055N
706073	100268104	Same as above, but for WHB085N
725642	100285815	Same as above, but for WHB110N
725643	100285817	Same as above, but for WHB155N
725644	100285818	Same as above, but for WHB199N
706147	100268109	Same as above, but for WHB285N

* = SPECIAL ORDER ITEM

FOR ADDITIONAL INFORMATION, VISIT THE LOCHINVAR WEBSITE AT www.lochinvar.com

(ft) Height to top of vent connection outlet.

LOCHINVAR

NOBLE COMBI FLOOR MOUNT FIRE TUBE BOILERS

- 95% AFUE efficiency
- Modulating burner 10:1 turndown
- ASME stainless steel heat exchanger
- Vertical and horizontal direct vent
- Condensate trap
- Direct spark ignition
- Low NOx operation
- 50 PSI working pressure
- PVC, CPVC, polypropylene or SS venting up to 100'
- Automatic reset high limit
- Adjustable high limit with manual reset
- Boiler circulating pump
- Wall-mount bracket

- Smart System digital operating control functions and features:
 - Three boiler setpoint temperature inputs
 - Built-in cascading sequencer for up to 8 boilers
 - Outdoor reset control with outdoor air sensor
 - Programmable system efficiency optimizers
 - Two pump control
 - LCD display with words not codes
 - High voltage junction box
 - Low voltage terminal strip
 - Time clock for data logging
 - Password security



RESIDENTIAL WARRANTY

- 10 year heat exchanger, 5 year parts

IMPORTANT!

Please consult your local code to determine if CSD-1 controls are required.

ID ORDER#	MODEL#	AFUE RATING	INPUT MIN.	MBH MAX.	HEATING			GAS CONN.	WATER CONN.	DIMENSIONS W x D x H (†)
					CAP. MBH	NET MBH	VENT DIA.			
721236	NKC110N	95.0	11.0	110	102	89	3"	1/2"	1"	17-1/4" x 18" x 32-1/2"
721237	NKC150N	95.0	15.0	150	139	121	3"	1/2"	1"	18-3/4" x 18" x 32-1/2"
721238	NCK199N	95.0	19.9	199.9	185	161	3"	1/2"	1"	18-3/4" x 18" x 32-1/2"

DHW DELIVERY	
Model	GPM*
NKC110N	2.6
NKC150N	3.6
NKC199N	4.8

*77°F temperature rise

**FOR LP CONVERSION KITS, PLEASE CONTACT YOUR SALESPERSON OR OUR OFFICE
FOR ADDITIONAL INFORMATION, VISIT THE LOCHINVAR WEBSITE AT www.lochinvar.com**

(†) Height to top of boiler. Add for necessary vent clearances.

LOCHINVAR

SOLUTION TWO-STAGE COPPER TUBE BOILERS

- 84% AFUE efficiency
- ASME copper finned tube heat exchanger
- Gasketless heat exchanger design
- Built-in performance loop
- Vertical water connections
- 24V control system
- Self-diagnostic ignition control
- Terminal strip
- Intermittent electronic ignition
- Two-stage solid state temperature control
- Outdoor reset with outdoor sensor
- Domestic hot water prioritization
- Two-stage gas valve with built-in manual shut-off
- 160 PSI working pressure
- ASME pressure relief valve
- Pump relay
- Automatic reset high limit
- Temperature and pressure gauge
- Automatic vent damper
- Built-in draft diverter
- Stainless steel burners
- Loch-heat ceramic tile combustion chamber
- CSA design certified for installation on combustible floors
- CSA design certified for alcove installation



IMPORTANT!
Please consult your local code to determine if CSD-1 controls are required.

RESIDENTIAL WARRANTY

- 20 year heat exchanger, 2 year parts

ID ORDER#	MODEL#	AFUE RATING	INPUT MBH	OUTPUT		NET AHRI MBH	VENT DIA.	GAS CONN.	WATER CONN.	DIMENSIONS W x D x H (†)
				HIGH FIRE	LOW FIRE					
NATURAL GAS BOILERS (less circulating pump)										
568875 *	CBN045	84.0	45	36.9	18.45	32	4"	1/2"	1-1/2"	11-1/2" x 21-1/2" x 29-1/2"
568756	CBN075	84.0	75	61.5	30.75	54	5"	1/2"	1-1/2"	15-1/2" x 21-1/2" x 29-1/2"
568759	CBN090	84.0	90	73.8	36.90	65	5"	1/2"	1-1/2"	15-1/2" x 21-1/2" x 29-1/2"
568760	CBN135	84.0	135	110.7	55.35	97	6"	1/2"	1-1/2"	19-1/2" x 21-1/2" x 29-1/2"
568761 *	CBN180	84.0	180	147.6	73.80	130	7"	3/4"	1-1/2"	23-1/2" x 21-1/2" x 29-1/2"
568879 *	CBN215	84.0	215	176.3	88.15	155	7"	3/4"	1-1/2"	26-1/2" x 21-1/2" x 29-1/2"
568881 *	CBN260	84.0	260	213.2	106.60	188	8"	3/4"	1-1/2"	29-1/2" x 21-1/2" x 29-1/2"
LP GAS (less circulating pump)										
568877 *	CBL045	84.0	45	36.9	18.45	32	4"	1/2"	1-1/2"	11-1/2" x 21-1/2" x 29-1/2"
568762	CBL075	84.0	75	61.5	30.75	54	5"	1/2"	1-1/2"	15-1/2" x 21-1/2" x 29-1/2"
568763	CBN090	84.0	90	73.8	36.90	65	5"	1/2"	1-1/2"	15-1/2" x 21-1/2" x 29-1/2"
568764	CBL135	84.0	135	110.7	55.35	97	6"	1/2"	1-1/2"	19-1/2" x 21-1/2" x 29-1/2"
568778 *	CBL180	84.0	180	147.6	73.80	130	7"	3/4"	1-1/2"	23-1/2" x 21-1/2" x 29-1/2"
568880 *	CBL215	84.0	215	176.3	88.15	155	7"	3/4"	1-1/2"	26-1/2" x 21-1/2" x 29-1/2"
568882 *	CBL260	84.0	260	213.2	106.60	188	8"	3/4"	1-1/2"	29-1/2" x 21-1/2" x 29-1/2"

ACCESSORIES

- 568768 1001157733 **PVC BLOWER VENT KIT**, for CB Series 45 and 75 boilers
- 568769 * 100157734 **CPVC BLOWER VENT KIT**, for CB Series 90 and 135

* = SPECIAL ORDER ITEM

FOR ADDITIONAL INFORMATION, VISIT THE LOCHINVAR WEBSITE AT www.lochinvar.com

(†) Height to top of boiler. Add for necessary vent clearances.

LOCHINVAR

FTX (FTXL) FIRE TUBE COMMERCIAL BOILERS



- 97-98% thermal efficiency
- Modulating burner 10:1 turndown on FTX400N, 500N and 10000N boilers; 7:1 turndown on FTX 600N, 725N 850N
- ASME stainless steel fire-tube heat exchanger
- Vertical and horizontal direct vent
- Direct spark ignition
- Low NOx operation
- Sealed combustion
- Low gas pressure operation
- 160 PSI working pressure
- 50 PSI relief valve
- Built-in combustion analyzer port
- Category IV direct vent up to 100'
- PVC, CPVC, polypropylene or SS venting
- Adjustable high limit with manual reset
- Automatic reset high limit
- Manual reset low water cutoff
- Flue temperature sensor
- Low air pressure switch
- Temperature and pressure gauge
- Condensate trap

- Smart System digital operating control functions and features:
 - Loch-N-Link USB thumb drive port for easy programming
 - Built-in sequencer with cascading redundancy for multiple boilers
 - 3 reset temperature inputs with independent outdoor reset curves for each
 - Four pump control
 - Building management system integration
 - Programmable system efficiency optimizers
 - High and low voltage terminal strips
 - Time clock
 - Data logging
 - Password security



IMPORTANT!
Please consult your local code to determine if CSD-1 controls are required.

NOTE
Call our office to discuss installation instructions for primary/secondary piping.

COMMERCIAL WARRANTY

- 10 year heat exchanger, 1 year parts

ID ORDER#	MODEL#	THERM. EFF.	INPUT MBH MIN.	MAX.	OUTPUT MBH	NET AHRI RATING MBH	HEX VOL (GAL.)	VENT DIA.	GAS CONN.	WATER CONN.	DIMENSIONS W x D (†) x H (†)
693699	FTX400N	98.0	40.0	399.9	392	341	13	4"	1"	2"	26-1/4" x 22-1/2" x 53-1/2"
693697	FTX500N-M13	97.7	50.0	500.0	489	425	12	4"	1"	2"	26-1/4" x 22-1/2" x 53-1/2"
693694 *	FTX600N-M13	97.5	85.0	600.0	585	509	12	4"	1"	2"	26-1/4" x 22-1/2" x 53-1/2"
693524 *	FTX725N-M13	97.2	103.5	725.0	705	613	17	6"	1"	2-1/2"	26-1/4" x 22-1/2" x 53-1/2"
693094	FTX850N-M13	97.0	121.5	850.0	825	717	16	6"	1"	2-1/2"	26-1/4" x 22-1/2" x 53-1/2"
764390 *	FTX1000N-M13	98.3	99.9	999.0	982	854	19	6"	1-1/4"	2-1/2"	26-1/4" x 26-1/4" x 61-1/4"

* = SPECIAL ORDER ITEM

CALL OUR OFFICE FOR AVAILABLE FACTORY OPTIONS AND ACCESSORIES
FOR ADDITIONAL INFORMATION, VISIT THE LOCHINVAR WEBSITE AT www.lochinvar.com

(†) Height to top of boiler. Add for necessary vent clearances.

LOCHINVAR

FTX (FTXL) PRODUCT SUMMARY



	FTX400	FTX500	FTX600	FTX725	FTX850	FTX1000
WATER						
Gallon Capacity	13	12	12	17	16	19
Heating Surface (Sq. Ft.)	55.31	73.02	73.02	84.60	99.88	119.47
Water Connections	2"	2"	2"	2.5"	2.5"	2.5"
Drain	1"	1"	1"	1"	1"	1"
20 °F ΔT Water Flow (GPM)	39	49	59	71	83	98
Head Loss (Ft. of Hd.)	3.5	4.8	4.4	4.9	5.7	4.5
Max. Working Pressure (PSI)	160	160	160	160	160	160
# of Relief Valves	1	1	1	1	1	1
Relief Valve Size	3/4"	3/4"	3/4"	3/4"	3/4"	3/4"
Relief Valve Rating (MBH)	697	697	697	1,352	1,352	1,352
Relief Valve Pressure Rating (PSI)	50	50	50	50	50	50
GAS						
BTU/HR Input	399,999	500,000	600,000	725,000	850,000	999,000
BTU/HR Output (High Fire)	392,000	489,000	585,000	705,000	824,500	982,000
BTU/HR Output (Low Fire)	39,100	48,900	83,571	100,714	117,857	98,200
Inlet Connection	1"	1"	1"	1"	1"	1-1/4"
Max. Inlet Pressure, Nat. (w.c.)	14"	14"	14"	14"	14"	14"
Min. Inlet Pressure, Nat. (w.c.)	4"	5"	4"	4"	4"	4"
Max. Inlet Pressure, LP (w.c.)	14"	14"	14"	14"	14"	14"
Min. Inlet Pressure, LP (w.c.)	8"	8"	8"	8"	8"	8"
ELECTRICAL *						
Voltage/Heater (VAC)	120	120	120	120	120	120
Voltage/Control (VAC)	24	24	24	24	24	24
AMP Draw	<12	<12	<12	<12	<12	<12
# of Electrical Connections	1	1	1	1	1	1
DIMENSIONS						
Height	53-1/2"	53-1/2"	53-1/2"	53-1/2"	53-1/2"	61-1/4"
Width	26-1/4"	26-1/4"	26-1/4"	26-1/4"	26-1/4"	26-1/4"
Depth	22-1/4"	22-1/4"	22-1/4"	22-1/4"	22-1/4"	26-1/4"
SERVICE CLEARANCES (Recom.)						
Front	30"	30"	30"	30"	30"	30"
Back	24"	24"	24"	24"	24"	24"
Right Side	0"	0"	0"	0"	0"	0"
Left Side	0"	0"	0"	0"	0"	0"
Top	24"	24"	24"	24"	24"	24"
DIRECT VENTING						
Vent Size	4"	4"	4"	6"	6"	6"
Air Inlet Size	4"	4"	4"	4"	4"	6"
Vent Category	IV	IV	IV	IV	IV	IV
Vent Material	PVC/CPVC/ PP/AL29-4C	PVC/CPVC/ PP/AL29-4C	PVC/CPVC/ PP/AL29-4C	PVC/CPVC/ PP/AL29-4C	PVC/CPVC/ PP/AL29-4C	PVC/CPVC/ PP/AL29-4C

LOCHINVAR

SQUIRE INDIRECT WATER HEATERS

- 100% stainless steel construction
- 316L passivated stainless steel tank
- 316L high capacity stainless steel coil
- Fully-welded construction
- Solar indirect with SDT dual coil
- Solar indirect with SET electric back-up
- Factory-supplied tank sensor
- ASME T&P relief valve
- High density CFC/HCFC free polyurethane foam
- 1" boiler supply and return connections
- 1" domestic water connections (30, 40, 50)
- 1-1/2" domestic water connections (65, 80, 119)
- Impact and rust resistant polypropylene jacket
- Built in the USA



RESIDENTIAL WARRANTY

- Limited lifetime heat exchanger, 5 year parts

COMMERCIAL WARRANTY

- 5 year heat exchanger, 1 year parts

ID ORDER#	MODEL#	CAPACITY (GAL.)	CONT. DELIVERY (GPH) (†)	1ST HOUR DELIVERY (GAL.) (†)	MINIMUM COIL LOAD (BTU/HR) (†)	DIMENSIONS DIA. x H
601880	SIT030	27	160	184	99,000	20" x 39-1/2"
632972	SIT040	40	181	208	115,000	20" x 55-1/2"
632973	SIT050	52	210	255	133,000	24" x 48"
632971 *	SIT065	67	263	328	154,000	24" x 60"
585787	SIT080	82	266	340	160,000	24" x 69-1/2"
601883 *	SIT119	113	308	418	199,999	28" x 68-1/4"

(†) Values are based on a 14.0 GPM flow rate.

* = SPECIAL ORDER ITEM

PRESSURE DROP VALUES												
MODEL	WATER INLET (NPT)	WATER OUTLET (NPT)	COIL CONN. (NPT)	COIL LENGTH (FT.)	SQ. FT. SURFACE AREA	PRESSURE DROP (FT/HD)						
						5 GPM	8 GPM	12 GPM	16 GPM	20 GPM	25 GPM	30 GPM
SIT030	1"	1"	1"	24.0	8.0	.64	1.46	2.98	4.93	7.28	10.76	14.80
SIT040	1"	1"	1"	30.8	10.0	.74	1.69	3.44	5.68	8.40	12.41	17.08
SIT050	1"	1"	1"	36.5	12.0	.87	1.99	4.05	6.70	9.89	14.62	20.11
SIT065	1-1/2"	1-1/2"	1"	41.5	13.5	.94	2.14	4.35	7.20	10.64	15.72	21.63
SIT080	1-1/2"	1-1/2"	1"	41.5	13.5	.94	2.14	4.35	7.20	10.64	15.72	21.63
SIT119	1-1/2"	1-1/2"	1"	67.3	22.0	1.38	3.15	6.41	10.6	15.66	23.14	31.84

FOR ADDITIONAL INFORMATION, VISIT THE LOCHINVAR WEBSITE AT www.lochinvar.com

LOCHINVAR HYDRONIC BUFFER TANKS

- Glass-lined stainless steel tank
- High density foam insulation
- Textured, impact-resistant polymer jacket
- Drain valve
- Air vent connection
- Bulbwell

RESIDENTIAL WARRANTY

- RBT: 3 year tank, 1 year parts
- SBT: 5 year tank, 1 year parts



ID ORDER#	MODEL#	CAPACITY (GAL.)	SUPPLY CONNECTION	RETURN CONNECTION	DIMENSIONS DIA. x H
RBT HYDRONIC BUFFER TANKS					
700420	RBT030	30	2"	2"	20-1/2" x 34-1/2"
700499 *	RBT050	50	2"	2"	20-1/2" x 53-7/8"
700500 *	RBT080	80	2-1/2"	2-1/2"	24" x 58-3/8"
700501 *	RBT119	119	2-1/2"	2-1/2"	29-1/2" x 61-5/8"
SBT HYDRONIC BUFFER TANKS					
637439	SBT030	30	1-1/2"	1-1/2"	20" x 39-1/2"
637437 *	SBT050	50	1-1/2"	1-1/2"	24" x 47"
649312 *	SBT080	80	2"	2"	24" x 69-1/2"
658677 *	SBT119	119	2"	2"	28" x 68-1/4"

* = SPECIAL ORDER ITEM

FOR ADDITIONAL INFORMATION, VISIT THE LOCHINVAR WEBSITE AT www.lochinvar.com

RINNAI

NON-CONDENSING TANKLESS INDOOR WATER HEATERS



- Temperature controlled, continuous flow
- 0.4 GPM minimum activation rate
- Direct electronic ignition
- Direct vent, sealed combustion exhaust system (†)
- Natural gas or propane models available (††)
- Integrated condensate collector
- Circ-Logic recirculation program cycles external pump
- AC 120V, 60 Hz appliance; DC 12V remote control
- 3/4" NPT gas supply, water inlets and water outlets
- Integrated controller (#MC-91-2US)
- Includes isolation valve kit
- Certified for installation in manufactured (mobile) homes



RL75i

IMPORTANT

Some Michigan jurisdictions may require a T&P valve. Check with your local inspector before installation.

We strongly recommend that you check with your local inspector before installing a tankless heater to ensure the unit will be compliant with all applicable codes. See note above regarding T&P valve.

REGISTERED RESIDENTIAL WARRANTY

- 15 year heat exchanger
- 5 year parts
- 5 year labor (◆)

REGISTERED COMMERCIAL WARRANTY

- 6 year heat exchanger
- 5 year parts
- 2 year labor (◆)

(◆) If product is not registered within 30 days of installation, labor coverage is 1 year for residential applications and 1 year for commercial applications.

ID ORDER#	MODEL#	FUEL	MBTUH INPUT MIN-MAX	DIMENSIONS W x D x H (†††)	CAPACITY @ 70°F rise	ENERGY FACTOR
642607	RL75iN	NG	10.3-180	14" x 23" x 9"	4.3	0.82
642608	RL75iP	LP	10.3-180	14" x 23" x 9"	4.3	0.82
642609 *	RL94iN	NG	10.3-199	14" x 23" x 9"	4.7	0.82
642610 *	RL94iP	LP	10.3-199	14" x 23" x 9"	4.7	0.82

* = SPECIAL ORDER ITEM

FOR ADDITIONAL INFORMATION, VISIT THE RINNAI WEBSITE AT www.rinnai.us

(†): Add for necessary vent clearances.

(††): Units are not field convertible. Contact your R. A. Townsend Co. sales representative for information on factory conversions.

(†††): Dimensions are rounded off to the nearest inch.

NON-CONDENSING TANKLESS
INDOOR WATER HEATERS SPECIFICATIONS



SPECIFICATIONS

		RL75i	RL94i
Min. gas consumption (BTU/H)		10,300	
Max. gas consumption (BTU/H)		180,000	199,000
Hot water capacity (Min. - Max.)*		0.26 - 7.5 GPM (1.0 - 28.5 L/min)	0.26 - 9.8 GPM (1.0 - 37.0 L/min)
Temperature setting (no controller)		120°F or 140°F	
Max. temperature setting (residential) (†)		Selectable at 120°F or at 140°F	
Max. temperature setting (MCC-91 controller)		160°F	185°F
Min. temperature setting		98°F	
Energy factor		0.82	
Noise level		49 db (excluding start up or shutdown)	
Electrical data	Normal	76 W	97 W
	Standby	2 W	
	Anti-frost protection	120 W	
	Maximum current	Without recirculation pump: 4 AMPS With recirculation pump: 8 AMPS (exact value depends on the pump)	
	Fuse	10 AMPS	
By-pass control		Fixed	Electronic
Gas supply pressure	Natural gas	4.0 - 10.5 inch W.C.	
	Propane	8.0 - 13.5 inch W.C.	
Type of appliances		Direct vent, tankless, temperature controlled continuous flow gas hot water sys.	
Connections		Gas supply: 3/4" MNPT; cold water inlet: 3/4" MNPT; hot water outlet: 3/4" MNPT	
Ignition system		Direct electronic ignition	
Electric connections		Appliance: AC 120V, 60 Hz; temperature controller: DC 12V (digital)	
Water temperature control		Simulated feed forward and feedback	
Min. water supply pressure		20 PSI (recomm. 30-80 PSI for max. performance)	
Max. water supply pressure		150 PSI	
Temperature control cable		Non-polarized two core cable (min. 22 AWG)	
Energy Star qualified		Yes	
Certified for installation in manufactured homes		Yes	

(†) Temperatures above 140°F require MCC-91-2W commercial controller

* Minimum flow may vary slightly depending on the temperature setting and the inlet water temperature. Minimum activation flow is 0.4 GPM (1.5 L/min).

The maximum inlet gas pressure must not exceed the value specified by the manufacturer. The minimum value listed is for the purpose of input adjustment.

NON-CONDENSING TANKLESS INDOOR WATER HEATERS SPECIFICATIONS



WATER FLOW CURVE

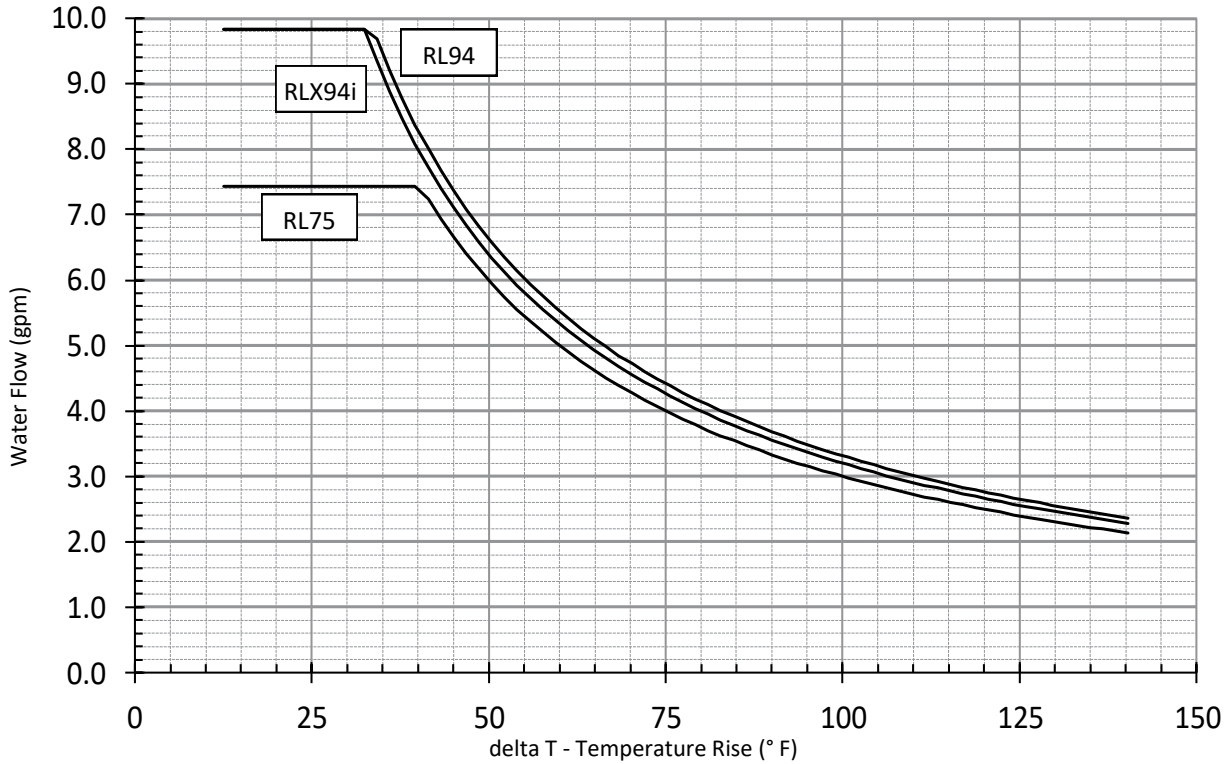

PRESSURE DROP CURVE

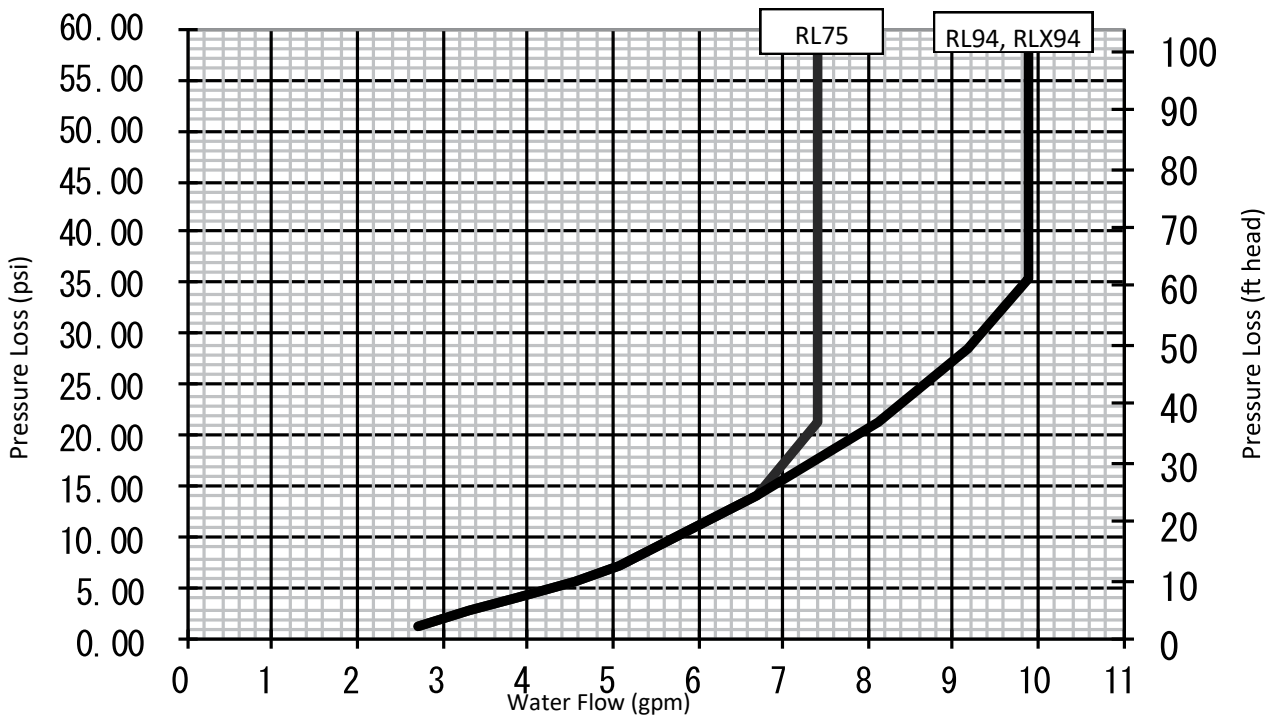

SENSEI+ CONDENSING TANKLESS
INDOOR WATER HEATERS



- Temperature controlled, continuous flow
- 0.4 GPM minimum activation rate
- Direct electronic ignition
- Direct vent, sealed combustion exhaust system (†)
- Natural gas or propane models available (††)
- Integrated condensate collector
- Circ-Logic recirculation program cycles external pump
- AC 120V, 60 Hz appliance; DC 12V remote control
- 3/4" NPT gas supply, water inlets and water outlets
- Integrated controller (#MC-91-2US)
- Isolation valve kit
- Pressure relief valve and adapter
- Thermal bypass valve on the RUR199i
- Ultra low NOx
- Tankless Rack system compatible
- 1/2" gas line compatible
- Certified for installation in manufactured (mobile) homes

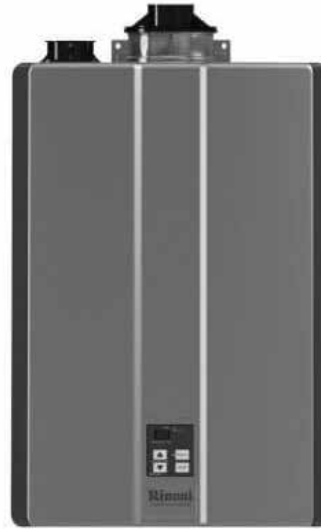

RU199i

IMPORTANT

Some Michigan jurisdictions may require a T&P valve. Check with your local inspector before installation.

We strongly recommend that you check with your local inspector before installing a tankless heater to ensure the unit will be compliant with all applicable codes. See note above regarding T&P valve.

REGISTERED RESIDENTIAL WARRANTY

- 15 year heat exchanger
- 5 year parts
- 5 year labor (◆)

REGISTERED COMMERCIAL WARRANTY

- 6 year heat exchanger
- 5 year parts
- 2 year labor (◆)

(◆) If product is not registered within 30 days of installation, labor coverage is 1 year for residential applications and 1 year for commercial applications.

ID ORDER#	MODEL#	FUEL	MBTUH INPUT MIN-MAX	DIMENSIONS W x D x H (†)	UEF
732641	RU160iN	NG	15.0-160	18.5" x 31.3" x 11.45"	0.93
733100	RU199iN	NG	15.0-199	18.5" x 31.3" x 11.45"	0.93
733104	RUR199iN	NG	15.0-199	18.5" x 31.3" x 11.45"	0.93

WHILE SUPPLIES LAST (RU199iN)

ACCESSORIES

- 740570 103000076 **LP-NG & NG-LP CONVERSION KIT**, for RU199iN, RUR199iN and RSC199iN Series; includes (2) data plates and (2) orifices
- 762661 103000080 *Same as above*, but for RU160iN, RUR160iN, CU160iN and RSC160iN Series

FOR ADDITIONAL INFORMATION, VISIT THE RINNAI WEBSITE AT www.rinnai.us

(†): Add for necessary vent clearances.

SENSEI+ CONDENSING TANKLESS
INDOOR WATER HEATERS SPECIFICATIONS



SPECIFICATIONS

		RU160i	RU199i	RUR199i
Min. gas consumption (BTU/H)		15,000	15,000	15,000
Max. gas consumption (BTU/H)		160,000	199,000	199,000
Hot water capacity (Min. - Max.)*		0.26 - 8.0 GPM (1.0 - 30.0 L/min)	0.26 - 9.8 GPM (1.0 - 37.0 L/min)	0.26 - 9.8 GPM (1.0 - 37.0 L/min)
Temperature setting (no controller)		120°F or 140°F		
Max. temperature setting (residential) (†)		Selectable at 120°F or at 140°F		
Max. temperature setting (MCC-91 controller)		140°F with parameter adjustment		
Min. temperature setting		98°F	98°F	98°F/120°F crossover mode
Energy factor		0.95	0.96	0.96
Noise level		47 dB	48 dB	49 dB
Electrical data	Normal	52 W	84 W	84 W
	Standby	1.3 W		
	Anti-frost protection	148 W	148 W	160W
	Maximum current	4 AMPS		
	Fuse	10 AMPS		
By-pass control		Electronic		
Gas supply pressure	Natural gas	3.5 - 10.5 inch W.C.		
	Propane	8.0 - 13.5 inch W.C.		
Type of appliances		Direct vent, tankless, temperature controlled continuous flow gas hot water sys.		
Connections		Gas supply/cold water inlet/hot water outlet: 3/4" NPT; condensate drain: 1/2" NPT		
Ignition system		Direct electronic ignition		
Electric connections		Appliance: AC 120V, 60 Hz; temperature controller: DC 12V (digital)		
Water temperature control		Simulated feed forward and feedback		
Min. water supply pressure		50 PSI (recommended 60-80 PSI for max. performance)		
Max. water supply pressure		150 PSI		
Temperature control cable		Non-polarized two core cable (min. 22 AWG)		
Energy Star qualified		Yes		
Certified for installation in manufactured homes		Yes		

(†) Temperatures above 140°F require MCC-91-2W commercial controller

* Minimum flow may vary slightly depending on the temperature setting and the inlet water temperature. Minimum activation flow is 0.4 GPM (1.5 L/min).

The maximum inlet gas pressure must not exceed the value specified by the manufacturer. The minimum value listed is for the purpose of input adjustment.

SENSEI+ CONDENSING TANKLESS
INDOOR WATER HEATERS SPECIFICATIONS



RU160iN and RU199iN WATER FLOW CURVE

Flow curves apply only to incoming water temperatures of 70° F (21° C) or less.
For incoming water temperatures greater than 70° F (21° C), please contact Rinnai.

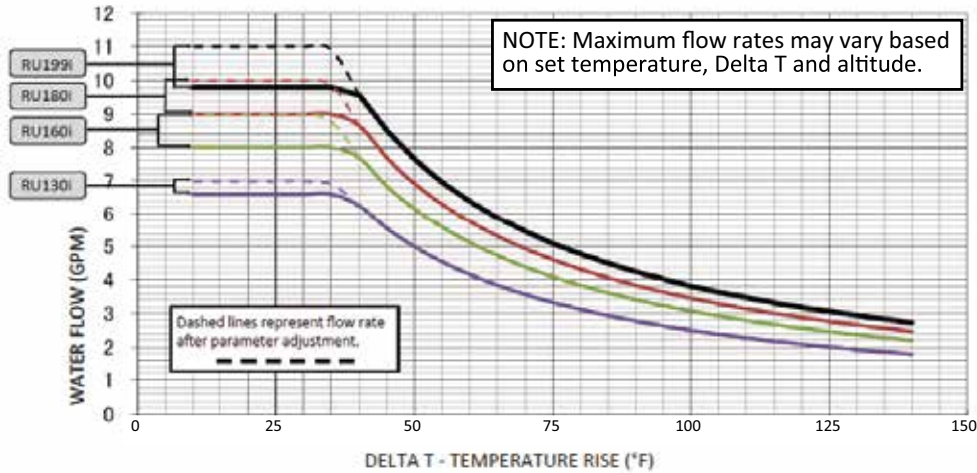

RUR199iN WATER FLOW CURVE

Flow curves apply only to incoming water temperatures of 70° F (21° C) or less.
For incoming water temperatures greater than 70° F (21° C), please contact Rinnai.

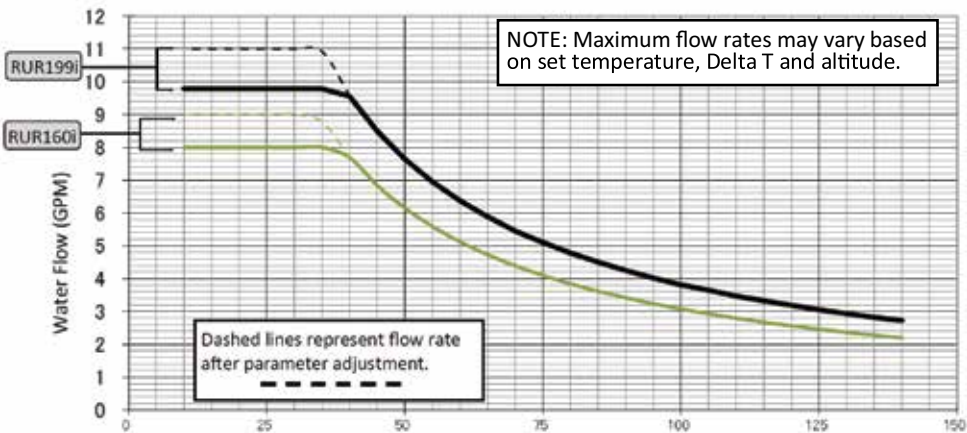

SENSEI+ CONDENSING TANKLESS
INDOOR WATER HEATERS



- Smart-Circ intelligent recirculation “learns” hot water patterns to schedule recirculation
- Temperature controlled, continuous flow
- 0.4 GPM minimum activation rate
- Direct electronic ignition
- Direct vent, sealed combustion exhaust system (†)
- Natural gas or propane models available (††)
- Integrated condensate collector
- Circ-Logic recirculation program cycles external pump
- AC 120V, 60 Hz appliance; DC 12V remote control
- 3/4” NPT gas supply, water inlets and water outlets
- Integrated controller (#MC-91-2US)
- Isolation valve kit
- Pressure relief valve and adapter
- Thermal bypass valve
- Ultra low NOx
- Tankless Rack system compatible
- 1/2” gas line compatible
- Certified for installation in manufactured (mobile) homes

IMPORTANT

Some Michigan jurisdictions may require a T&P valve. Check with your local inspector before installation.

We strongly recommend that you check with your local inspector before installing a tankless heater to ensure the unit will be compliant with all applicable codes. See note above regarding T&P valve.

REGISTERED RESIDENTIAL WARRANTY

- 15 year heat exchanger
- 5 year parts
- 5 year labor (◆)

REGISTERED COMMERCIAL WARRANTY

- 8 year heat exchanger
- 5 year parts
- 2 year labor (◆)

(◆) If product is not registered within 30 days of installation, labor coverage is 1 year for residential applications and 1 year for commercial applications.

ID ORDER#	MODEL#	FUEL	MBTUH INPUT MIN-MAX	UEF
762121	RSC199iN	NG	15.0-199	0.93

ACCESSORIES

740570 103000076 **LP-NG & NG-LP CONVERSION KIT**, for RU199iN, RUR199iN and RSC199iN Series; includes (2) data plates and (2) orifices

FOR ADDITIONAL INFORMATION, VISIT THE RINNAI WEBSITE AT www.rinnai.us

(†): Add for necessary vent clearances.

SENSEI+ CONDENSING TANKLESS
INDOOR WATER HEATERS SPECIFICATIONS



SPECIFICATIONS

		RSC199i
Min. gas consumption (BTU/H)		15,000
Max. gas consumption (BTU/H)		199,000
Hot water capacity (Min. - Max.)*		0.26 - 9.8 GPM (1.0 - 37.0 L/min)
Temperature setting (no controller)		120°F or 140°F
Max. temperature setting (residential) (†)		Selectable at 120°F or at 140°F
Max. temperature setting (MCC-91 controller)		140°F with parameter adjustment
Min. temperature setting		98°F/120°F crossover mode
Energy factor		0.93
Noise level		53 dB
Electrical data	Normal	78 W
	Standby	2.3 W
	Anti-frost protection	150 W
	Maximum current	4 AMPS
	Fuse	10 AMPS
By-pass control		Electronic
Gas supply pressure	Natural gas	3.5 - 10.5 inch W.C.
	Propane	8.0 - 13.5 inch W.C.
Type of appliances		Direct vent, tankless, temperature controlled continuous flow gas hot water sys.
Connections		Gas supply/cold water inlet/hot water outlet: 3/4" NPT; condensate drain: 1/2" NPT
Ignition system		Direct electronic ignition
Electric connections		Appliance: AC 120V, 60 Hz; temperature controller: DC 12V (digital)
Water temperature control		Simulated feed forward and feedback
Min. water supply pressure		50 PSI (recommended 60-80 PSI for max. performance)
Max. water supply pressure		150 PSI
Temperature control cable		Non-polarized two core cable (min. 22 AWG)
Energy Star qualified		Yes
Certified for installation in manufactured homes		Yes

(†) Temperatures above 140°F require MCC-91-2W commercial controller

* Minimum flow may vary slightly depending on the temperature setting and the inlet water temperature. Minimum activation flow is 0.4 GPM (1.5 L/min).

The maximum inlet gas pressure must not exceed the value specified by the manufacturer. The minimum value listed is for the purpose of input adjustment.

SENSEI+ CONDENSING TANKLESS
INDOOR WATER HEATERS SPECIFICATIONS



RSC199iN WATER FLOW CURVE



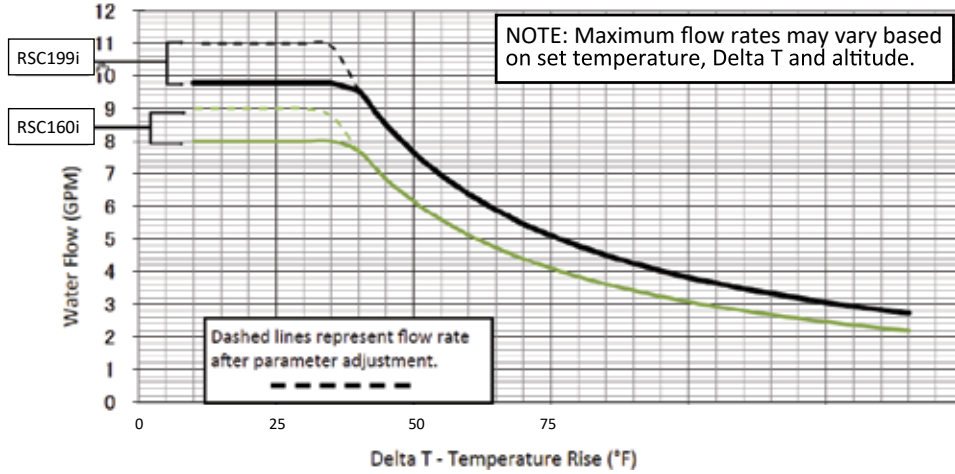





Flow curves apply only to incoming water temperatures of 70° F (21° C) or less.
For incoming water temperatures greater than 70° F (21° C), please contact Rinnai.



RINNAI

ACCESSORIES & VENTING



	ID ORDER#	MODEL#	DESCRIPTION
ACCESSORIES			* = SPECIAL ORDER ITEM
	738818	REU-EZC-2	EZ CONNECT CABLE , for RU and CU Sensei models, connects two units together, 1 required for each additional unit
	587138	MCC-91-2W	CONTROLLER—COMMERCIAL , for temperatures 140°F and above, 1 required only
VENTING			
	247820	189550	FLASHING , 1/12 to 6/12 pitch, polymer rubber
	247822	189951	Same as above, 6/12 to 12/12 pitch
	247818	169044	PIPE CLAMP
	655412 *	223184	TERMINATION — HORIZONTAL , 21" universal, <u>non-condensing</u>
	247819	184118-S	TERMINATION — VERTICAL , roof discharge (18" above roof), non-condensing
	655371	223182	TERMINATION KIT—HORIZONTAL , 21" universal, <u>non-condensing</u> , for RL75 and RL94 Series
	638886	223177PP	TERMINATION KIT—HORIZONTAL , 21" universal, <u>condensing</u> , for RU and RUR Series (3/5—3" inside pipe, 5" outside pipe)
	249082	224050	VENT ELBOW , 45°, non-condensing, set of 2
	247814	224063	VENT ELBOW , 90°, non-condensing
	247810 *	224051	VENT PIPE EXTENSION , 10"
	247812 *	224052	Same as above, but 19.5"
	247813 *	224053	Same as above, but 39"

FOR ADDITIONAL INFORMATION, VISIT THE RINNAI WEBSITE AT www.rinnai.us

UPONOR

HEPEX TUBING & ACCESSORIES



- *Cross-linked polyethylene, flexible heat transfer tubing with co-extruded oxygen diffusion barrier*
- *Rated for a maximum working pressure/temperature 160 psi at 73.4°F, 100 psi at 180°F, and 80 psi at 200°F*
- *Maximum temperature and pressure ratings in accordance to ASTM F1960 standards*
- *Linear expansion rate of 1.1"/10°F per 100 feet*
- *Used in residential and commercial applications*



ID ORDER#	MODEL#	SIZE	ID	OD	CONTENTS OF PIPE (GAL/FT)
161096	A1180313	5/16" x 250'	0.292"	0.430"	0.0024
161098	A1220313	5/16" x 1000'	0.292"	0.430"	0.0024
173646	A1250500	1/2" x 300'	0.475"	0.625"	0.0098
173647	A1220500	1/2" x 1000'	0.475"	0.625"	0.0098
57148	A1250625	5/8" x 300'	0.574"	0.750"	0.0134
61927	A1220625	5/8" x 1000'	0.574"	0.750"	0.0134

FOR ADDITIONAL INFORMATION, VISIT THE UPONOR WEBSITE AT www.uponor-usa.com

UPONOR MANIFOLD ASSEMBLIES



- *Stainless steel assembly*
- *1-1/4" ID*
- *Mounting brackets*
- *Isolation valves*
- *Balancing valves*
- *Fill/purge ports*
- *Air vents*
- *Ball valves*
- *Temperature gauges*
- *End caps*
- *Manifold adapters and fittings are sold separately*

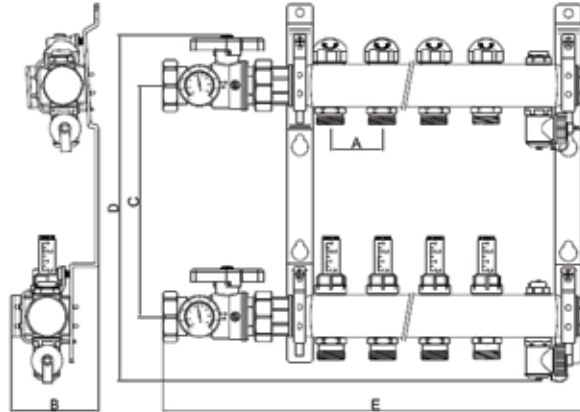

NOTE

The 2-7 loop manifolds have a 1" NPT thread-on ball valve and the 8-12 loop manifolds have a 1-1/4". An NPT x NPT reducing coupling may be required to adapt the ball valve to distribution piping.

ID ORDER#	MODEL#	DESCRIPTION
693955	A2720202	2 LOOP MANIFOLD ASSEMBLY , <u>add for required 4 fittings</u>
693956	A2720302	3 LOOP MANIFOLD ASSEMBLY , <u>add for required 6 fittings</u>
693957	A2720402	4 LOOP MANIFOLD ASSEMBLY , <u>add for required 8 fittings</u>
693958	A2720502	5 LOOP MANIFOLD ASSEMBLY , <u>add for required 10 fittings</u>
693959	A2720602	6 LOOP MANIFOLD ASSEMBLY , <u>add for required 12 fittings</u>
693960	A2720702	7 LOOP MANIFOLD ASSEMBLY , <u>add for required 14 fittings</u>
693961	A2720802	8 LOOP MANIFOLD ASSEMBLY , <u>add for required 16 fittings</u>
693962	A2721002	10 LOOP MANIFOLD ASSEMBLY , <u>add for required 20 fittings</u>
693963 *	A2721202	12 LOOP MANIFOLD ASSEMBLY , <u>add for required 24 fittings</u>
173649	A4020500	QS COMPRESSION FITTING ASSEMBLY , 1/2" connects PEX tubing products to manifold outlets
80959	A4020625	<i>Same as above</i> , but 5/8"
161102	A4020313	<i>Same as above</i> , but 5/16" (used for Quik Trak® system)
466905	Q4020500	PROPEX FITTING ASSEMBLY , 1/2", R20 thread
579033	Q4020625	<i>Same as above</i> , but 5/8"

*** = SPECIAL ORDER ITEM**

FOR ADDITIONAL INFORMATION, VISIT THE UPONOR WEBSITE AT www.uponor-usa.com

UPONOR

FITTINGS & ACCESSORIES



ID ORDER#	MODEL#	DESCRIPTION
80964	A4332075	ADAPTER , R20 x 3/4" CU, used to transition PEX tubing to 3/4" copper pipe
87679	--	ADAPTER KIT—MALE 1/2" , consists of #A4322050 R20 x 1/2" NPT conversion nipple and #A4020625 5/8" compression fitting assembly; adapts Uponor to 1/2" M.I.P. connection
87684	--	ADAPTER KIT—MALE 3/4" , consists of #A4322075 R20 x 3/4" NPT conversion nipple and #A4020625 5/8" compression fitting assembly; adapts Uponor to 3/4" M.I.P. connection
87689	--	ADAPTER KIT—SWEAT 3/4" , consists of #A4332075 R20 x 3/4" CU adapter and #A4020625 5/8" compression fitting assembly; adapts Uponor to 3/4" copper pipe connection
711502	A3019900	ADAPTER RING VA33 , for thermal actuators; allows compatibility with older style manifolds
124782	A2400032	BASIC END CAP GASKET , for brass end cap <u>less vent</u>
173650	A4160500	COMPRESSION RING , 1/2", for use with hePEX and PEX
80965	A4160625	<i>Same as above</i> , but connects 5/8"
80958	A4322050	CONVERSION NIPPLE , R20 x 1/2" NPT
80960	A4322075	<i>Same as above</i> , but R20 x 3/4" NPT
87654	A2080020	MANIFOLD LOOP END CAP , for 1-1/4" manifold loop outlets, includes (1) cap and (1) gasket
29154	A2620005	REPLACEMENT BASIC END CAP , for brass end cap <u>with vent</u>
693972	A2771060	SPACER RING VA10 , for #A3023522 thermal actuator to fit stainless steel manifold

FOR ADDITIONAL INFORMATION, VISIT THE UPONOR WEBSITE AT www.uponor-usa.com

UPONOR

FITTINGS & ACCESSORIES



ID ORDER#	MODEL#	DESCRIPTION
--------------	--------	-------------

REPAIR COUPLING KITS

216373	--	PLASTIC REPAIR COUPLING KIT, 1/2" , includes (1) #Q4775050 1/2" plastic coupling and (2) 1/2" white #Q4690502 plastic rings with blue writing (Note: plastic repair coupling kits require a special installation tool.)
215094	--	PLASTIC REPAIR COUPLING KIT, 5/8" , includes (1) #Q4776363 plastic coupling and (2) 5/8" white #Q4680625 plastic rings with black writing (Note: plastic repair coupling kits require a special installation tool.)
245210	--	BASS REPAIR COUPLING KIT, 5/16" , includes (1) #A4322020 brass coupling nipple and (2) #A4020313 5/16" QS fitting assemblies (Note: brass repair coupling kits do not require a special installation tool.)
218029	--	BASS REPAIR COUPLING KIT, 1/2" , includes (1) #A4322020 brass coupling nipple and (2) #A4020500 1/2" QS fitting assemblies (Note: brass repair coupling kits do not require a special installation tool.)
87687	--	BASS REPAIR COUPLING KIT, 5/8" , includes (1) #A4322020 brass coupling nipple and (2) #A4020625 5/8" QS fitting assemblies (Note: brass repair coupling kits do not require a special installation tool.)

REPAIR KIT COMPONENTS

161102	A4020313	COMPRESSION FITTING ASSEMBLY , with o-ring, connects 5/16" PEX tubing to manifold outlet
173649	A4020500	<i>Same as above</i> , but connects 1/2" PEX tubing to manifold outlet
80959	A4020625	<i>Same as above</i> , but connects 5/8" PEX tubing to manifold outlet
80961	A4322020	COUPLING NIPPLE , for 5/8" and 1/2" R20 fitting
196282	Q4516375	PROPEX ADAPTER , for 5/8" x 3/4" copper pipe
202976	Q4690512	PROPEX RING WITH STOP , 1/2" white with blue writing
209647	Q4690625	<i>Same as above</i> , but 5/8" and white with black writing
209653	Q4775050	REPAIR COUPLING , 1/2" plastic
215980	Q4776363	<i>Same as above</i> , but 5/8"

FOR ADDITIONAL INFORMATION, VISIT THE UPONOR WEBSITE AT www.uponor-usa.com

UPONOR

FITTINGS & ACCESSORIES



ID ORDER#	MODEL#	DESCRIPTION	* = SPECIAL ORDER ITEM
--------------	--------	-------------	------------------------

CONTROLS

248023	A3023522	THERMAL ACTUATOR , slow-opening, 24V, 4-wire, mounts directly onto TruFLOW valved manifolds, provides individual loop flow control on a multi-zoned manifold, includes end switch. DO NOT MOUNT UPSIDE DOWN!	
--------	----------	--	--

STAPLES, FASTENERS & PLATES

41593	A7031000	6" FIXING WIRE , galvanized steel tie used to secure PEX tube to wire mesh or rebar, package of 1000	
136102	F7051258	PEX CLIP , for 1/2" and 5/8", secures tube to underside of wood flooring for joist heating installations, package of 100	
234296	A5500500	PVC BEND SUPPORT (ELBOW) , 3/4", for 3/8" and 1/2" PEX, provides rigid 90° bend and sleeve, for in-ground, through-slab installations	
636640	A5500625	Same as above, but 1" PVC for 5/8" PEX	
193512	A5500750	Same as above, but 1-1/4" PVC for 3/4" PEX	
234304	A5501000	Same as above, but 1-1/2" PVC for 1" PEX	
693967	A7012000	STAPLES—BLUE FOAM , 2", for E6025000 PEX stapler to secure 3/8", 1/2", 5/8" and 3/4" PEX or 1/2" and 5/8" multi-layer composite tubing to foam board insulation, package of 300	

TOOLS



29169	E6090005	FIXING WIRE TWISTER , used with fixing wire #A7031000	
-------	----------	--	--



693966 *	E6025000	PEX FOAM STAPLER	
----------	----------	-------------------------	--

**R. A. TOWNSEND CO. RENTS SELECT UPONOR
INSTALLATION TOOLS—CONTACT OUR OFFICE FOR DETAILS
FOR ADDITIONAL INFORMATION, VISIT THE UPONOR WEBSITE AT www.uponor-usa.com**

UPONOR JOIST TRAK HEAT TRANSFER PANELS



- 1/2" extruded aluminum heat transfer plates
- 4" wide x 48" long
- For use in floor, wall and ceiling applications
- Available for 3/8" or 1/2" hePEX plus tubing
- 0.675" overall height; 0.640" internal channel diameter; 0.050" wall thickness
- Installs from below the subfloor to avoid altering floor construction
- 4' lengths can be cut on the jobsite to fit any space
- Easy to install—fasten the Joist Trak and snap in the tubing
- Self-supporting design does not require additional fasteners for tubing runs



ID	MODEL#	DESCRIPTION	
211123 *	A5080500	JOIST TRAK, 1/2", box of 20 (required #8 screws are not included)	* = SPECIAL ORDER ITEM

FOR ADDITIONAL INFORMATION, VISIT THE UPONOR WEBSITE AT www.uponor-usa.com



Below subfloor installation

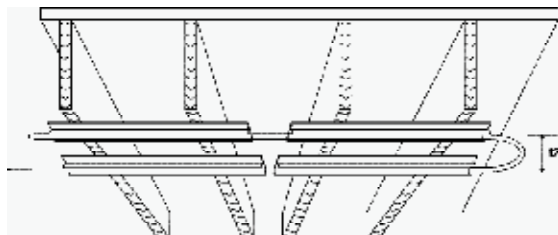

Ceiling installation

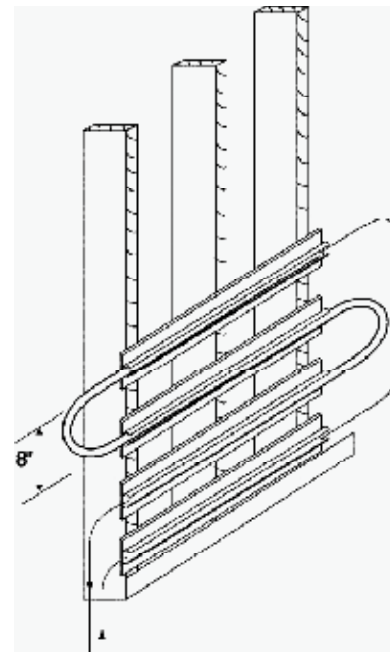

Wall installation

UPONOR QUIK TRAK PANELS & ACCESSORIES



- A patented, preassembled system of six wood panels fastened together with reinforced strapping tape and attached to an aluminum transfer sheet
- A groove down the center of each panel holds the 5/16" hePEX plus tubing
- Specially-designed Return Traks with a "U" groove complete the tubing returns

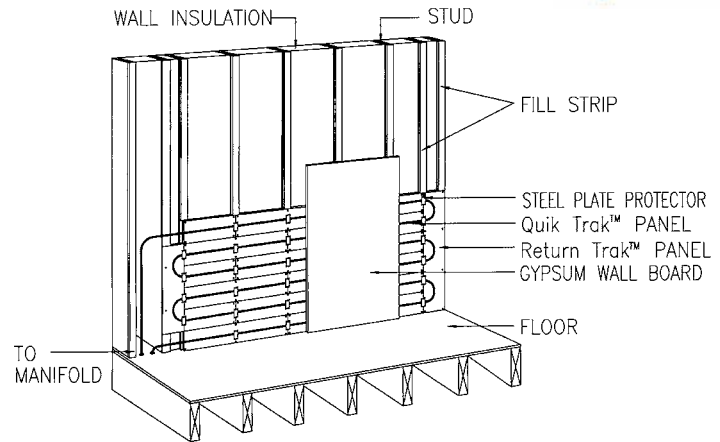

Quik Trak in the wall

ID ORDER#	MODEL#	DESCRIPTION
202969	A5060761	QUIK TRAK PANELS , 7" x 48", consisting of six pre-assembled panels
153400	A5060702	RETURN TRAK PANELS , 7" x 48", package of 10

ACCESSORIES

161103	A4160313	COMPRESSION RING , 5/16", for Quik Trak panels
161339	A4021116	O-RING , for R20 QS-style insert, package of 10
161106	E6051250	SCREWS , 2500 per package, for Quik Trak panels
161104	E6050010	SEALANT , 10.3 oz., for Quik Trak panels

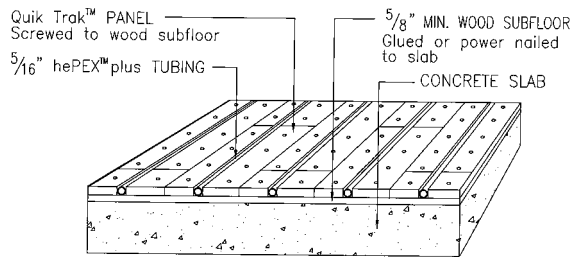

Quik Trak over concrete floor

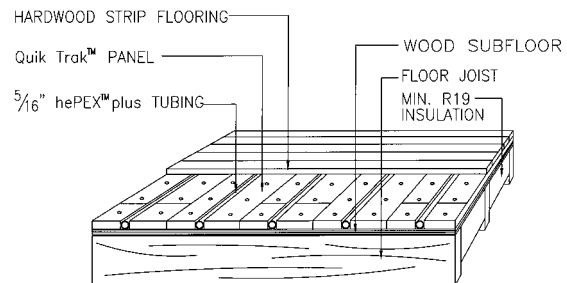

Quik Trak over wood subfloor

FOR hePEX™ TUBING, MANIFOLDS & ACCESSORIES, SEE PAGES 405 AND 405.1
FOR ADDITIONAL INFORMATION, VISIT THE UPONOR WEBSITE AT www.uponor-usa.com

REHAU

RAUPEX O₂ BARRIER PIPE



- Cross-linked polyethylene tubing with a co-extruded oxygen diffusion barrier
- Rated for a maximum working pressure/temperature of 160 psi at 73.4°F, 100 psi at 180°F, and 80 psi at 200°F
- Maximum temperature and pressure ratings in accordance to ASTM F876 standards
- Specifically designed for use with the EVERLOC+ compression-sleeve system certified to ASTM F877
- Used in residential and commercial applications



ID ORDER#	MODEL#	SIZE	COLOR	PIPE ID	PIPE OD	CAPACITY (GAL/FT)
RAUPEX O₂ BARRIER PIPE—COILS						
						* = SPECIAL ORDER ITEM
569568 *	136008-500	3/8" x 500'	Red	0.430	0.500	0.0050
569569 *	136008-000	3/8" x 1000'	Red	0.430	0.500	0.0050
569570	136031-300	1/2" x 300'	Red	0.555	0.625	0.0098
569571 *	136031-500	1/2" x 500'	Red	0.555	0.625	0.0098
569572	136031-000	1/2" x 1000'	Red	0.555	0.625	0.0098
745539	136880-300	5/8" x 300'	Red	0.667	0.750	0.0134
569573	136880-400	5/8" x 400'	Red	0.667	0.750	0.0134
745540 *	136880-500	5/8" x 500'	Red	0.667	0.750	0.0134
569574	136880-000	5/8" x 1000'	Red	0.667	0.750	0.0134
569575	136051-100	3/4" x 100'	Red	0.778	0.875	0.0189
734114 *	136051-300	3/4" x 300'	Red	0.778	0.875	0.0189
569576	136051-500	3/4" x 500'	Red	0.778	0.875	0.0189
569577	136051-000	3/4" x 1000'	Red	0.778	0.875	0.0189
569578	136011-100	1" x 100'	Red	1.000	1.125	0.0316
569579 *	136011-500	1" x 500'	Red	1.000	1.125	0.0316
569580	136283-100	1-1/4" x 100'	Red	1.222	1.375	0.0467
745542 *	136283-111	1-1/4" x 1000'	Red	1.222	1.375	0.0467
569581 *	136293-100	1-1/2" x 100'	Red	1.444	1.625	0.0650
569582 *	136303-100	2" x 100'	Red	1.889	2.125	0.1114

RAUPEX O₂ BARRIER PIPE—STRAIGHT LENGTHS

569583	136051-020	3/4" x 20'	Red	0.778	0.875	0.0189
569584	136011-020	1" x 20'	Red	1.000	1.125	0.0316
569585	136283-020	1-1/4" x 20'	Red	1.222	1.375	0.0467
569586	136293-020	1-1/2" x 20'	Red	1.444	1.625	0.0650
569587 *	136303-020	2" x 20'	Red	1.889	2.125	0.1114

FOR ADDITIONAL INFORMATION, VISIT THE REHAU WEBSITE AT www.rehau.com

REHAU

RAUPEX UV SHIELD NON-BARRIER PIPE



- Cross-linked polyethylene tubing with a co-extruded PE shield
- Protects against ultraviolet light for one year
- Rated for a maximum working pressure/temperature 160 psi at 73.4°F, 130 psi at 120°F, 100 psi at 180°F, and 80 psi at 200°F
- Maximum temperature and pressure ratings in accordance to ASTM F876 standards
- Specifically designed for use with the EVERLOC+ compression-sleeve system certified to ASTM F877
- Used in residential and commercial applications



ID ORDER#	MODEL#	SIZE	COLOR	PIPE ID	PIPE OD	CAPACITY (GAL/FT)
RAUPEX UV SHIELD NON-BARRIER PIPE—STRAIGHT LENGTHS						
745030	235351-021	1/2" x 20'	Blue	0.555	0.625	0.0098
745033	235351-022	1/2" x 20'	Red	0.555	0.625	0.0098
745026	235351-023	1/2" x 20'	White	0.555	0.625	0.0098
745029	235371-021	3/4" x 20'	Blue	0.778	0.875	0.0189
745032	235371-022	3/4" x 20'	Red	0.778	0.875	0.0189
745027	235371-023	3/4" x 20'	White	0.778	0.875	0.0189
745173	235381-021	1" x 20'	Blue	1.000	1.625	0.0650
745031	235381-022	1" x 20'	Red	1.000	1.625	0.0650
745342	235381-023	1" x 20'	White	1.000	1.625	0.0650
745339	132571-023	1-1/4" x 20'	White	1.222	1.375	0.0467
745025	132581-023	1-1/2" x 20'	White	1.444	1.625	0.0650
745028	132591-023	2" x 20'	White	1.889	2.125	0.1114

REHAU PRO-BALANCE MANIFOLDS



- *Stainless steel assembly*
- *1" NPT supply and return manifold isolation valves with gaskets and mini thermometers*
- *Visual flow gauges/isolation valves on stainless steel supply header*
- *Air vent drain valves with gaskets*
- *Mounting brackets*
- *Vent key and holder*
- *Pre-assembled and ready to install*
- *Use with 3/8", 1/2", 5/8" and 3/4" RAUPEX pipe*
- *Compatible with Rehau manifold valve actuator*
- *Manifold fittings and accessories sold separately*

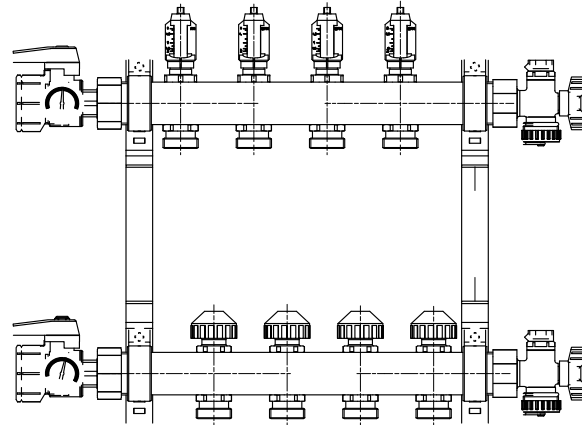

ID	MODEL#	DESCRIPTION
----	--------	-------------

PRO-BALANCE 1" STAINLESS STEEL MANIFOLDS

* = SPECIAL ORDER ITEM

741252	381101-001	1-LOOP MANIFOLD , 1", <u>add for fittings</u>
741146	381102-001	2-LOOP MANIFOLD , 1", <u>add for fittings</u>
741227	381103-001	3-LOOP MANIFOLD , 1", <u>add for fittings</u>
740644	381104-001	4-LOOP MANIFOLD , 1", <u>add for fittings</u>
741145	381105-001	5-LOOP MANIFOLD , 1", <u>add for fittings</u>
740792	381106-001	6-LOOP MANIFOLD , 1", <u>add for fittings</u>
741228	381107-001	7-LOOP MANIFOLD , 1", <u>add for fittings</u>
741229	381108-001	8-LOOP MANIFOLD , 1", <u>add for fittings</u>
741249 *	381109-001	9-LOOP MANIFOLD , 1", <u>add for fittings</u>
741230 *	381110-001	10-LOOP MANIFOLD , 1", <u>add for fittings</u>
741250 *	381111-001	11-LOOP MANIFOLD , 1", <u>add for fittings</u>
741251 *	381112-001	12-LOOP MANIFOLD , 1", <u>add for fittings</u>
775363	343381-001	9-LOOP MANIFOLD , 1-1/2", <u>add for fittings</u>
775364	343382-001	10-LOOP MANIFOLD , 1-1/2", <u>add for fittings</u>

MANIFOLD OUTLET FITTINGS

741147 *	418315-001	MANIFOLD OUTLET FITTING , 3/8", nickel plated, RaupeX x R20
740645	418317-001	Same as above, but 1/2"
741231	418318-001	Same as above, but 5/8" (= #267557-101)
741255	418319-001	Same as above, but 3/4"

MANIFOLD ACCESSORIES



569632	250209-001	CIRCUIT OUTLET CAP WITH GASKET , R20, for 1" and 1-1/4" Pro-Balance manifolds
569924 *	260166-001	VALVE ACTUATOR , 4-wire, for 1" and 1-1/4" Pro-Balance manifolds
742471 *	267007-101	OUTLET CONNECTORS , 3/4", RaupeX x R20, 1 bag/2 connectors
741259 *	316248-002	END CAP WITH GASKET , 1", stainless steel/nickel plated

FOR ADDITIONAL INFORMATION, VISIT THE REHAU WEBSITE AT www.rehau.com

REHAU

EVERLOC+ COMPRESSION SLEEVES & COUPLINGS





	ID ORDER#	MODEL#	DESCRIPTION	CTN QTY
EVERLOC+ PEXa COMPRESSION SLEEVES				* = SPECIAL ORDER ITEM
	745319 *	104815-001	EVERLOC+ PEXa COMPRESSION SLEEVE, 3/8"	50
	745052	104816-001	<i>Same as above, but 1/2"</i>	400
	745332	104817-001	<i>Same as above, but 5/8"</i>	50
	744948	104818-001	<i>Same as above, but 3/4"</i>	150
	744947	104819-001	<i>Same as above, but 1"</i>	80
	744946	104820-001	<i>Same as above, but 1-1/4"</i>	50
	744945	104821-001	<i>Same as above, but 1-1/2"</i>	30
	745051	104822-001	<i>Same as above, but 2"</i>	15
	EVERLOC+ COUPLINGS			
	745422 *	317138-001	EVERLOC+ <u>STRAIGHT</u> COUPLING—LEAD-FREE BRASS, 3/8" x 3/8"	100
	745360	317142-001	<i>Same as above, but 5/8" x 5/8"</i>	40
	745023	104824-001	EVERLOC+ <u>STRAIGHT</u> COUPLING—POLYMER, 1/2" x 1/2"	10
	745022	104825-001	<i>Same as above, but 3/4" x 3/4"</i>	10
	744943	104826-001	<i>Same as above, but 1" x 1"</i>	10
	744932	104827-001	<i>Same as above, but 1-1/4" x 1-1/4"</i>	1
	744927	104828-001	<i>Same as above, but 1-1/2" x 1-1/2"</i>	1
	745020	104829-001	<i>Same as above, but 2" x 2"</i>	1
	745366	426294-001	EVERLOC+ <u>REDUCER</u> COUPLING—LEAD-FREE BRASS, 3/4" x 5/8"	20
	745036	426297-001	<i>Same as above, but 1" x 1/2"</i>	10
	745382	425026-001	<i>Same as above, but 1-1/4" x 3/4"</i>	10
	745042	425028-001	<i>Same as above, but 1-1/2" x 3/4"</i>	6
	744925	422233-001	<i>Same as above, but 1-1/2" x 1-1/4"</i>	6
	745423	425029-001	<i>Same as above, but 2" x 1/2"</i>	2
	745424	425031-001	<i>Same as above, but 2" x 3/4"</i>	2
	745425	317139-001	<i>Same as above, but 2" x 1"</i>	2
	745426	317140-001	<i>Same as above, but 2" x 1-1/4"</i>	2
	745427	317141-001	<i>Same as above, but 2" x 1-1/2"</i>	2
	745015	104830-001	EVERLOC+ <u>REDUCER</u> COUPLING—POLYMER, 3/4" x 1/2"	10
	744924	104831-001	<i>Same as above, but 1" x 3/4"</i>	10
	745372	104832-001	<i>Same as above, but 1-1/4" x 1"</i>	1
	745044	104833-001	<i>Same as above, but 1-1/2" x 1"</i>	1

FOR ADDITIONAL INFORMATION, VISIT THE REHAU WEBSITE AT www.rehau.com

REHAU EVERLOC+ ADAPTERS







ID ORDER#	MODEL#	DESCRIPTION	CTN QTY	
EVERLOC+ ADAPTERS				
* = SPECIAL ORDER ITEM				
	745390	317184-001	EVERLOC+ PEX TO COPPER FEMALE ADAPTER—LEAD-FREE BRASS, 1/2" x 1/2" copper female	35
	745433 *	317185-001	Same as above, but 1/2" x 1/2" copper male or 3/8" copper female	75
	745215	322835-001	Same as above, but 1/2" x 3/4" copper female	20
	745391	325164-001	Same as above, but 3/4" x 1/2" copper female	20
	744854	317187-001	Same as above, but 3/4" x 3/4" copper female	20
	745393	317189-001	Same as above, but 3/4" x 1" copper female	5
	745214	317191-001	Same as above, but 1" x 1" copper female	15
	744933	317193-001	Same as above, but 1-1/4" x 1-1/4" copper female	10
	744921	317195-001	Same as above, but 1-1/2" x 1-1/2" copper female	5
	745399	317197-001	Same as above, but 2" x 2" copper female	2
	745392	325165-001	EVERLOC+ PEX TO COPPER MALE ADAPTER—LEAD-FREE BRASS, 3/4" x 1/2" copper male	20
	745394	317186-001	Same as above, but 3/4" x 3/4" copper male	30
	745395	317190-001	Same as above, but 1" x 1" copper male	15
	745396	317192-001	Same as above, but 1-1/4" x 1-1/4" copper male	10
	745397	317194-001	Same as above, but 1-1/2" x 1-1/2" copper male	5
	745174	317196-001	Same as above, but 2" x 2" copper male	2
	746364 *	317174-001	EVERLOC+ PEX TO MPT ADAPTER—LEAD-FREE BRASS, 3/8" x 1/2" MPT	40
	745019	317171-001	Same as above, but 1/2" x 1/2" MPT	40
	746365 *	317175-001	Same as above, but 5/8" x 1/2" MPT	30
	746366 *	317176-001	Same as above, but 5/8" x 3/4" MPT or 1/2" copper female	30
	745176	317172-001	Same as above, but 3/4" x 3/4" MPT	20
	746367 *	317177-001	Same as above, but 3/4" x 1" MPT	20
	746368 *	323708-001	Same as above, but 1" x 3/4" MPT	10
	738645	317178-001	Same as above, but 1" x 1" MPT	15
	746369	317179-001	Same as above, but 1-1/4" x 1-1/4" MPT	10
	746370 *	317180-001	Same as above, but 1-1/2" x 1-1/2" MPT	5
	746371 *	317181-001	Same as above, but 2" x 2" MPT	2

FOR ADDITIONAL INFORMATION, VISIT THE REHAU WEBSITE AT www.rehau.com

REHAU

EVERLOC+ ADAPTERS, PLUGS & TEES



	ID ORDER#	MODEL#	DESCRIPTION	CTN QTY
EVERLOC+ ADAPTERS (continued)				* = SPECIAL ORDER ITEM
	745178	317173-001	EVERLOC+ <u>PEX TO FPT</u> ADAPTER—LEAD-FREE BRASS, 1/2" x 1/2" FPT	40
	745179	317182-001	Same as above, but 3/4" x 3/4" FPT	20
	745434 *	329227-001	Same as above, but 1" x 3/4" FPT	10
	745411 *	317183-001	Same as above, but 1" x 1" FPT	10
	746386 *	418463-001	EVERLOC+ <u>FEMALE SWIVEL</u> ADAPTER—LEAD-FREE BRASS, 1/2" x 1/2" NPS	25
	746387 *	418464-001	Same as above, but 3/4" x 3/4" NPS	20
	EVERLOC+ PLUGS			
	745415 *	317157-001	EVERLOC+ <u>PLUG</u>—LEAD-FREE BRASS, 5/8"	60
	745418	317158-001	Same as above, but 1-1/4"	20
	745420	317159-001	Same as above, but 1-1/2"	20
	745421	317160-001	Same as above, but 2"	10
	745414	104856-001	EVERLOC+ <u>PLUG</u>—POLYMER, 1/2"	30
	745416	104857-001	Same as above, but 3/4"	20
	745417	104858-001	Same as above, but 1"	10
	EVERLOC+ STRAIGHT TEES (A x B x C)			
	745017	104835-001	EVERLOC+ <u>STRAIGHT TEE</u>—POLYMER, 1/2" x 1/2" x 1/2"	10
	744857	104836-001	Same as above, but 3/4" x 3/4" x 3/4"	10
	745004	104837-001	Same as above, but 1" x 1" x 1"	1
	745379	104838-001	Same as above, but 1-1/4" x 1-1/4" x 1-1/4"	1
	745041	104839-001	Same as above, but 1-1/2" x 1-1/2" x 1-1/2"	1
	745380	104840-001	Same as above, but 2" x 2" x 2"	1
		745428 *	317143-001	EVERLOC+ <u>RUN REDUCING TEE</u>—LEAD-FREE BRASS, 1-1/4" x 1" x 1-1/4"
745213 *		317144-001	Same as above, but 1-1/2" x 1" x 1-1/2"	2
745429 *		317145-001	Same as above, but 1-1/2" x 1-1/4" x 1-1/2"	2
745430 *		317146-001	Same as above, but 2" x 1-1/4" x 2"	1
745180 *		317147-001	Same as above, but 2" x 1-1/2" x 2"	1
745013		104841-001	EVERLOC+ <u>RUN REDUCING TEE</u>—POLYMER, 3/4" x 1/2" x 3/4"	5
745181		104842-001	Same as above, but 1" x 3/4" x 1"	5

FOR ADDITIONAL INFORMATION, VISIT THE REHAU WEBSITE AT www.rehau.com

REHAU EVERLOC+ TEES



	ID ORDER#	MODEL#	DESCRIPTION	CTN QTY
EVERLOC+ TEES (A x B x C)				
* = SPECIAL ORDER ITEM				
	745431 *	424991-001	EVERLOC+ BRANCH REDUCING TEE—LEAD-FREE BRASS, 1-1/4" x 1-1/4" x 1/2"	2
	745432	322832-001	Same as above, but 1-1/4" x 1-1/4" x 3/4"	2
	745043 *	425024-001	Same as above, but 1-1/2" x 1-1/2" x 1/2"	2
	745045	322833-001	Same as above, but 1-1/2" x 1-1/2" x 3/4"	2
	746347 *	317149-001	Same as above, but 1-1/2" x 1-1/2" x 1-1/4"	2
	745211 *	424995-001	Same as above, but 2" x 2" x 1/2"	1
	746349 *	322834-001	Same as above, but 2" x 2" x 3/4"	1
	746350 *	317150-001	Same as above, but 2" x 2" x 1-1/4"	1
	745037 *	317151-001	Same as above, but 2" x 2" x 1-1/2"	1
	745016	104844-001	EVERLOC+ BRANCH REDUCING TEE—POLYMER, 3/4" x 3/4" x 1/2"	10
	745011	104846-001	Same as above, but 1" x 1" x 1/2"	5
	744934	104845-001	Same as above, but 1" x 1" x 3/4"	5
	744930	104847-001	Same as above, but 1-1/4" x 1-1/4" x 1"	1
	744922	104848-001	Same as above, but 1-1/2" x 1-1/2" x 1"	1
	745034	104849-001	Same as above, but 2" x 2" x 1"	1
	746351	424989-001	EVERLOC+ BRANCH & RUN REDUCING TEE—LEAD-FREE BRASS, 1-1/4" x 1" x 3/4"	2
	745039	424992-001	Same as above, but 1-1/2" x 1" x 3/4"	2
	746352 *	317152-001	Same as above, but 1-1/2" x 1" x 1"	2
	746353 *	425025-001	Same as above, but 1-1/2" x 1-1/4" x 3/4"	2
	746354 *	317153-001	Same as above, but 1-1/2" x 1-1/4" x 1"	2
	746355 *	317154-001	Same as above, but 1-1/2" x 1-1/4" x 1-1/4"	2
	746356 *	424944-001	Same as above, but 2" x 1-1/2" x 3/4"	1
	746357 *	317156-001	Same as above, but 2" x 1-1/2" x 1"	1
	746358 *	317161-001	Same as above, but 2" x 1-1/2" x 1-1/4"	1
	745038 *	317155-001	Same as above, but 2" x 1-1/2" x 1-1/2"	1
	745177	104851-001	EVERLOC+ BRANCH AND RUN REDUCING TEE—POLYMER, 3/4" x 1/2" x 1/2"	10
	744942	104852-001	Same as above, but 1" x 3/4" x 3/4"	5
	744931	104853-001	Same as above, but 1-1/4" x 1" x 1"	1

EVERLOC+ BULLHEAD TEES





746373 *	104854-001	EVERLOC+ BULLHEAD TEE—POLYMER, 1/2" x 1/2" x 3/4"	10
746374	104855-001	Same as above, but 3/4" x 3/4" x 1"	5

FOR ADDITIONAL INFORMATION, VISIT THE REHAU WEBSITE AT www.rehau.com

REHAU EVERLOC+ ELBOWS



	ID ORDER#	MODEL#	DESCRIPTION	CTN QTY
EVERLOC+ 45° ELBOWS			* = SPECIAL ORDER ITEM	
	746359 *	425021-001	EVERLOC+ <u>PEX TO PEX</u> 45° ELBOW—LEAD-FREE BRASS, 1-1/2" x 1-1/2"	2
	746360 *	425022-001	Same as above, but 2" x 2"	2
EVERLOC+ BULLHEAD ELBOWS				
	744928	104862-001	EVERLOC+ <u>PEX TO PEX</u> 90° BULLHEAD ELBOW—POLYMER, 1-1/4" x 1-1/4"	1
EVERLOC+ 90° ELBOWS				
	745384 *	317163-001	EVERLOC+ <u>PEX TO PEX</u> 90° ELBOW—LEAD-FREE BRASS, 5/8" x 5/8"	50
	745018	104859-001	EVERLOC+ <u>PEX TO PEX</u> 90° ELBOW—POLYMER, 1/2" x 1/2"	15
	744855	104860-001	Same as above, but 3/4" x 3/4"	10
	744941	104861-001	Same as above, but 1" x 1"	5
	744920	104863-001	Same as above, but 1-1/2" x 1-1/2"	1
	745035	104864-001	Same as above, but 2" x 2"1	1
	746361 *	317164-001	EVERLOC+ <u>PEX TO COPPER</u> 90° ELBOW—LEAD-FREE BRASS, 1/2" x 1/2" copper male or 3/8" copper female	50
	746362 *	317165-001	Same as above, but 1/2" x 1/2" <u>copper female</u>	25
	746363 *	317166-001	Same as above, but 3/4" x 3/4" <u>copper male</u>	25
	745388	317167-001	Same as above, but 3/4" x 3/4" <u>copper female</u>	20
	746378	317170-001	EVERLOC+ <u>PEX TO FPT</u> 90° DROP-EAR ELBOW—LEAD-FREE BRASS, 1/2" x 1/2" copper female	20
	746381	422006-001	Same as above, but 3/4" x 3/4" copper female	10
	746383 *	422007-001	Same as above, but 1" x 1" copper male	10
	746379 *	317168-001	EVERLOC+ <u>PEX TO MPT</u> 90° ELBOW—LEAD-FREE BRASS, 1/2" x 1/2" copper male	20
	746380 *	317169-001	Same as above, but 3/4" x 3/4" copper female	10
	746382 *	425476-001	Same as above, but 1" x 1" copper male	10

FOR ADDITIONAL INFORMATION, VISIT THE REHAU WEBSITE AT www.rehau.com

SUPPORT CHANNELS AND BENDS,
STUB OUT ELBOWS & TOOLS



	ID ORDER#	MODEL#	DESCRIPTION	CTN QTY
GALVANIZED SUPPORT CHANNELS				* = SPECIAL ORDER ITEM
	745584	225527-001	GALVANIZED STEEL SUPPORT CHANNEL , tub of 10	1
	745585 *	225537-002	Same as above, but 1"	1
	745586 *	225547-002	Same as above, but 1-1/4"	1
	745587 *	225557-002	Same as above, but 1-1/2"	1
	745588 *	225567-002	Same as above, but 2"	1
SUPPORT BENDS & BEND GUIDES				
	566845	266207-001	PLASTIC (POLYMER) SUPPORT BEND WITH SCREW HOLE , 1/2" (=Sioux Chief #550-PB2)	50
	569858	266227-001	Same as above, but 3/4" (=Sioux Chief #550-PB3)	50
	569859	226237-001	Same as above, but 1"	50
	569863	266180-001	BEND GUIDE—SCHEDULE 40 PVC , 1"	20
CLOSED END STUB OUT ELBOWS				
	745050 *	418665-001	CLOSED END STUB OUT ELBOW , 1/2" Everloc+ (8" L)	40
	746389 *	424864-001	Same as above, but 1/2" with mounting plate	25
	746390 *	418668-001	Same as above, but 3/4" and less mounting plate	20
	746391 *	329229-001	Same as above, but 3/4" with mounting plate	20
EVERLOC+ TOOLS				
	741260 *	261016-150	PNEUMATIC STAPLER	1
	740381 *	298956-001	RAUTACKER 3D STAPLER TOOL	1
	740152	105107-003	EVERLOC+ POWER TOOL STANDARD KIT , for assembling 1/2", 3/4" and 1" Everloc+ fittings; includes power tool base unit; expander adapter QC; 1/2", 3/4" and 1" expander heads QC; 1/2", 3/4" and 1" compression jaws; (2) DeWalt 12V Li-ion batteries; DeWalt 12V/20V Li-ion battery charger, 120VAC; Raucutter; tool case; grease; cleaning brush; and operating instructions	1
	748801	105087-001	EVERLOC+ JAW SET , 5/8"	1
	748799	105075-001	EVERLOC+ EXPANDER HEAD , 5/8"	1
	744951	105733-002	EVERLOC+ XL POWER TOOL STANDARD KIT , for assembling 1-1/4", 1-1/2" and 2" Everloc+ fittings; includes XL power tool base unit; XL power tool support handle; XL expander adapter QC; 1-1/4", 1-1/2" and 2" XL expander heads QC; 1-1/4", 1-1/2" and 2" compression jaws; (2) Makita 18V Li-ion batteries; Makita 18V Li-ion battery charger, 120VAC; large ratchet cutter; tool case; grease; cleaning brush; and operating instructions	1

FOR ADDITIONAL INFORMATION, VISIT
THE REHAU WEBSITE AT www.rehau.com

REHAU

JOIST SPACE RADIANT HEATING



- 1/2" heat transfer plates for use in radiant floor heating system applications
- 4 foot long plates
- 0.032" thick aluminum
- 8" on-center pipe spacing
- Pipes snap easily and firmly into grooves without tool
- Plates are easy to cut to length
- Double plate covers more area
- Installs from below the subfloor to avoid altering floor construction
- 4' lengths can be cut on the jobsite to fit any space



ID	MODEL#	DESCRIPTION
740793	298926-001	RAUPLATE JOIST SPACE RADIANT HEATING , for 1/2" Raupex, 8" center, 20/box

FOR ADDITIONAL INFORMATION, VISIT
THE REHAU WEBSITE AT www.rehau.com

RED-WHITE VALVE CORP.

EVERLOC+ PEX BALL VALVES



- DZR lead-free brass body
- 400# WOG
- Rehau Everloc+ full port
- Barb (Everloc+) x Barb (Everloc+)
- PEX ends (Everloc+)
- Chrome-plated ball
- Virgin PTFE seats
- Blow-out proof stem
- Double NBR O-ring packing
- Rated for a maximum working pressure/temperature of 300 psi from 15°F to 160°F and 150 psi at 200°F



ID	MODEL#	DESCRIPTION
----	--------	-------------

EVERLOC+ PEX BALL VALVES

745048	5415AB	EVERLOC+ PEX BALL VALVE—LEAD-FREE BRASS, 1/2"
745047	5415AB	<i>Same as above, but 3/4"</i>
745046	5415AB	<i>Same as above, but 1"</i>
745376	5415AB	<i>Same as above, but 1-1/4"</i>
745049	5415AB	<i>Same as above, but 1-1/2"</i>
745212	5415AB	<i>Same as above, but 2"</i>

**FOR ADDITIONAL INFORMATION, VISIT THE RED-WHITE VALVE CORP.
WEBSITE AT www.redwhitevalvecorp.com**

TEKMAR CONTROLS & SENSORS



ID ORDER#	MODEL#	DESCRIPTION
BOILER CONTROLS		
173733	261	BOILER CONTROL , 2-stage, microprocessor-based, easy plug-in system, 2 boiler stages, boiler pump relay, setpoint demand input, PID staging, equal run time rotation, optional indoor air sensor, setback timer, includes #070 outdoor sensor and #071 universal sensor, digital LCD display
737854	304P	PUMP CONTROL WITH ZONE PRIORITY , 4-zones, priority override, post purge, away signal shared between Tekmar thermostats, compatible with all low voltage thermostats, CSA-approved, RoomResponse signal, LED for each zone, priority, end switch and RoomResponse, unlimited zone expansion, top, bottom and back conduit knockouts
RADIANT FLOOR CONTROLS		
173734	356	VARIABLE SPEED MIXING CONTROL , quick installer setup, useradjustable comfort setting, warm weather shut down settings, characterized heating curve, auto differential, variable speed injection, boiler protection, boiler load reset, no special pump required because variable speed output is compatible with standard wet rotor circulators (Grundfos, etc.); digital LCD display
62134	071	UNIVERSAL SENSOR , includes zinc sleeve for fast response and a wide operating range

**FOR ADDITIONAL INFORMATION, CALL OUR OFFICE OR VISIT
THE TEKMAR WEBSITE AT www.tekmarcontrols.com**

30 SERIES HYDRONIC BASEBOARD



- Pre-assembled baseboard comes with heating element, enclosure, expansion cradles, support brackets, and damper
- 2" splice plate set comes with lengths of 5' and over
- 10' assemblies contain two separate elements
- Nu-White baked enamel finish

BTU/HR RATING PER FOOT AT 65°F ENTERING AIR

Water Pressure	140°	150°	160°	170°	180°	190°	200°	210°	215°	220°	
Flow Drop											
1 GPM	47	320	380	450	510	580	640	710	770	810	840
4 GPM	525	340	400	480	540	610	680	750	810	860	890

ID ORDER#	BTU OUTPUT 4 GPM @ 180°F	LENGTH	* = SPECIAL ORDER ITEM
-----------	-----------------------------	--------	------------------------

COMPLETE ASSEMBLY with 3/4" element

189602	1220	2'
189547	1830	3'
189548	2440	4'
189549	3050	5'
189550	3660	6'
189551	4270	7'
189552	4880	8'
189603 *	5490	10'

COVER ONLY

189606 *	--	2
189607 *	--	3
189608 *	--	4
189555	--	5
189609 *	--	6
189610 *	--	7
189556	--	8
189611 *	--	10

3/4" ELEMENT ONLY

42829 *	--	2
42830 *	--	3
42831 *	--	4
42832	--	5
42833 *	--	6
42834 *	--	7
42835	--	8
49020 *	--	10

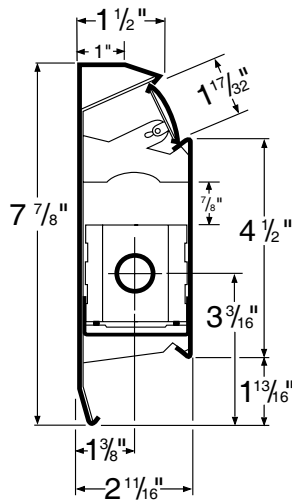

ID ORDER#	MODEL#	DESCRIPTION
189601	101-020	BRACKET , with damper pivot
189557	101-431	END CAP , 2", right hand, snap-on, non-hinged
189558	101-432	Same as above, but left hand
189559	101-410	INSIDE CORNER , 90°, snap-on, hinged
189596	101-411	Same as above, but 135°
189598	101-414	OUTSIDE CORNER , 90°, snap-on, non-hinged
189599	101-415	Same as above, but 135°
189600	101-640	SPLICE PLATE , 2", solid snap-on, non-hinged

FOR ADDITIONAL INFORMATION, VISIT THE SLANT/FIN WEBSITE AT www.slantfin.com

SLANT/FIN 80 SERIES HYDRONIC BASEBOARD



- Extra-heavy 18 gauge steel front panel
- Pre-assembled baseboard comes with heating element, enclosure, expansion cradles, support brackets, and damper
- 2" splice plate set and damper joiner comes with lengths of 5' and over
- 10' assemblies contain two separate elements
- Nu-White baked enamel finish

BTU/HR RATING PER FOOT AT 65°F ENTERING AIR											
Water Pressure	140°	150°	160°	170°	180°	190°	200°	210°	215°	220°	
Flow Drop											
1 GPM	47	--	490	570	650	730	810	890	970	1010	1050
4 GPM	525	--	520	600	690	770	860	940	1030	1070	1110

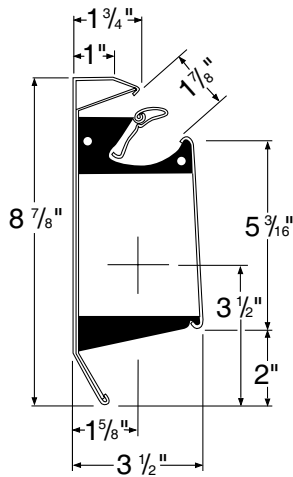

ID ORDER#	BTU OUTPUT 4 GPM @ 180°F	LENGTH
COMPLETE ASSEMBLY with 3/4" element		
189571	2310	3'
189572	3080	4'
189288	3850	5'
189285	4620	6'
189286	5390	7'
189287	6160	8'
COVER ONLY		
189573	--	5'
189574	--	8'

ID ORDER#	MODEL#	DESCRIPTION
189291	103-411	END CAP , 4", right hand, snap-on, hinged
189292	103-412	Same as above, but left hand
189612	103-413	END CAP—SLOTTED , 4", right hand, snap-on, hinged
189614	103-414	Same as above, but left hand
189289	103-417	INSIDE CORNER , 90°, snap-on, hinged
189616	103-421	OUTSIDE CORNER , 90°, snap-on, non-hinged
711048	103-433	WALL TRIM/SPLICE PLATE , 2", snap-on, non-hinged
711044	103-426	WALL TRIM , 4", snap-on, non-hinged

FOR ADDITIONAL INFORMATION, VISIT THE SLANT/FIN WEBSITE AT www.slantfin.com

SLANT/FIN 90 SERIES HYDRONIC BASEBOARD COMMERCIAL



- Single tier
- Extra-heavy 18 gauge steel front panel
- Pre-assembled baseboard comes with heating element, enclosure, expansion cradles, support brackets, and damper
- 2" splice plate set and damper joiner comes with lengths of 5' and over
- 10' assemblies contain two separate elements
- Nu-White baked enamel finish

BTU/HR RATING PER FOOT AT 65°F ENTERING AIR										
Water Pressure	140°	150°	160°	170°	180°	190°	200°	210°	215°	220°
Flow	Drop									
1 GPM	47	--	490	570	650	730	810	890	970	1010 1050
4 GPM	525	--	520	600	690	770	860	940	1030	1070 1110

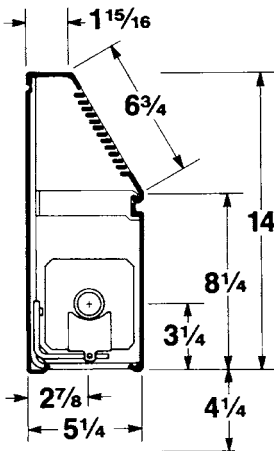

ID ORDER#	BTU OUTPUT 4 GPM @ 180°F	LENGTH
#90-14 ENCLOSURE—1 TIER		
17803	952	3'
17804	1070	4'
17805	966	5'
17806	1269	6'
17807	1346	7'
17808	1318	8'

WHILE SUPPLIES LAST

ID ORDER#	MODEL#	DESCRIPTION
17809	185-101	END CAP , 3", right hand
17810	185-102	Same as above, but left hand
17811	185-105	TELESCOPIC SPLICER , 3"
17812	185-107	INSIDE CORNER , 90°
36967	185-108	OUTSIDE CORNER , 90°

FOR ADDITIONAL INFORMATION, VISIT THE SLANT/FIN WEBSITE AT www.slantfin.com

MODINE HYDRONIC UNIT HEATERS



- Side supply and return connections
- 2-piece casing for easy coil access
- Tapped holes for suspension by threaded rod or optional pipe hanger adapter kit
- Serpentine copper tube coil design
- Female-type connections
- Aluminum die-formed fins
- Enclosed motor with built-in thermal overload protection
- Electrical junction box
- Adjustable horizontal air-deflector blades standard on all units; vertical blades standard on HC-258, 290 and 340 units (optional on other units)
- Safety fan guard
- Baked-on gray-green polyester powdercoat paint over rust- and corrosion-resistance-treated steel



ID ORDER#	MODEL #	WATER 200°F IN/60°F ENTER AIR (BTU/HR)	STEAM 2 PSI/ 60°F ENTER AIR (BTU/HR)	DIMENSIONS W x D x H	FEMALE CONN. (NPT)	MOTOR HP
HORIZONTAL DELIVERY						
625532 *	HC18SB-01SA	12,600	18,000	13" x 6" x 11-1/2"	1/2"	1/60
625535 *	HC24SB-01SA	16,200	24,000	13" x 6" x 11-1/2"	1/2"	1/25
625536 *	HC33SB-01SA	21,700	33,000	17-1/2" x 8-3/4" x 15"	3/4"	1/25
625537	HC47SB-01SA	30,900	47,000	17-1/2" x 8-3/4" x 15"	3/4"	1/12
625538	HC63SB-01SA	45,600	63,000	21-1/2" x 8-3/4" x 18-1/2"	3/4"	1/12
625539	HC86SB-01SA	60,200	86,000	21-1/2" x 8-3/4" x 18-1/2"	3/4"	1/8
625540 *	HC108SB-01SA	83,700	108,000	25-1/2" x 9-1/2" x 22-1/2"	3/4"	1/8
625541	HC121SB-01SA	93,000	121,000	25-1/2" x 9-1/2" x 22-1/2"	3/4"	1/5
625542 *	HC165SB-01SA	130,900	165,000	29-1/2" x 9-1/4" x 26-1/2"	3/4"	1/3
625543 *	HC193SB-01SA	143,000	193,000	32-1/2" x 9-1/4" x 30-1/2"	1-1/4"	1/3
625544 *	HC258SB-01SA	201,900	258,000	38-1/2" x 12-1/2" x 38-1/2"	1-1/4"	1/2
625545 *	HC290SB-01SA	228,600	290,000	38-1/2" x 12-1/2" x 38-1/2"	1-1/4"	1/2
625546 *	HC340SB-01SA	271,100	340,000	44-1/2" x 12-1/2" x 38-1/2"	1-1/4"	1/2

* = SPECIAL ORDER ITEM

FOR ADDITIONAL INFORMATION, VISIT THE MODINE WEBSITE AT www.modine.com

BEACON/MORRIS KICKSPACE HEATERS



- Fits inconspicuously under a cabinet, in the floor, or on/in the wall
- Sealed triple ball bearing construction
- 1/2" nominal 5/8 OD copper tube connections
- 115V electric blower motor
- 120°F reverse acting aquastat prevents operation until hot water is circulating
- Fins are shaped and spaced to prevent dust collection and maximize operating efficiency
- Not intended to be used on 1- or 2-pipe steam systems
- 5-year warranty



ID ORDER#	MODEL#	DESCRIPTION	* = SPECIAL ORDER ITEM
26923	K42	KICKSPACE MODEL , rated at 4470 BTU/hr (3 gpm @ 180°F); complete with grille; requires 12-1/4" W x 12-3/4" D; average outlet temperature: 130°F at 36 cfm	
26924	K84	Same as above, but rated at 8840 BTU/hr; requires 19-1/4" W x 12-3/4" D; average outlet temperature: 130°F at 72 cfm	
82202	K120	Same as above, but rated at 12045 BTU/hr; requires 19-1/4" W x 12-3/4" D; average outlet temperature: 130°F at 118 cfm	

ACCESSORIES AND PARTS

28273	BMKR02024-001	AQUASTAT ASSEMBLY , for K42 and K84, can be adapted to old (105-120°F) style units
512365	BMKR02024-002	Same as above, but for K120
26928	W42	FLUSH MOUNTING KIT , for K42 heater
26927 *	W84	Same as above, but for K84
82204	W120	Same as above, but for K120
26929	F42	SURFACE MOUNTING KIT , for K42 heater
26930	F84	Same as above, for K84
82203 *	F120	Same as above, for K120

FOR ADDITIONAL INFORMATION, VISIT THE BEACON-MORRIS WEBSITE AT www.beacon-morris.com



ID	ORDER#	PART#	MODEL#	SIZE	DESCRIPTION
----	--------	-------	--------	------	-------------

FLO CONTROL VALVES

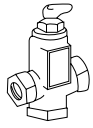

	6146	107018	SA	1"	FLOW CHECK—SCREWED ENDS , straight-angle
	6147	107019	SA	1-1/4"	Same as above
	6148	107020	SA	1-1/2"	Same as above
	6149	107021	SA	2"	Same as above, but one end flanged
	6150	107024	SB	3/4"	FLOW CHECK—SWEAT ENDS , straight through, bronze

DIFFERENTIAL BYPASS VALVES

	757262	113247	DB-3/4	3/4"	DIFFERENTIAL BYPASS VALVE , brass body
--	--------	--------	--------	------	---

PRESSURE REDUCING VALVES (PRV)

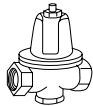

	23615	110196LF	B7-12	3/4"	PRESSURE REDUCING VALVE , brass body
	23614	110192LF	FB-38	1/2"	Same as above, but replaces FB-3 and FB-8

AIRTROL TANK FITTING



	6156	113041	DT-2	--	DRAIN-O-TANK AIR CHARGER
--	------	--------	------	----	---------------------------------

MONOFLO FITTINGS



	6158 *	108121	--	1" x 3/4"	C x C RED RING COPPER TEE (use Legend #302-205, ID #693644)
--	--------	--------	----	-----------	--

AUTOMATIC AIR VENT

	26805	97	--	1/8" NPT	AUTOMATIC HOT WATER AIR VENT , 150 psi (=Weil McLain #10C209; =Taco #400-3; =B&G #400)
--	-------	----	----	----------	--

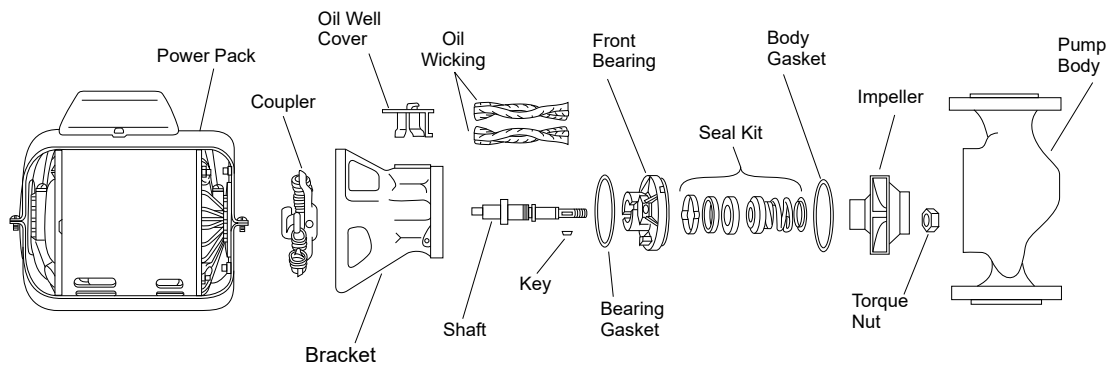





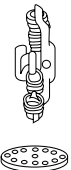

FOR ADDITIONAL INFORMATION, VISIT THE BELL & GOSSETT WEBSITE AT: www.bellgossett.com

BELL & GOSSETT

HYDRONIC PUMP REPAIR PARTS



	ID ORDER#	PART#	DESCRIPTION	ARMSTRONG EQUIVALENT	
	6323	118844LF	BEARING ASSEMBLY	816019-002	* = SPECIAL ORDER ITEM
	6331	186863LF	Same as above	816032-000	
	6335	189034LF	Same as above	--	
	6351	189105LF	Same as above	816027-002	
	158705	189162LF	Same as above	--	
	158706	189163LF	Same as above	--	
	6247 *	118339	BODY	805482-011	
	6373	P64910	BOLT & GASKET SET	--	
	6269	118473	COUPLER , cast iron	807436-000	
	6320	118709	Same as above	806137-000	
	6322	118723	Same as above	806168-002	
	6358	118705	Same as above	806026-001/806026-002	
	6201 *	118035	GASKET	--	
	6371	P57410	Same as above	--	
	25315	P57700	Same as above	--	
	6376	PO4080	Same as above	--	
	6377	PO4890	Same as above	--	
	6379	PO5800	Same as above	106050-000	
	6234	118129	GASKET SET	805201-000	
6249	118368	Same as above	805176-000		
6251	118373	Same as above	804034-000		
	6295	118668	IMPELLER , bronze	816556-011	
	6366	189132LF	IMPELLER ASSEMBLY	--	
	6378 *	PO4940	KEY	--	
	6194	111031	MOTOR , 1/6 HP	817025-001	
	6196	111061	Same as above	--	
	6236	118223	RING SET	--	
	6240	118228	Same as above	--	
30892 *	R82390	RUBBER CHECK VALVE	--		
6312	118681LF	SEAL KIT #7	816706-001		
25314	186862LF	SEAL KIT	--		
6203	118036	STRAINER	--		
	6252	118395	WICK SET	806993-000	

FOR ADDITIONAL INFORMATION, VISIT THE BELL & GOSSETT WEBSITE AT: www.bellgossett.com

TACO

STANDARD CIRCULATORS



ID ORDER#	MODEL#	DESCRIPTION
 732942	007-F5-7IFC	CARTRIDGE CIRCULATOR WITH INTEGRAL FLOW CHECK—CAST IRON, 1-speed , flanged, 115V, 60 Hz, 1 phase, .70 amps, 3250 RPM, 1/25 HP; designed for operation in hydronic heating, radiant heating, hydro-air fan coils, indirect water heating, chilled water cooling and domestic water systems
 732943	0011-F4	CARTRIDGE CIRCULATOR—CAST IRON, 1-speed , flanged, 115V, 60 Hz, 1 phase, 1.76 amps, 3250 RPM, 1/8 HP; designed for high head/medium flow applications in large residential and light commercial closed loop hydronic heating and chilled water cooling systems; use with high pressure drop boilers, fan coil units, heat exchangers, large radiant heating and heat recovery/geothermal jobs; anti-condensate baffle protects motor windings on chilled water jobs
 732944	0014-F1	CARTRIDGE CIRCULATOR—CAST IRON, 1-speed , flanged, 115V, 60 Hz, 1 phase, 1.55 amps, 3250 RPM, 1/8 HP; designed for medium head/medium flow applications in large residential and light commercial systems; ideal for large BTUH boilers, primary/ secondary loops, commercial water heaters and light commercial heating and chilled water cooling systems
 732946	0013-MSF1-IFC	CIRCULATOR WITH INTEGRAL FLOW CHECK—CAST IRON, 3-speed , flanged, 115V, 60 Hz, 1 phase, 2.15 amps, 260 watts, 3250 RPM, 1/6 HP; designed for high head/high flow large residential/light commercial hydronic heating and chilled water cooling systems; high starting torque; includes removable high-flow integral flow check
 732947	0015-MSF3-IFC	CIRCULATOR WITH INTEGRAL FLOW CHECK—CAST IRON, 3-speed , flanged, 115V, 60 Hz, 1 phase, .85 amps, 3250 RPM, 1/20 HP; designed for any hydronic heating system, including radiant and higher head systems and chilled water cooling systems; high starting torque; includes removable high-flow integral flow check

FOR TACO ENGINEERING DATA, SEE PAGES 413.3-413.7

FOR FLANGES, SEE PAGES 414, 414.1 and 415.2

FOR ADDITIONAL INFORMATION, VISIT THE TACO WEBSITE AT: www.tacocomfort.com

TACO

ECM CIRCULATORS



ID ORDER#	MODEL#	DESCRIPTION
 732954	006e3	ECM HIGH EFFICIENCY WET ROTOR CIRCULATOR—COMPOSITE, 3-speed , 120V, 60 Hz, 1 phase, 0.54 amps, 44 watts, 1440-3720 RPM, 1/40 HP; ECM permanent magnet motor and 6' power cord; 13' maximum shut-off head, 11 gpm maximum flow, 3-color LED indicator light, 1" union connection; double insulated, no ground wire required; designed for use in open loop domestic hot water recirculation or closed hydronic systems; <u>not suitable for chilled water</u> Note: add for #UFS-075T 3/4" FNPT union, ID #733151
 733719	007e-2F4	ECM HIGH EFFICIENCY WET ROTOR CIRCULATOR—CAST IRON, 1-speed , 120V, 60 Hz, 1 phase, 0.54 amps, 44 watts, 4830 RPM, 1/25 HP; universal "U" two-way flange type; with ECM permanent magnet motor, dual electric knockouts and 6" stranded wire leads; 10' maximum shut-off head, 16 gpm maximum flow, double insulated, no ground wire required; designed for use in closed loop hydronic systems zoned with circulators or zone valves
 732953	0015e3-2F4	ECM HIGH EFFICIENCY WET ROTOR CIRCULATOR—CAST IRON, 3-speed , 4-bolt flange, 120V, 60 Hz, 1 phase, 0.54 amps, 44 watts, 4830 RPM, 1/25 HP; with ECM permanent magnet motor, dual electric knockouts and 6" stranded wire leads; 3 settings: low (5' maximum shut-off head), medium (18' maximum shut-off head) and high (10' maximum shut-off head), 16 gpm maximum flow, double insulated, no ground wire required; designed for use in closed loop hydronic systems zoned with circulators or zone valves; <u>not suitable for potable water or chilled water systems</u> ; use with SR504-EXP-4 switching relay for on/off operation; BIO Barrier protects pump from system contaminants; SureStart automatic unblocking and air purging mode
 755867	0026e-F2	ECM HIGH EFFICIENCY CIRCULATOR—CAST IRON, variable 5-speed , 115/208/230V, 60/60 Hz, 1 phase, 1.05 amps, 120 watts, 830-3800 RPM; with ECM permanent magnet motor, dual electric knockouts and 6" stranded wire leads; 5 settings: activeADAPT, low, medium, high or 0-10V DC input, 44 gpm maximum flow; double insulated, use with SR switching relay for on/off operation; suitable for closed loop, pressurized heating and chilled water systems; BIO Barrier protects pump from system contaminants; SureStart automatic unblocking and air purging mode (Note: must be grounded per UL778 standard.)
 732956	VT2218-2F4	ECM TEMPERATURE SENSING, SELF-ADJUSTING, VARIABLE SPEED, HIGH EFFICIENCY WET ROTOR CIRCULATOR—CAST IRON , 110-120V, 50/60 Hz, 1 phase, 0.67 amps, 9-58 watts, 1650-4200 RPM; standard "S" one-way flange type; with ECM permanent magnet motor; 22' maximum shut-off head, 18 gpm maximum flow; operating modes include Delta-T differential temperature, 4 fixed speeds, set point heat, set point cool and boiler protection; designed for hydronic systems zoned with zone valves, radiant loops, injection pumping, snow-melt or hydro-air fan coils; can also be used in constant speed mode for zoning with circulators, indirect water heaters or primary boiler loops; BIO Barrier protects pump from system contaminants; SureStart automatic unblocking and air purging unblocking and air purging mode



FOR TACO ENGINEERING DATA, SEE PAGES 413.3-413.7

FOR FLANGES, SEE PAGES 414, 414.1 and 415.2

FOR ADDITIONAL INFORMATION, VISIT THE TACO WEBSITE AT: www.tacocomfort.com

TACO HYDRONIC SPECIALTIES



ID ORDER#	MODEL#	DESCRIPTION
694097	218-3	FLOW CHECK , 3/4", =B&G #107034 SA34
 732957	3450-T1	PRESSURE REDUCING/BACKFLOW PREVENTION COMBINATION VALVE , 1/2" NPT x 1/2" UNPT (=Taco #3450-T2)
658888	007-007RP	REPLACEMENT GASKET SET
 695606	SR504-4	SWITCHING RELAY WITH PRIORITY , 4-zone
694096	463-1	TANK FITTING WITH DRAIN AND SHUTOFF VALVE (=B&G #112010 AFT-12 and #113041 DT-2)
733151	UFS-075T	UNION—FNPT , for 006e3 circulators
 732960	ZVC404-EXP-1	ZONE VALVE WITH PRIORITY , 4-zone (=Taco #ZVC404-EXP, #ZVC404-EXP-4, and AVC404-EXP1), not compatible with White-Rodgers 3-wire zone valves

* = SPECIAL ORDER ITEM

FOR ADDITIONAL INFORMATION, VISIT THE TACO WEBSITE AT: www.tacosolutions.com
FOR DIFFERENTIAL BYPASS VALVE, SEE PAGE 412



007-F5-7IFC

Performance Field - 60Hz

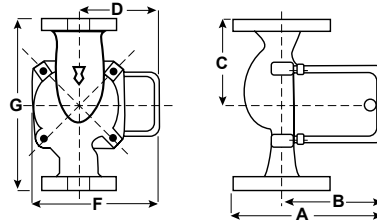
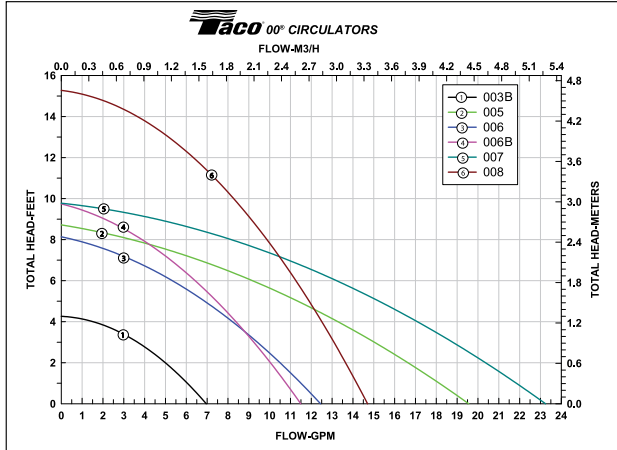

	DIMENSIONS (inches)					
	A	B	C	D	E	F
007-F5-71FC	6-1/8"	4-1/2"	3-3/16"	2-15/16"	5"	6-3/8"

Flow range: 0-17 gpm	Motors: 2-pole, single phase	Min. liquid temperature: 40°F
Head range: 0-8.5 feet	Max. liquid temperature: 230°F	Max. system pressure: 125 psi

0011-F4

Performance Field - 60Hz

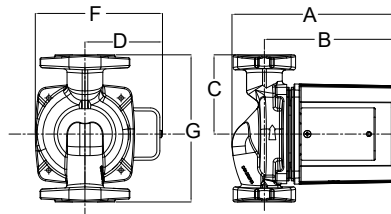
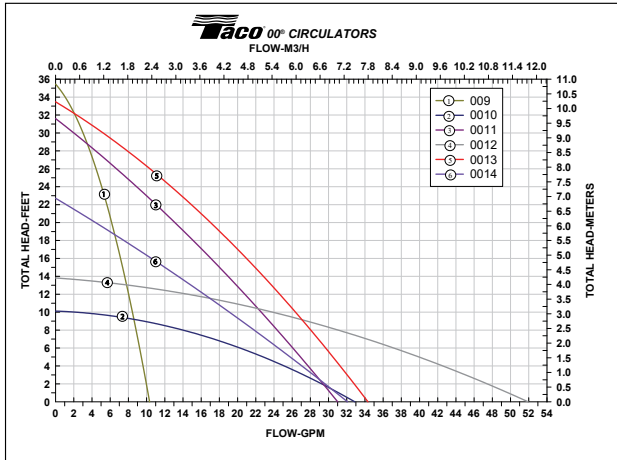

	DIMENSIONS (inches)					
	A	B	C	D	F	G
007-F5-71FC	7-1/2"	6-1/8"	3-1/2"	3-3/8"	5-5/8"	6-1/2"

Flow range: 0-31 gpm	Motors: 2-pole, single phase	Min. liquid temperature: 40°F
Head range: 0-31 feet	Max. liquid temperature: 230°F	Max. system pressure: 125 psi



0014-F1

Performance Field - 60Hz

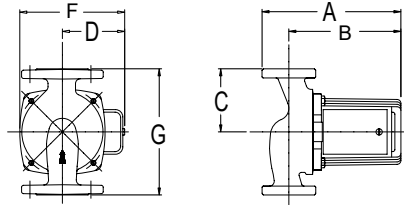
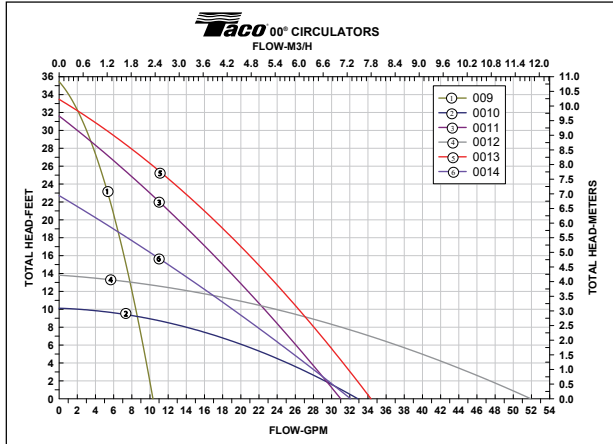

DIMENSIONS (inches)						
	A	B	C	D	F	G
0014-F1	7-1/4"	5-13/16"	3-1/4"	3-5/16"	5-3/8"	6-1/2"

Flow range: 0-32 gpm Motors: 2-pole, single phase Min. liquid temperature: 40°F
 Head range: 0-22 feet Max. liquid temperature: 230°F Max. system pressure: 125 psi

0013-MSF1-IFC

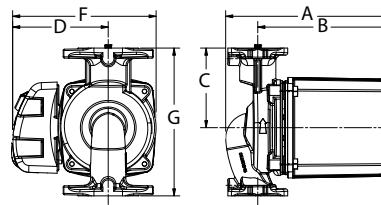
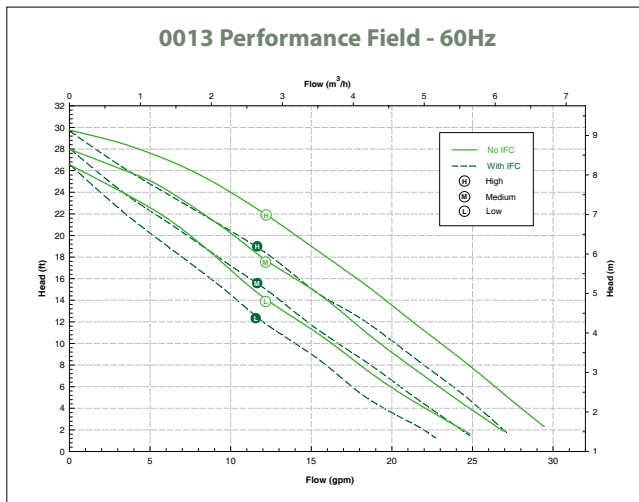

DIMENSIONS (inches)						
	A	B	C	D	F	G
0013-MSF1-IFC	7-1/4"	5-3/4"	3-1/2"	4-1/4"	6-1/4"	6-1/2"

Flow range: 0-30 gpm Motors: 2-pole, single phase Min. liquid temperature: 40°F
 Head range: 0-30 feet Max. liquid temperature: 210°F Max. system pressure: 125 psi



0015-MSF3-IFC

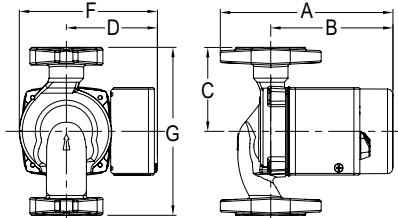
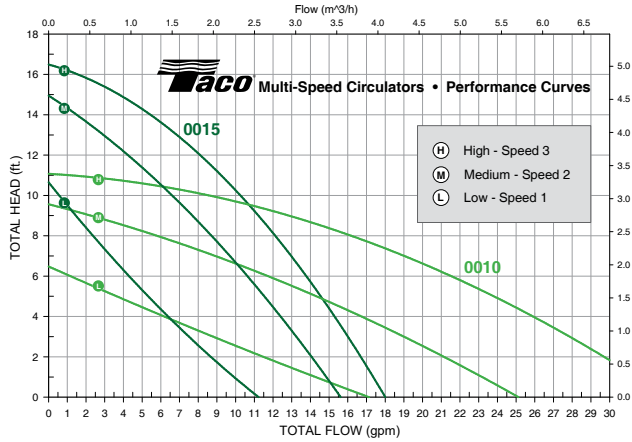

DIMENSIONS (inches)						
	A	B	C	D	F	G
0015-MSF3-IFC	6-1/2"	4-5/8"	3-3/16"	3-7/16"	5-3/8"	6-3/8"

Flow range: 0-18 gpm	Motors: 2-pole, single phase	Min. liquid temperature: 40°F
Head range: 0-17 feet	Max. liquid temperature: 230°F	Max. system pressure: 125 psi

006e3

Performance Curves

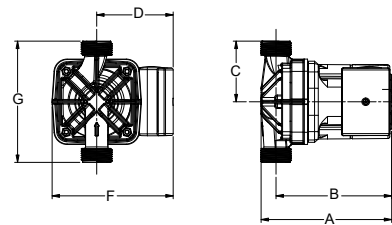
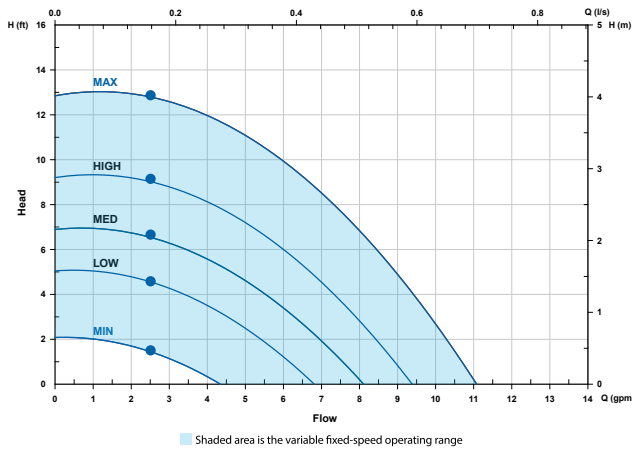

DIMENSIONS (inches)						
	A	B	C	D	F	G
006e3	5-1/2"	4-7/8"	2-5/8"	3-1/4"	5-1/8"	5-1/8"

Flow range: 0-11 gpm	Motors: 2-pole, single phase	Min. liquid temperature: 36°F
Head range: 0-13 feet	Max. liquid temperature: 203°F	Max. system pressure: 150 psi



007e-2F4

007e® Performance Curves

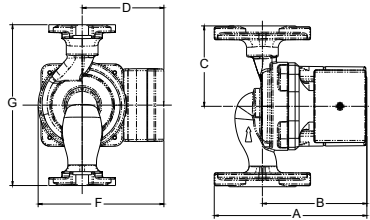
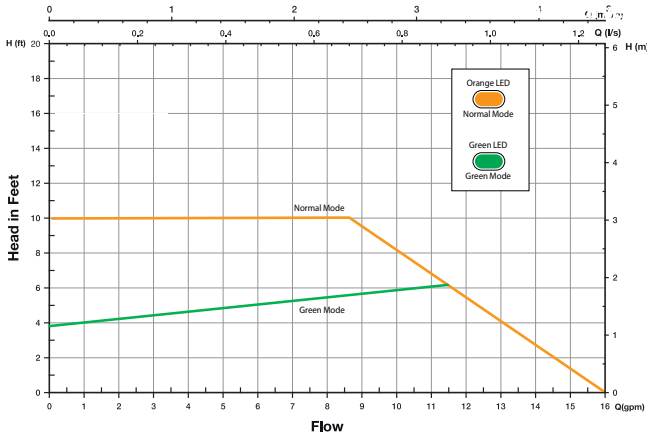

	DIMENSIONS (inches)					
	A	B	C	D	F	G
007e-2F4	6"	4-1/8"	3-3/16"	3-1/4"	5-1/8"	6-3/8"

Flow range: 0-16 gpm Motors: 2-pole, single phase Min. liquid temperature: 36°F
 Head range: 0-10 feet Max. liquid temperature: 230°F Max. system pressure: 125 psi

0015e3-2F4

Performance Curves

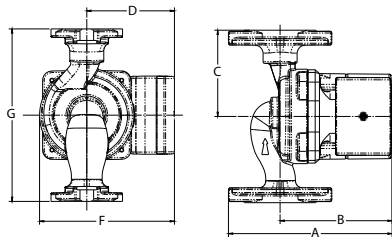
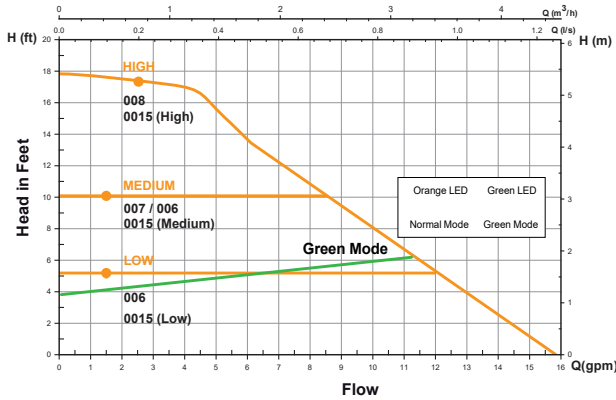

	DIMENSIONS (inches)					
	A	B	C	D	F	G
0015e3-2F4	6"	4-1/8"	3-3/16"	3-1/4"	5-1/8"	6-3/8"

Flow range: 0-16 gpm Motors: 2-pole, single phase Min. liquid temperature: 36°F
 Head range: 0-18 feet Max. liquid temperature: 230°F Max. system pressure: 125 psi



0026e-F2

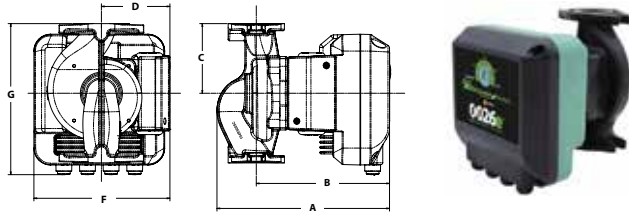
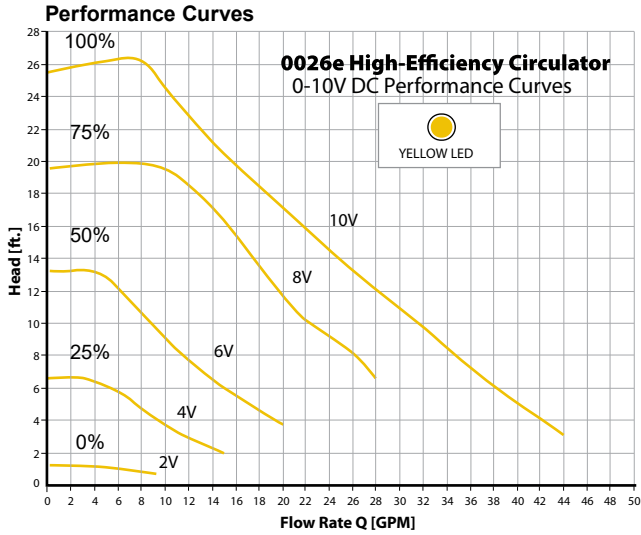

DIMENSIONS (inches)						
	A	B	C	D	F	G
0026e-F2	8.05"	6.22"	3.25"	3.20"	6.22"	7.05"

Flow range: 0-44 gpm
Head range: 0-26 feet

Motors: 2-pole, single phase
Max. liquid temperature: 230°F

Min. liquid temperature: 14°F
Max. system pressure: 150 psi

VT2218-2F4

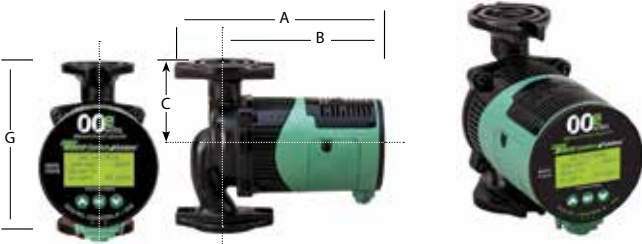
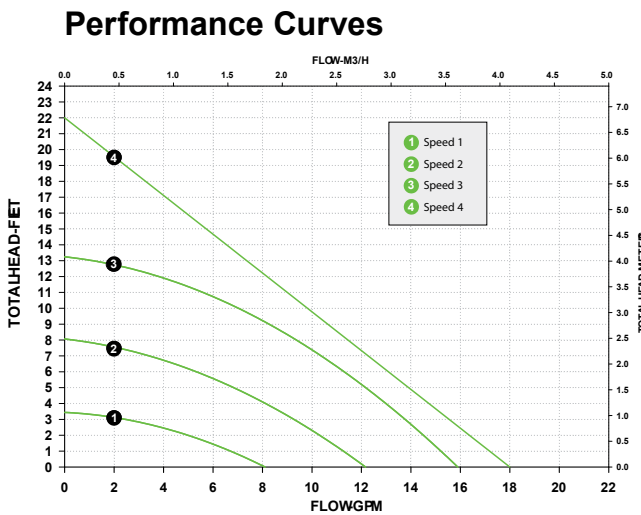

DIMENSIONS (inches)						
	A	B	C	D	F	G
VT2218-2F4	8-1/8"	6"	3-1/4"	2"	4-1/4"	6-3/8"

Flow range: 0-18 gpm
Head range: 0-22 feet

Motors: 2-pole, single phase
Max. liquid temperature: 230°F

Min. liquid temperature: 36°F
Max. system pressure: 125 psi

WEBSTONE PIPING KIT & THE ISOLATOR SERIES



ID ORDER#	MODEL#	SIZE	DESCRIPTION	* = SPECIAL ORDER ITEM
-----------	--------	------	-------------	------------------------

PIPING KIT FOR CONDENSING WATER HEATERS



669429 H-54443W 3/4" **LEAD FREE PIPING KIT**, FIP union x sweat (=Rinnai #WRIK-C and #SRIK-C); hot and cold set of full port forged brass ball valves with hi-flow hose drains; pressure relief valve outlet and adjustable packing glands; add for code-approved T&P valve, 500 CWP

748323 H-84443WPR 3/4" **PRESS TANKLESS WATER HEATER SERVICE VALVE KIT**

THE ISOLATOR UNI-FLANGE BALL VALVES



672765 H-13706HV 1-1/2" or 2" **THE ISOLATOR DOUBLE FLANGED CHECK VALVE**, flange x rotating flange, forged brass, includes one set of mounting bolts and full-faced flange gasket, 150 PSI at 200°F



446343 H-50403 3/4" **THE ISOLATOR UNI-FLANGE BALL VALVE WITHOUT DRAIN**, sweat x flange, full port forged brass, includes nuts and bolts, 600 WOG

446345 H-50404HV 1" *Same as above*, but fits both standard and high velocity pumps

585397 H-50405HV 1-1/4" *Same as above*

569474 H-50406HV 1-1/2" *Same as above*



586668 H-40404HV 1" **THE ISOLATOR UNI-FLANGE BALL VALVE WITHOUT DRAIN**, IPS x flange, full port forged brass, includes nuts and bolts, 600 WOG, fits both standard and high velocity pumps

586595 H-40405HV 1-1/4" *Same as above*

586669 H-40406HV 1-1/2" *Same as above*



594698 * H-40413 3/4" **THE ISOLATOR UNI-FLANGE BALL VALVE WITH HI-FLOW HOSE DRAIN**, IPS x flange, full port forged brass, includes wing style "T" handle and nuts and bolts, 600 WOG



446342 H-50413 3/4" **THE ISOLATOR UNI-FLANGE BALL VALVE WITH HI-FLOW HOSE DRAIN**, sweat x flange, full port forged brass, includes wing style "T" handle and nuts and bolts, 600 WOG

446344 H-50414HV 1" *Same as above*

585396 H-50415HV 1-1/4" *Same as above*

586667 H-50416HV 1-1/2" *Same as above*





69512 H-51403W 3/4" **THE ISOLATOR UNI-FLANGE BALL VALVE WITH ROTATING FLANGE**, sweat x rotating flange, full port forged brass, includes wing style "T" handle, adjustable packing gland, nuts and bolts, 600 WOG

ADDITIONAL INFORMATION, VISIT THE WEBSTONE WEBSITE AT www.webstonevalves.com

WEBSTONE THE ISOLATOR



ID ORDER#	MODEL#	SIZE	DESCRIPTION	* = SPECIAL ORDER ITEM
	693985	H-81403HV	3/4"	THE ISOLATOR UNI-FLANGE BALL VALVE WITH ROTATING FLANGE , press x rotating flange, full port forged brass, includes adjustable gland, nuts and bolts, 250 psi, 250°F max
	740220	H-81404HV	1"	Same as above
	740221	H-81405HV	1-1/4"	Same as above
	740222	H-81406HV	1-1/2"	Same as above
	740223 *	H-81407HV	2"	Same as above
	693986	H-81413HV	3/4"	THE ISOLATOR UNI-FLANGE BALL VALVE WITH ROTATING FLANGE AND MULTI-FUNCTION HI-FLOW HOSE DRAIN , press x rotating flange, full port forged brass, includes adjustable packing glands, nuts and bolts, 250 psi, 250°F max
	695642	H-81414HV	1"	Same as above
	693992	H-81415HV	1-1/4"	Same as above
	699178	H-81416HV	1-1/2"	Same as above

ADDITIONAL INFORMATION, VISIT THE WEBSTONE WEBSITE AT www.webstonevalves.com



ID ORDER#	MODEL#	SIZE	DESCRIPTION	* = SPECIAL ORDER ITEM
-----------	--------	------	-------------	------------------------

PRO-PAL EXPANSION TANK PRO SERVICE VALVES



642162	H-41672	--	PRO-PAL SERIES BALL VALVE WITH HI-FLOW HOSE DRAIN, lead free, C x C, full port forged brass, includes adjustable packing gland and reversible handle, 600 psi
--------	---------	----	--

PRO-PAL SERIES BALL VALVES



669423	H-50613W	3/4"	PRO-PAL SERIES BALL VALVE WITH HI-FLOW HOSE DRAIN, lead free, C x C, full port forged brass, includes adjustable packing gland and reversible handle, 600 psi, 250°F max
669424	H-50614W	1"	Same as above
696482	H-50615W	1-1/4"	Same as above

PRO-PAL SERIES BALL VALVE DRAINS



669426 *	H-50673W	3/4"	PRO-PAL SERIES T-DRAIN FITTING WITH HI-FLOW HOSE DRAIN, lead free, C x C, full port brass fitting, 600 psi, 250°F max
669427 *	H-50674W	1"	Same as above
669428 *	H-50675W	1-1/4"	Same as above
743260	H-80613	3/4"	PRO-PAL SERIES BALL VALVE DRAIN WITH HI-FLOW HOSE DRAIN, press, full port forged brass, includes reversible handle and adjustable packing glands, 250 psi, 250°F max
743261	H-80614	1"	Same as above
743262	H-80615	1-1/4"	Same as above

PRO-PAL SERIES PURGE TEES



619750	H-58644	1" x 1"	PRO-PAL SERIES PRIMARY/SECONDARY LOOP PURGE TEE, C x C, full port forged brass, includes reversible handle, 600 psi, 250°F max
586671	H-58654	1-1/4" x 1"	Same as above
585399	H-58655	1-1/4" x 1-1/4"	Same as above
738061	H-88644	1" x 1"	PRO-PAL SERIES PRIMARY/SECONDARY LOOP PURGE TEE, press, full port forged brass, includes reversible handle, 250 psi, 250°F max
743258	H-88654	1-1/4" x 1"	Same as above
743259	H-88655	1-1/4" x 1-1/4"	Same as above

PRO-CONNECT WATER HEATER CONNECTORS



721944	H-26033W-18	3/4" x 3/4"	PRO-CONNECT WATER HEATER CONNECTOR, 18", push x FIP, flexible braided stainless steel, 200 psi, 200°F max, lead-free
721945	H-62033W-18	3/4" x 3/4"	Same as above, but with full port forged DZR brass ball valve

PRO-CONNECT PRESSED AIR SEPARATOR



743219	H-78004	1"	PRO-CONNECT PRESSED AIR SEPARATOR, with removable vent and and coalescing medium, 150 psi
743220	H-78005	1-1/4"	Same as above



ID ORDER#	MODEL#	PRODUCT CODE	MAX HP	SPEED	DESCRIPTION
CLOSED SYSTEM CIRCULATORS — 3 SPEED					
234361	UPS15-58FC	59896341	1/25 HP	3 speed	CIRCULATOR—CAST IRON BODY , GF15/26 2-bolt flanged housing, 115V, UL listed
742680	UPS15-58FRC	59896343	1/25 HP	3 speed	Same as above, but with GF15/26 <u>rotated</u> 2-bolt flanged housing
568685	UPS26-99FC	52722512	1/6 HP	3 speed	CIRCULATOR—CAST IRON BODY , GF15/26 2-bolt flanged housing, 115V, UL listed
638106	UPS26-150F	95906630	1/3 HP	3 speed	CIRCULATOR—CAST IRON BODY , GF15/26 2-bolt flanged housing, 115V, UL listed
635130	UPS43-100F	95906636	1/3 HP	3 speed	CIRCULATOR—CAST IRON BODY , GF40/43 2-bolt flanged housing, 115V, UL listed
691425	UPS50-44F	52722557	1/6 HP	3 speed	CIRCULATOR—CAST IRON BODY , GF50 2-bolt flanged housing, 115V, UL listed
721392	UPS50-60F	97523134	1/2 HP	3 speed	CIRCULATOR—CAST IRON BODY , GF50 <u>4-bolt</u> flanged housing, 115V, UL listed; Add for required #96409354 2" cast iron flange set

FOR GRUNDFOS ENGINEERING DATA, SEE PAGES 416.3-416.7

FOR GRUNDFOS ACCESSORIES, SEE PAGE 416.2

FOR ADDITIONAL INFORMATION, VISIT THE GRUNDFOS WEBSITE AT us.grundfos.com

Limited Warranty: The UPS Series circulators are warranted for 3 years from date of manufacture. All others are warranted for 2 years from date of installation, not to exceed 30 months from date of manufacture.



ID ORDER#	MODEL#	PRODUCT CODE	MAX HP	SPEED	DESCRIPTION	* = SPECIAL ORDER ITEM
OPEN SYSTEM CIRCULATORS						
207358	UP15-10SU7P/TLC	595916	1/25 HP	--	COMFORT SYSTEM RETROFIT CIRCULATOR –STAINLESS STEEL BODY , 115V, non-digital timer, 10' 3-prong power cord, integral check valve, hot water tank fittings including (1) valve and (2) 1/2" FNPS x 1/2" FNPS x 12" stainless steel flex hoses	
588639	UP15-29SU	59896775	1/12 HP	1 speed	CIRCULATOR–STAINLESS STEEL BODY , GU125 union housing, 115V, UL listed	
588588	UPS15-35SFC	59896772	1/15 HP	3 speed	CIRCULATOR–STAINLESS STEEL BODY , GF15/26 union housing, integral check valve, 115V, UL listed	

COMFORT VALVE

227024 *	--	595926	--	--	COMFORT VALVE , single, for use with UP-15-10SU7P/TLC Comfort System Retrofit circulator	
----------	----	--------	----	----	---	--

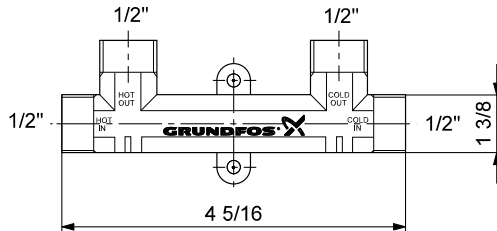

FOR ENGINEERING DATA, SEE PAGES 416.3-416.7

FOR GRUNDFOS ACCESSORIES, SEE PAGE 416.2

FOR ADDITIONAL INFORMATION, VISIT THE GRUNDFOS WEBSITE AT us.grundfos.com

Limited Warranty: The UPS Series circulators are warranted for 3 years from date of manufacture. All others are warranted for 2 years from date of installation, not to exceed 30 months from date of manufacture.

GRUNDFOS CIRCULATOR ACCESSORIES



ID ORDER#	MODEL#	PRODUCT CODE	MAX HP	DESCRIPTION
--------------	--------	-----------------	-----------	-------------

PACKAGED FITTING FLANGE/UNION SETS

1337	GF 15/26	51960	3/4" NPT	FLANGE SET—CAST IRON
1338	GF 15/26	519602	1"	<i>Same as above</i>
1339	GF 15/26	519603	1-1/4"	<i>Same as above</i>
1340	GF 15/26	519604	1-1/2"	<i>Same as above</i>
1347	GF 40/43	539605	1-1/2"	FLANGE SET—CAST IRON
213896	GF 50	96409354	2"	FLANGE SET—CAST IRON
1341	GF 15/26	519651	3/4"	FLANGE SET—BRONZE
1342	GF 15/26	519652	1"	<i>Same as above</i>
1346	GU 125	529912	3/4"	UNION SET—BRONZE

CAST IRON PACKAGED FITTING SETS

MATERIAL NUMBER	BODY TYPE	PUMP CONNECTION	NPT
519601	Cast Iron	GF 15/26 flange	3/4"
519602	Cast Iron	GF 15/26 flange	1"
519603	Cast Iron	GF 15/26 flange	1-1/4"
519604	Cast Iron	GF 15/26 flange	1-1/2"
539605	Cast Iron	GF 40/43 flange	1-1/2"
96409354	Cast Iron	GF 50 flange	2"

BRONZE PACKAGED FITTING SETS

MATERIAL NUMBER	BODY TYPE	PUMP CONNECTION	NPT
519651	Bronze	GF 15/26 flange	3/4"
519652	Bronze	GF 15/26 flange	1"
529912	Bronze	GU 125 union	3/4"

REPLACEMENT FLANGES & GASKETS

43800	--	99880243 (530244)	1-1/2"	FLANGE GASKET, 2-bolt, 2/pkg
761221	--	99882655 - (91130069)	-	OVAL FLANGE, for bronze isolation valve sets, 2/pkg

FOR ENGINEERING DATA, SEE PAGES 416.3-416.7

FOR ADDITIONAL INFORMATION, VISIT THE GRUNDFOS WEBSITE AT us.grundfos.com

GRUNDFOS CIRCULATOR ENGINEERING DATA



UPS15-58FC/FCR

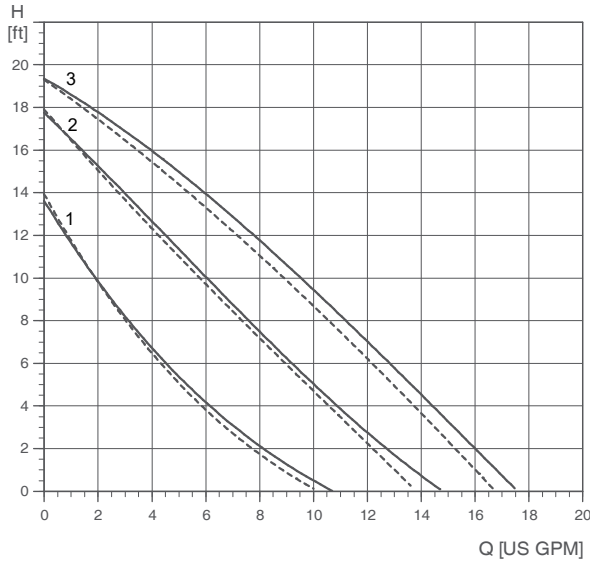

UPS15-58FC

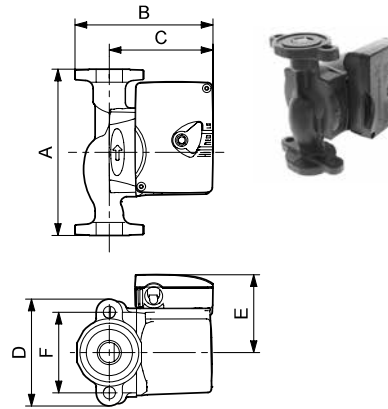

UPS15-58FC

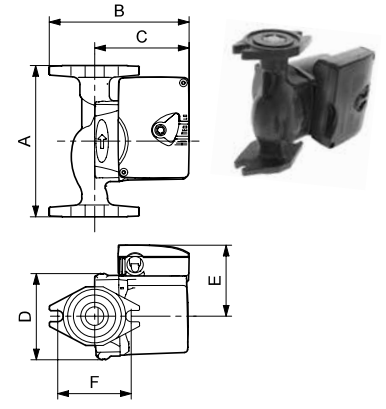

	DIMENSIONS (inches)					
	A	B	C	D	E	F
UPS15-58FC	6-1/2	5-1/4	4	4-3/16	3	3-5/32
UPS15-58FCR	6-1/2	5-1/14	4	4-3/16	3	3-5/32

Flow range: 0-17 gpm	Motors: 2-pole, single phase	Min. liquid temperature: 36°F
Head range: 0-19.5 feet	Max. liquid temperature: 230°F	Max. system pressure: 145 psi

UPS26-99FC

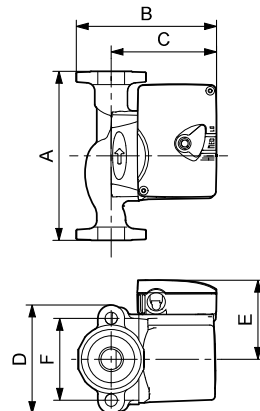
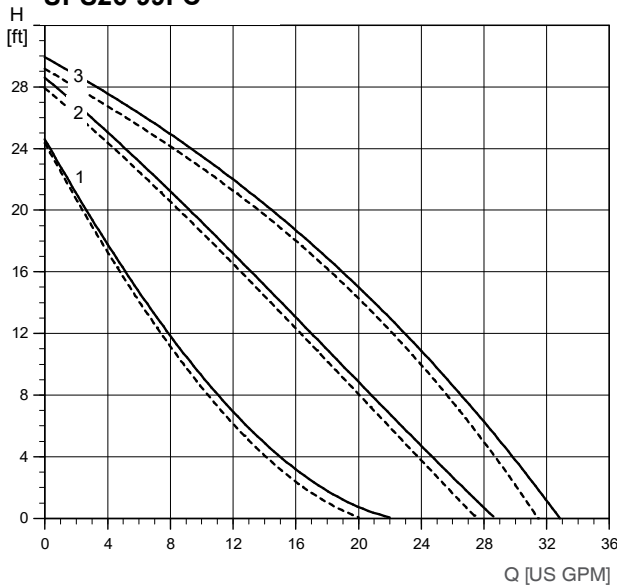

	DIMENSIONS (inches)					
	A	B	C	D	E	F
UPS26-99FC	6-1/2	6	4-7/8	3-1/2	3-7/16	3-5/32

Flow range: 0-33 gpm	Motors: 2-pole, single phase	Min. liquid temperature: 36°F
Head range: 0-29 feet	Max. liquid temperature: 230°F	Max. system pressure: 145 psi

GRUNDFOS CIRCULATOR ENGINEERING DATA



UPS26-150F

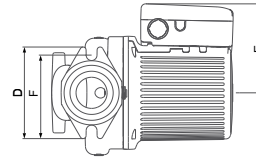
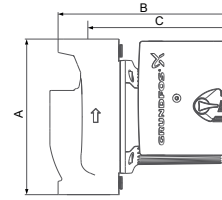
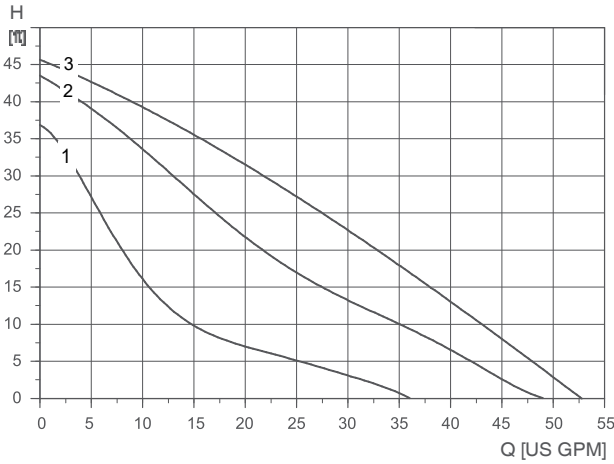

	DIMENSIONS (inches)					
	A	B	C	D	E	F
UPS26-150F	6-1/2	7-1/8	5-7/8	3-7/8	3-3/4	3-1/8

Flow range: 0-53 gpm Motors: 2-pole, single phase Min. liquid temperature: 36°F
 Head range: 0-46 feet Max. liquid temperature: 230°F Max. system pressure: 145 psi

UPS43-100F

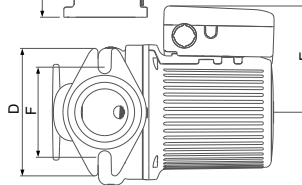
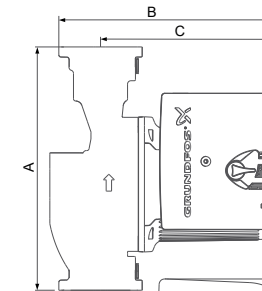
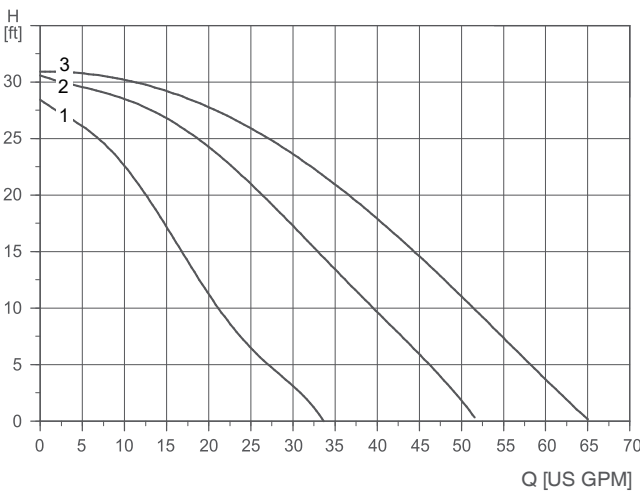

	DIMENSIONS (inches)					
	A	B	C	D	E	F
UPS43-100F	8-1/2	7-3/8	5-7/8	4-1/2	3-3/4	3-1/8

Flow range: 0-65 gpm Motors: 2-pole, single phase Min. liquid temperature: 36°F
 Head range: 0-31 feet Max. liquid temperature: 230°F Max. system pressure: 145 psi

GRUNDFOS CIRCULATOR ENGINEERING DATA



UPS50-44F

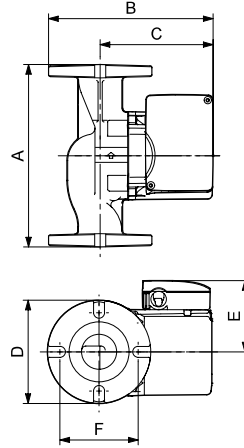
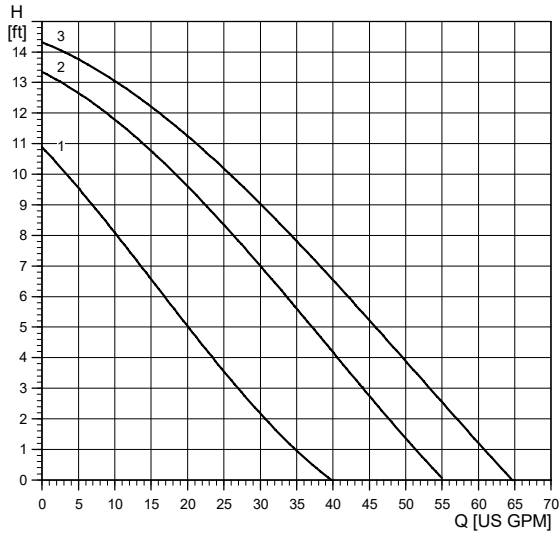

DIMENSIONS (inches)						
	A	B	C	D	E	F
UPS50-44F	8-1/2	7-1/2	5-1/16	4-7/8	3-1/2	4-1/6

Flow range: 0-65 gpm Motors: 2-pole, single phase Min. liquid temperature: 32°F
 Head range: 0-14.4 feet Max. liquid temperature: 230°F Max. system pressure: 145 psi

UPS50-60F

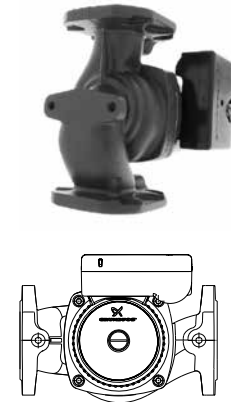
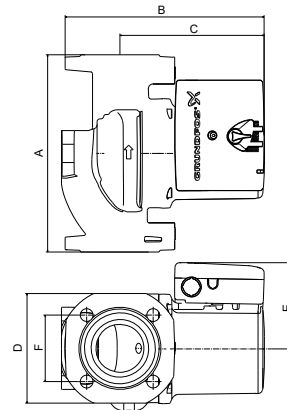
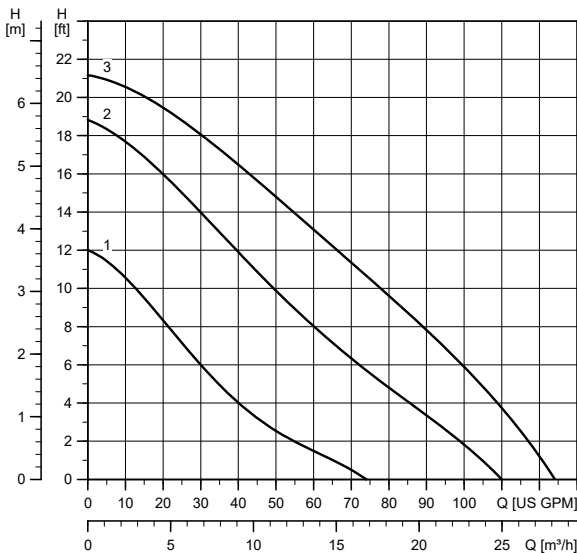

DIMENSIONS (inches)						
	A	B	C	D	E	F
UPS50-44F	8-1/2	8-5/8	6-1/4	4-3/4	3-3/4	2-7/8

Flow range: 0-120 gpm Motors: 2-pole, single phase Min. liquid temperature: 36°F
 Head range: 0-21 feet Max. liquid temperature: 230°F Max. system pressure: 145 psi

GRUNDFOS CIRCULATOR ENGINEERING DATA



UP15-10SU7P/DTLC

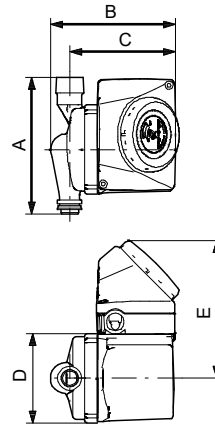
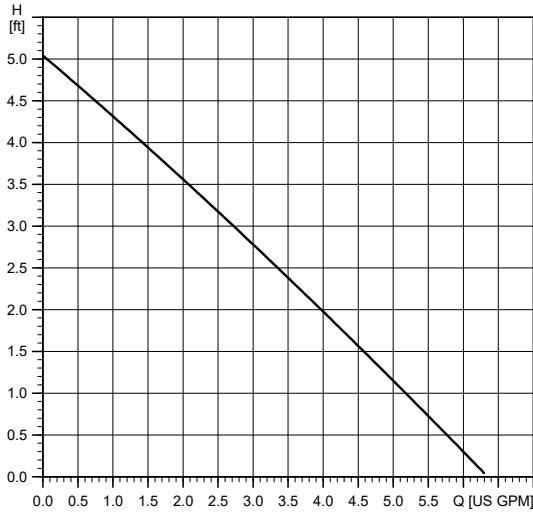

DIMENSIONS (inches)						
	A	B	C	D	E	F
UP15-10SU7P/DTLC	5-7/16	6-1/4	5-1/2	3-7/16	3-1/4	4

Flow range: 0-6.3 gpm	Motors: 2-pole, single phase	Min. liquid temperature: 36°F
Head range: 0-5.1 feet	Max. liquid temperature: 150°F	Max. system pressure: 145 psi

UP15-29SU

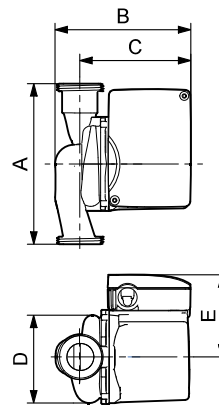
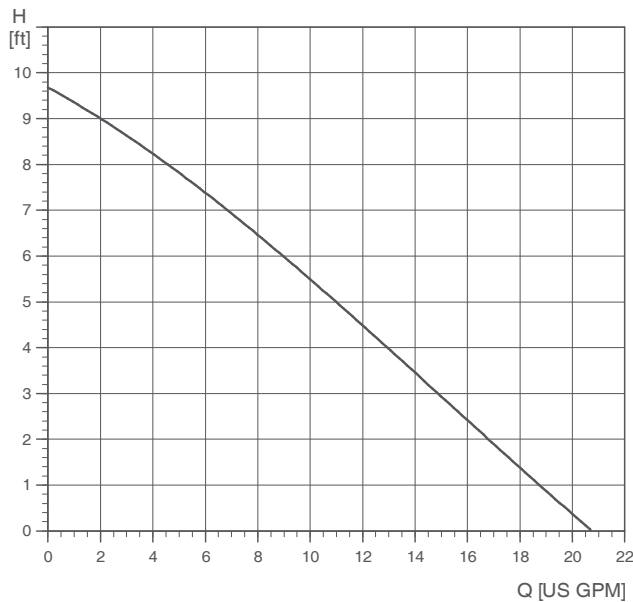

DIMENSIONS (inches)						
	A	B	C	D	E	F
UP15-29SU	5-7/8	5-1/2	4-1/8	3-7/16	2-15/16	--

Flow range: 0-20.5 gpm	Motors: 2-pole, single phase	Min. liquid temperature: 36°F
Head range: 0-9.7 feet	Max. liquid temperature: 230°F*	Max. system pressure: 145 psi
*Note: if the UP15-29SU circulator is equipped with a timer, the maximum liquid temperature is 150°F.		

GRUNDFOS CIRCULATOR ENGINEERING DATA



UPS15-35SFC

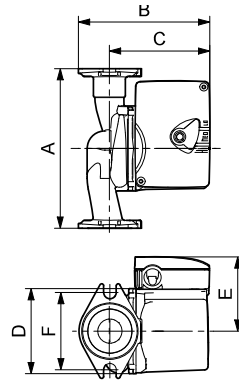
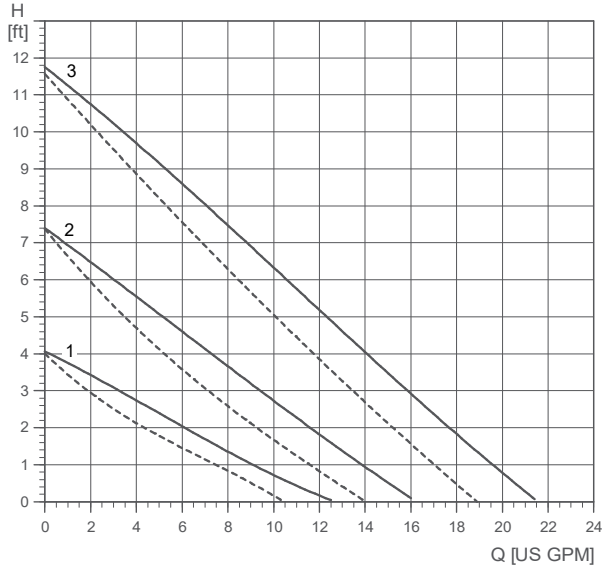

	DIMENSIONS (inches)					
	A	B	C	D	E	F
UPS15-35SFC	6-1/2	5-1/2	4-1/8	3-7/8	2-15/16	3-1/8

Flow range: 0-21.5 gpm	Motors: 2-pole, single phase	Min. liquid temperature: 36°F
Head range: 0-12 feet	Max. liquid temperature: 165°F	Max. system pressure: 145 psi

AMTROL CLASSIC BOILERMATE SERIES



- High density polyethylene bottle
- Corrosion-proof, high-temperature polymer rated to 180°F
- Molded insulation form fitted to bottle
- Deep drawn dome with steel base and high gloss blue finish
- Removable heat exchanger with finned design
- Mechanical aquastat
- Includes T & P valve and brass drain
- 150 psi maximum working pressure; 150°F maximum operating temperature

NOTE: ADD FOR CIRCULATING PUMP OR ZONE VALVE

WARRANTY

- 6-year limited warranty on heat exchanger and tank; 1-year limited warranty on parts

Warranty Disclaimer: The factory warranty is invalid if a pressurized diaphragm-type thermal expansion tank such as the Amtrol Therm-x-trol is not used when installing a backflow preventer, pressure-reducing valve or check valve in the cold water supply.



**CH-41Z-B
Top Connect**

WARNING!
Damage to the unit and leakage can occur if a vacuum breaker is not installed! Use Wilkins #12-VR10XL (ID #217972).

ID ORDER#	MODEL#	AMTROL PART NO.	CAPACITY (gallons)	HEIGHT (inches)	DIAMETER (inches)	COLD WATER INLET (M.I.P.)	HOT WATER OUTLET (F.I.P.)	BOILER SUPPLY (M.I.P.)	BOILER RETURN (M.I.P.)
626066	CH-41Z-B	2703Z01-6	41	48	22	3/4"	3/4"	3/4"	3/4"

Performance		
CH-41		
BOILER OUTPUT	FIRST-HOUR RATING (90°F rise)	CONTINUOUS FLOW (70°F rise)
BTU/HR	GAL	GPH
40,000	89	69
60,000	116	104
80,000	143	139
100,000	170	173

FOR BOILERMATE REPLACEMENT PARTS, SEE PAGE 418.1

FOR ADDITIONAL INFORMATION, VISIT THE AMTROL WEBSITE AT www.amtrol.com

SEPTEMBER 2024

Line #4400

AMTROL

BOILERMATE REPLACEMENT PARTS

417.1









ID ORDER#	AMTROL PART NO.	DESCRIPTION	FOR MODEL	* = SPECIAL ORDER ITEM
39043	393232 (2704-093)	AQUASTAT/THERMOSTAT	WH-7Z, CH-41Z, WH-60Z, WH-80Z, WHS-80Z, WH-120Z	
30588	392923 (2500-218)	FLANGE GASKET , 8 bolt (NOTE: This is not a warranty part. The homeowner should contact the factory directly.)	WH-7 and WH-9 Series	
151557 *	393037 (2700-5000)	HEAT EXCHANGER REPLACEMENT KIT , 8-bolt flange	For all but WH-7C	
655630	396411 (940R101)	SMARTCONTROL , digital for WH, WHS and TD replacement and upgrade	All SmartControl models	

**FOR ADDITIONAL INFORMATION, VISIT THE
AMTROL WEBSITE AT www.amtrol.com**

AMTROL HYDRONIC SPECIALTIES

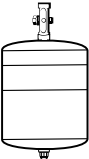
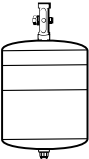

* = SPECIAL ORDER ITEM

	ID ORDER#	MODEL#	DIMENSIONS	DESCRIPTION
	2379	443	1"	AIR PURGER (=Legend #110-345)
	2380	444	1-1/4"	Same as above (=Legend #110-346)
	2381	445	1-1/2"	Same as above
	2382	446	2"	Same as above
	50905	447	2-1/2"	Same as above
	5873	608	1/2"	COPPER TUBE STRAP , uncoated, for nailing directly to joist, 100/box
	5874	608	3/4"	Same as above, but 50/box
	5875	608	1"	Same as above
	5876	608	1-1/4"	Same as above
	2365	EX-15	8" x 13"	EXTROL INLINE EXPANSION TANK , 2.0 gallon
	2366	EX-30	11" x 15"	Same as above, but 4.4 gallon
	2367	EX-60	11" x 23"	Same as above, but 7.4 gallon
	2368	SX-40V	15" x 32"	Same as above, but 20.0 gallon and for vertical applications
	94733	SX-60V	15-3/8" x 47-1/2"	Same as above, but 32.0 gallon and for vertical applications
	776246 *	EX-15PRO	8" x 13"	EXTROL PRO INLINE EXPANSION TANK , 2.0 gallon
765301	EX-30PRO	11" x 15"	Same as above, but 4.4 gallon	
776210	EX-60PRO	11" x 20"	Same as above, but 6.7 gallon	
	765301	EX30-PRO	11" x 15"	RADIANT EXTROL PRO INLINE HEATING SYSTEM EXPANSION TANK , 4.4 gallon
	2369	109-133	8" x 13"	FILL-TROL TANK ONLY , less valve, 2.0 gallon
	2370	110-002	11" x 15"	Same as above, but 4.4 gallon
	2371	110-1	11" x 17"	FILL-TROL TANK , with straight valve, but 4.4 gallon
	2372	109-15	--	FILL VALVE ONLY , straight
	2374 *	420	1/2"	MIXING VALVE , 6 gpm, 110°F to 170°F range, adjustable and repairable
	2375	421	3/4"	Same as above, but 12 gpm rating
	2377	420-6	--	MIXING VALVE REPLACEMENT CARTRIDGE , for #420 and #421 mixing valves
	39682	ST-5	8" x 13"	THERM-X-TROL INLINE EXPANSION TANK , 2.0 gallon, for use with potable water heaters only, pre-pressurized, diaphragm-type, ANSI/NSF 61 approved
	153214	ST-12	11" x 15"	Same as above, but 4.4 gallon
	150953	ST-25V	15" x 19"	Same as above, but 10.3 gallon and for vertical applications

FOR ADDITIONAL INFORMATION, VISIT THE AMTROL WEBSITE AT www.amtrol.com

AMTROL WELL-X-TROL TANKS









ID ORDER#	MODEL#	DIMENSIONS	DESCRIPTION
616237	WX-103	22" x 11"	WELL-X-TROL IN-LINE WELL TANK , 6.7 gallon, volume, blue color, stainless steel elbow, 38 PSIG precharge pressure, 1" NPTF, 150 PSIG maximum working pressure, 7-year residential warranty
452803	WX-202	32" x 15"	WELL-X-TROL VERTICAL STAND WELL TANK , 20 gallon volume, blue color, stainless steel elbow, 38 PSIG precharge pressure, 1" NPTF, 150 PSIG maximum working pressure, 7-year residential warranty
616234	WX-203	47" x 15"	<i>Same as above</i> , but 32 gallon
617826	WX-250	36" x 22"	<i>Same as above</i> , but 44 gallon

**FOR ADDITIONAL INFORMATION, VISIT THE
AMTROL WEBSITE AT www.amtrol.com**

BOSHART PUMP & WELL ACCESSORIES



	ID ORDER#	MODEL#	DIMENSIONS	DESCRIPTION
	721785	BMA-100NL	1" MPT x 1" INS	ADAPTER—MALE , no lead bronze
	721786	BMA-125NL	1-1/4" MPT x 1-1/4" INS	<i>Same as above</i>
	721784	PG-100NL	2"	DIAL PRESSURE GAUGE , no lead, 1/4" LM 0-100
	721799	2-SSC8712	1-1/4"	HOSE CLAMP—ADJUSTABLE , 5/16" 305 stainless steel, slotted hex head screw, 300 series stainless steel band and housing, 1/2" wide band, box of 10
	721800	2-SSC8716	1-1/2"	<i>Same as above</i>
	721787	PS02-2040	1/4" FPT	PRESSURE SWITCH , 20-40 psi
	721791	PS02-3050	1/4" FPT	Same as above, but 30-50 psi
	721792	PS02-4060	1/4" FPT	Same as above, but 40-60 psi
	721798	SSRVN05-100	1/2" MPT x 1/2" FPT	RELIEF VALVE—304 STAINLESS STEEL , 1/2" MPT inside, 1/2" FPT outside, 100 psi
	721795	2-07TK-25-2NL	1" male x 10"	TANK TEE—NON-UNION , heavy duty 304 stainless steel head casting with permanently-installed 304 stainless steel Schedule 40 pipe nipple leg, permanent hard setting thread sealant, provides high corrosion resistance
	721794	2-07TK-25S-2NL	1" male x 3-5/8"	<i>Same as above</i>
	721797	2-07TKO-25-2UNL	1" male x 10"	TANK TEE—UNION , heavy duty 304 stainless steel head casting with permanently-installed 304 stainless steel Schedule 40 pipe nipple leg, American Standard BUNA N O-ring, provides high corrosion resistance
	721796	2-07TKO-25S-2UNL	1" male x 4-1/2"	<i>Same as above</i>

FOR ADDITIONAL INFORMATION, VISIT THE BOSHART WEBSITE AT www.boshart.com



ID ORDER#	DIAL SIZE	MODEL#	DESCRIPTION
--------------	--------------	--------	-------------

PRESSURE GAUGES

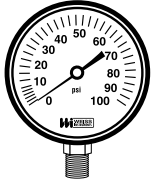

140782	2-1/2"	TL25-015-4L	PRESSURE GAUGE , 1/4" NPT <u>bottom</u> (lower) connect, 0-15 psi
140783	2-1/2"	TL25-060-4L	Same as above, but 0-60 psi
140784	2-1/2"	TL25-100-4L	Same as above, but 0-100 psi
140785	2-1/2"	TL25-200-4L	Same as above, but 0-200 psi
140786	2-1/2"	TL25-300-4L	Same as above, but 0-300 psi
140799	3-1/2"	TL35-200-4L	PRESSURE GAUGE , 1/4" NPT <u>bottom</u> (lower) connect, 0-200 psi
742440	4"	TL40-030-4L	PRESSURE GAUGE , 1/4" NPT <u>bottom</u> (lower) connect, 0-30 psi
742431	4"	TL40-100-4L	Same as above, but 0-100 psi
742439	4"	TL40-200-4L	Same as above, but 0-200 psi
140790	2-1/2"	TL25-V150-4L	COMPOUND PRESSURE GAUGE , 1/4" NPT <u>bottom</u> (lower) connect, 0-150 psi

THERMOMETERS

140805	--	TL5S2-240	THERMOMETER , straight type, 30° to 240°F range, furnished with 5" scales and 2" stems, including a 1/2" NPT brass socket
140806	--	TL5A2-240	Same as above, but angle type

TEST PLUGS

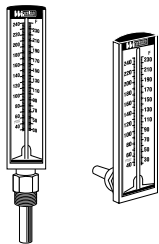

59246	--	BP50-NR	TEST PLUG , 1/2" NPT, brass body and cap, rated at 1000 psi, 275°F maximum temperature, self-sealing Nordel® core, for hot and chilled water
-------	----	---------	---

FOR ADDITIONAL INFORMATION, VISIT THE WEISS WEBSITE AT www.weissinstruments.com

WESTWOOD THERALTIMETERS (TRIDICATORS) LINE #5890

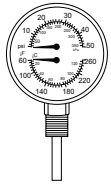

ID ORDER#	MODEL#	PSI	DIAL SIZE	DESCRIPTION
4235	H25-16	75	2-1/2"	ROUND , center back tap with 3/4" shank, 1-1/2" element, 1/4" MPT, 60°F to 320°F range
4236	H25-15	75	2-1/2"	ROUND , center back tap with 2" shank, 1-1/2" element, 1/4" MPT, 60°F to 320°F range
4238	H25-18	50	3-1/2"	ROUND , bottom tap with 1" shank, 2" element, 1/2 MPT, 60°F to 260°F range
4234	H25-17	50	3-1/2"	ROUND , lower edge back tap with 1-1/2" shank, 2" element, 1/2" MPT, 60°F to 260°F range

SPARCO DIAL THERMOMETERS LINE #4480/4440

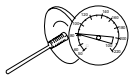

160705	GT161	--	2"	DIAL THERMOMETER , 1/2" NPT, 2" insertion, 32°F to 250°F, steel case with brass well
--------	-------	----	----	---



FOR OTHER SPARCO PRODUCTS, SEE PAGES 427-427.1

For ACCUSTAT BY PSG, Line # 7500, compact dial thermometers and test plugs, please refer to the 600 section.

ID ORDER#	MODEL#	DESCRIPTION
771555	110-301	STEAM AIR VENT(LEGEND)—#T-60 , 1/8" angle
771554	110-305	ADJUSTABLE STEAM AIR VENT(LEGEND)—#T-60A , 1/8" angle (replaces Hoffman 1A)
58387	110-338	COIN AIR VENT (LEGEND)—#T-77 , 1/8"
49829	5SN	COIN AIR VALVE (KEENEY) , vent assembly with 3/16" x 21" tubing, 1/8" NPT connection
1484	600	FLEXIBLE C x C CONNECTOR (HYDRO-FLEX) , 3/4" x 18"

HOFFMAN STEAM SPECIALTIES

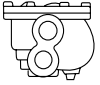
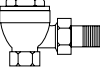

	ID ORDER#	MODEL#	SIZE	DESCRIPTION	* = SPECIAL ORDER ITEM
	53240	FT015H-3	3/4"	FLOAT & THERMOSTATIC TRAP , 15 PSI (= Trane #55AL)	
	53241	FT015H-4	1"	Same as above, but 1"	
	31602 *	17C	1/2"	THERMOSTATIC TRAP , <u>vertical</u> , 25 PSI	
	1873	17C	1/2"	Same as above, but <u>angle</u> type, 25 PSI	
	1890	74	1/2"F x 3/4"M	UNIT HEATER STEAM VENT , 15 PSI	
	1892	75	1/2"F x 3/4"M	MAIN STEAM LINE VENT , straight, 15 PSI	
	1893	79	1/2"F x 3/4"M	MAIN HOT WATER VENT , straight, 75 PSI	
	1894 *	790	1/8"	Same as above, except 30 PSI	
	1875 *	A1198-8C	--	SERVICE PACK FOR 8C , includes: #A115SP8 lockwasher, #B566 thermostat, #A1173X seat	
	9191	1A	--	VARI-VENT , adjustable, 2 psi maximum with 1/8" angle connection (=Dole #1A)	

FOR ADDITIONAL INFORMATION, VISIT THE
HOFFMAN WEBSITE AT www.bellgossett.com/hoffman-specialty-products

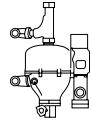

ID ORDER#	MODEL#	DESCRIPTION	* = SPECIAL ORDER ITEM
-----------	--------	-------------	------------------------

4430 47-2 **BOILER FEEDER AND LOW WATER CUTOFF** for 25 PSI maximum operating steam pressure

64985 * 61 **LOW WATER CUTOFF**, float-type, rated at 20 PSI steam (=Weil-McLain #511-114-474)

235231 63M **LOW WATER CUTOFF**, with manual reset, float-type, rated at 50 PSI steam (=Weil-McLain #511-114-479)

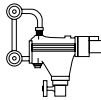

4432 67 **EXTERNAL LOW WATER CUTOFF**, for steam boiler with quick hook-up fittings, 1/2" tapping

66135 150S-MD **PUMP CONTROLLER AND LOW WATER CUTOFF**, rated at maximum 50 PSI steam (=Weil-McLain #511-114-526)

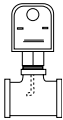

4498 6667 **HEAD MECHANISM**, for 67 series

ID ORDER#	PART #	DESCRIPTION	ID ORDER#	PART #	DESCRIPTION
4441	2	SWITCH	4467	CO-12	GASKET , each
4444 *	11	SWITCH	4469	F-26	GASKET , each
4445	14B	BLOW-OFF VALVE	4470 *	MA-159	QUICK HOOK-UP FTGS
4447 *	21-12	VALVE BODY GASKET , ea.	4471 *	MA-259	Same as above
4448 *	21-30	FLOAT	4477	SA37-30	FLOAT
4446 *	21-109	FLOAT ARM CONNECTOR	4478 *	SA37-38	STRAINER BASKET ASSEMBLY
4449	37-26	BODY GASKET , each	4480	SA47-101-102	VALVE & STRAINER
4450	37-27	Same as above	4482 *	SA51-9	STRAINER ASSEMBLY
4451 *	37-28	Same as above	4484	SA51-101-102	VALVE & STRAINER
4452 *	37-39	STRAINER GASKET , each	4485 *	SA51S-6	VALVE ASSEMBLY
4456 *	51S-114	VALVE SEAT	4488 *	SA67-2	FLOAT & BELLOWS ASSEMBLY
4459	67-12	GASKET , each	4489 *	SA91-60	FLOAT
4460 *	101A-24V-48	TRANSFORMER			
4462	150-14	HEAD GASKET , for flat face flange head (no holes)			
235992	150-14H	HEAD GASKET , for raised face flange head (8 holes)			

FOR ADDITIONAL INFORMATION, VISIT THE
MCDONNELL & MILLER WEBSITE AT www.mcdonnellmiller.com

CONBRACO



STEAM & HYDRONIC SPECIALTIES

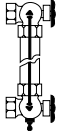
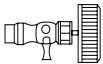
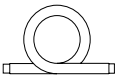
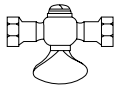

	ID ORDER#	MODEL#	SIZE	DESCRIPTION	* = SPECIAL ORDER ITEM
	1287	13211B15	3/4" x 3/4"	STEAM SAFETY VALVE , 15 PSI, M x F, ASME, rating of 475 lbs	
	1286	13202B15	1" x 1"	<i>Same as above</i> , but 643 lb ASME rating	
	1288	13213B15	1-1/4" x 1-1/2"	<i>Same as above</i> , but 1200 lb ASME rating	
	1289	13214B15	1-1/2" x 2"	<i>Same as above</i> , but 1900 lb ASME rating	
	1285	1220508	2" x 2"	<i>Same as above</i> , but 2500 lb ASME rating	
	1291	2020400	1/2" NPT	GAUGE GLASS SET , self-cleaning rough brass with 5/8" x 12" aluminum wheel, heavy duty pattern	
	201308	9858P12	5/8" x 12"	GAUGE GLASS , "red line"	
	201310 *	9858P18	5/8" x 18"	<i>Same as above</i>	
	201313	9858P36	5/8" x 36"	<i>Same as above</i>	
	1297 *	9831612	3/16" OD x 12" L	GUARD ROD , coppered	
	1300	D160000	5/8"	GAUGE GLASS WASHER, RUBBER	
	1301 *	D160600	3/4"	<i>Same as above</i>	
	1302	E181900	5/8"	GAUGE GLASS WASHER, BRASS	
	1303	2630528	1/2"	COMPRESSION GAUGE COCK , wheel type with soft metal seat/stuffing box	
	1304	2740101	1/4"	BRASS STEAM GAUGE SYPHON , horizontal	
	1305	2740201	1/4"	<i>Same as above</i> , but vertical	
	55453	4149001	1/8"	AIR COCK , male x female, satin brass	
	648	4156005	1/4"	AIR COCK , polished brass, hexagon shoulder, tee handle, FxF	
	12280 *	4210401	1/2"	DRAIN COCK , satin brass, tee handle, MxF, 3/8" opening	



FOR ADDITIONAL INFORMATION, VISIT THE CONBRACO WEBSITE AT www.ap-cfire.com



ID ORDER#	MODEL#	SIZE (IPS) IN OUT	PRESSURE (PSI)	MAX TEMP	TUBE LENGTH	RATING MBTU/HR	CSA CAP. ASME MBTU/HR	
WATER HEATER RELIEF VALVES								* = SPECIAL ORDER ITEM
	211608	17402	3/4M x 3/4F	125	250°F	--	791.0	
	211008	18C40230	3/4M x 3/4F	150	210°F	4"	450.0	
	205776	18C5113150	3/4M x 3/4F	150	210°F	3"	1912.0	
	209407	18C5115150	3/4M x 3/4F	150	210°F	5"	1912.0	
	209812	18C5118150	3/4M x 3/4F	150	210°F	8"	1912.0	
BOILER RELIEF VALVES								
<i>ASME for boilers, heating systems and unfired pressure vessels</i>								
	205936	1060405	3/4F x 3/4F	30	--	--	827.0	
	211013	1060415	3/4F x 3/4F	75	--	--	1686.0	
	231504 *	1060420	3/4F x 3/4F	100	--	--	2162.0	
	207754	1060434	3/4F x 3/4F	150	--	--	3116.0	
	217370	1061405	3/4F x 1F	30	--	--	970.0	
	211129	1061505	1F x 1-1/4F	30	--	--	1570.0	
	214126	1061605	1-1/4F x 1-1/2F	30	--	--	2716.0	
	209814 *	1061705	1-1/2F x 2F	30	--	--	3696.0	
<i>ASME hot water boiler relief valve</i>								
	30633	1040705	3/4M x 3/4F	30	--	--	535.0	
	654912	1010205	3/4F x 1F	30	--	--	710.0	

FOR ADDITIONAL INFORMATION, VISIT THE CONBRACO WEBSITE AT www.ap-cfire.com

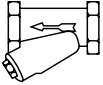

	ID ORDER#	MODEL#	SIZE	DESCRIPTION	* = SPECIAL ORDER ITEM
VACUUM BREAKERS					
	209402	3820301	1/2"	VACUUM BREAKER , anti-siphon, rough brass forged body for hot and cold potable water	
	209403	3820401	3/4"	Same as above	
	207906	3810501	1"	Same as above, but cast body	
	209404	3820306	1/2"	Same as above, but polished chrome finish forged body	
VACUUM RELIEF VALVES					
	205775	3720101	1/2"	VACUUM RELIEF VALVE , for water or steam service, maximum pressure for steam 15 psi, for water 200 psi, 250°F maximum water temperature	
Y-STRAINERS					
	226337	YCT03M20	1/2"	Y-STRAINER , threaded cast iron body, F.I.P. connection, 250# WSP (= #612-013-A1)	
	226354	YCT04M20	3/4"	Same as above (= #612-014-A1)	
	218386	YCT05M20	1"	Same as above (= #612-015-A1)	
	226338	YCT06M20	1-1/4"	Same as above (= #612-016-A1)	
	226340	YCT07M20	1-1/2"	Same as above (= #612-017-A1)	
	226342	YCT08M20	2"	Same as above (= #612-018-A1)	
PARTS & ACCESSORIES FOR BACKFLOW PREVENTERS					
	60689	40003A1	--	REPAIR KIT , for 1/4", 3/8" and 1/2" backflow preventer, "major" kit, <u>with replaceable seats</u>	
	60685	40004A1	--	Same as above, but <u>with replaceable seats</u>	
	60686 *	40004A4	--	RUBBER REPAIR KIT , for 3/4" and 1" backflow preventer, <u>with replaceable seats</u>	





FOR ADDITIONAL INFORMATION, VISIT THE CONBRACO WEBSITE AT www.ap-cfire.com

THERMOSTATIC RADIATOR VALVES & DRAFT REGULATOR

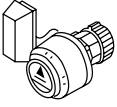
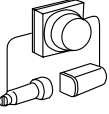
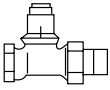
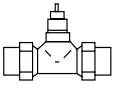

RA2000 Series:

- Individual room control for freestanding radiators, hot water baseboard, convectors in hot water and low temperature steam systems
- Non-electric

	ID ORDER#	MODEL#	SIZE	DESCRIPTION	* = SPECIAL ORDER ITEM
RA2000 SERIES					
	25361	013G8250	--	OPERATOR ONLY , with built-in valve-mounted sensor and dial (requires RA2000 valve body)	
	25362	013G8252	--	OPERATOR ONLY , with valve mounted dial with 6' remote sensor (requires RA2000 valve body)	
	67503	013G8564	--	OPERATOR ONLY , with separate remote-mounted sensor, dial, and two 6' capillary tubes (requires RA2000 valve body)	
	25364	013G8020	3/4"	STRAIGHT VALVE BODY ONLY , with FPT inlet x MPT union tailpiece, 2.7 Cv, for hot water or 2-pipe low pressure steam	
	25367	013G8044	3/4"	STRAIGHT VALVE BODY ONLY , for hot water, C x C with union, 2.7 Cv, for 2-pipe hot water	
	67992	013G8019	3/4"	ANGLE VALVE BODY ONLY , with FPT inlet x MPT union tailpiece, for hot water or 2-pipe low pressure steam	
	67981	013G8018	3/4"	Same as above, but side mounted	
ADAPTERS					
	53741	013G8070	--	ADAPTER , allows RA2000 operator to fit RA valves	
	135595 *	013G8072	--	Same as above, but allows RA2000 operator to fit RAV, BRAVO and VMT valves	
DRAFT REGULATORS					
	11097	065B8900	3/4" NPT	DRAFT REGULATOR , 95°F-203°F range, 3/4" MNPT, self-contained thermostatic expansion control; regulates the temperature of solid fuel boilers without requiring electrical installation or complicated linkage; thermostatic control head senses boiler temperature and adjusts air damper position that controls the combustion air flow (= Tarm #5DSAM)	

FOR ADDITIONAL INFORMATION, VISIT THE DANFOSS WEBSITE AT www.danfoss.com

RA2000 NOTE: The old RAV series is no longer available and has been replaced by the RA2000 series. To use a new #013G8250 or #013G8252 operator with an old series RAV valve body, it is necessary to use a #013G8072 adapter listed above.

HYDROLEVEL HYDRONIC ACCESSORIES



	ID ORDER#	MODEL #	DESCRIPTION
	594601	EW201 (48-201)	ELECTRO-WELL , for use with HydroStat control to activate LWCO function, 3/4 NPT with standard nut, (=Weil-McLain #592-300-026 for WGO boilers)
	594600	3250 (48-3250)	HYDROSTAT UNIVERSAL TEMPERATURE LIMIT AND LOW WATER CUTOFF CONTROL , 120V, 60 hz, may be installed on existing immersion wells, UL listed, (=Weil-McLain #381-300-000); operating range (low limit): off or 110°F-200°F; operating range (high limit): 100°F-220°F; operating range (differential): 10°F-30°F; replaces #3150 (Weil-McLain #381-356-530) (†) to activate the LWCO function, add an Electro-Well
	157511	FS-200 (44-200)	LIQUID FLOW SWITCH , for 1" through 6" pipe, SPDT switch, NEMA-1 rated, 1" NPT pipe connection, adjustable set points, brass body and paddle arms, SPDT, 160 psi maximum pressure 32 F minimum temperature, includes 4 stainless steel paddles (1", 2", 3"-6") (=Lochinvar #100208653, =McDonnell Miller #FS251)
	757680	CG400-2090 (45-410)	LOW WATER CUTOFF—CYCLEGARD , with probe, 24V, automatic reset, 15 second burner off delay, 30 second burner on delay, low water indicating light, direct boiler mounting, intermittent level test every 20 minutes for 90 seconds, for steam boiler applications
	12277	170SV (45-175)	LOW WATER CUTOFF—SAFGARD , with probe, 120V, does not include alarm or manual reset
	12093	24SV (45-245)	Same as above, but 24V
	443093	400 (45-400)	LOW WATER CUTOFF , 24V non-cycling steam primary with 15-second delay (=Weil-McLain #510-811-403)
	235113	550 (45-550)	LOW WATER CUTOFF—SAFGARD , with test button and indirect light, 120V, CSD-1 compliant, water primary/steam secondary, probe-type, manual reset after 30 seconds, 2-second off-time delay, 160 psi water (=Weil-McLain #511-724-281)
	650255	500 (45-500)	Same as above, but 24V (=Weil-McLain #511-724-282)
	587026	1100 (45-1100)	LOW WATER CUTOFF—SAFGARD , with test button lights, 24V, 5 amp relay, auto reset, includes <u>standard wiring harness</u>
	697955	1100H5 (45-1105)	Same as above, but with plug-in wiring harness
	700187	EL1214 (45-214)	PROBE , for #550 and #500 low water cutoffs
	58600	EL1214-SV (45-215)	Same as above, but for #170SV and #24SV low water cutoffs

SEPTEMBER 2024

Line #3321/#4600

HYDROLEVEL HYDRONIC ACCESSORIES

426.1

**HYDROLEVEL
COMPANY**

ID ORDER#	MODEL #	DESCRIPTION
697956	45-531-51	WIRING HARNESS—STANDARD , for #1100 LWCO (=45-531-54)
 617045	45-349	WIRING HARNESS , to connect #1100 LWCO to Lochinvar Knight and Solution boilers and Weil-McLain Ultra Series 3 and ECO boilers. <i>Note: on Lochinvar boilers manufactured before 2007, it may be necessary to ground the Lochinvar low voltage wiring panel for proper operation of the LWCO. See installation sheet for instructions.</i>
617094	45-348	Same as above, but for <u>Weil-McLain GV Series 4</u> boilers only
210624	VXT-24 (45-026)	WATER FEEDER , 24V, fully programmable delay before feed and feed settings (1-5 gallon), with digital feed counter
212349	VXT-120 (45-026)	Same as above, but 120V

FOR ADDITIONAL INFORMATION, VISIT THE HYDROLEVEL WEBSITE AT www.hydrolevel.com



ID ORDER#	MODEL #	SIZE	DESCRIPTION	* = SPECIAL ORDER ITEM
--------------	---------	------	-------------	------------------------

BACKFLOW PREVENTERS — VACUUM BREAKERS



139071	720A	1"	CONTINUOUS PRESSURE FOR IRRIGATION SYSTEMS , pressure vacuum breaker consisting of an approved check valve, vacuum relief, inlet and outlet full port resilient seated shut-off valves and two full port resilient ball valve test cocks; 150 PSI maximum working water pressure; 110°F maximum working water temperature; 300 PSI hydrostatic test pressure; temperature range of 33°F-110°F, ASSE-1020 listed
--------	------	----	--

218181	740	3/8"	CARBONATED BEVERAGE BACKFLOW PREVENTER , <u>lead free</u> , 150 PSI, NSF/ANSI 372 certified
--------	-----	------	--

217972	12-VR10XL	1/2"	VACUUM BREAKER , <u>lead free</u> , all brass body and cap, 250°F maximum working water temperature, 200 PSI maximum working water pressure, 13 CFM capacity, M.I.P., CSA compliance to ANSI A21.22/CSA4.4, for use with #712 C x C x F 3/4" x 3/4" x 1/2" tee in Amtrol boilermate installations
--------	-----------	------	--

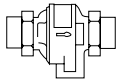

32769	760	1/2" x 1/2"	CONTINUOUS PRESSURE , dual check, with FIP union connections, atmospheric vent drain, 175 PSI maximum pressure, 33°F-210°F temperature range
-------	-----	-------------	---

32469	760	3/4" x 3/4"	<i>Same as above</i>
-------	-----	-------------	----------------------

672347	375XL	1/2" x 1/2"	REDUCED PRESSURE , <u>lead free</u> , with two full port resilient seated ball valves for shut off and four resilient seated ball valves less cocks, 175 PSI maximum working water pressure, 140°F maximum working water temperature, ASSE-1013 listed, UL-classified, NSF listed-Standard 61 Annex G
--------	-------	-------------	--

672360	375XL	3/4" x 3/4"	<i>Same as above</i>
--------	-------	-------------	----------------------

672327	375XL	1" x 1"	<i>Same as above</i>
--------	-------	---------	----------------------

672361	375XL	1-1/4" x 1-1/4"	<i>Same as above</i>
--------	-------	-----------------	----------------------

672362	375XL	1-1/2" x 1-1/2"	<i>Same as above</i>
--------	-------	-----------------	----------------------

672363	375XL	2" x 2"	<i>Same as above</i>
--------	-------	---------	----------------------

BACKFLOW PREVENTER REPAIR PARTS

90084	RK14-975XL	--	COMPLETE REPAIR KIT , for #975XL 1/4", 3/8" and 1/2"
-------	------------	----	---

90085	RK34-975XL	--	<i>Same as above</i> , but for #975XL 3/4" and 1"
-------	------------	----	---

143108 *	RK114-975XL	--	<i>Same as above</i> , but for #975XL 1-1/4" - 2"
----------	-------------	----	---

650337	RK34-375	--	COMPLETE REPAIR KIT , for #375 1/2" and 3/4"
--------	----------	----	---

657539	RK1-375	--	<i>Same as above</i> , but for #375 1"
--------	---------	----	--

657540	RK114-375	--	<i>Same as above</i> , but for #375 1-1/4", 1-1/2" and 2"
--------	-----------	----	---

657541	RK34-375R	--	RUBBER REPAIR KIT , for #375 and #375XL 1/2" and 3/4"
--------	-----------	----	--

657542	RK1-375R	--	<i>Same as above</i> , but for #375 and #375XL 1"
--------	----------	----	---

657543	RK114-375R	--	<i>Same as above</i> , but for #375 and #375XL 1-1/4", 1-1/2" and 2"
--------	------------	----	--

602675	751-13	--	BACKFLOW PREVENTER GASKET , for #760
--------	--------	----	---

FOR ADDITIONAL INFORMATION, VISIT THE ZURN WEBSITE AT www.zurn.com



ID ORDER#	MODEL #	SIZE IN OUT	PRESSURE (PSI)	RELIEF TEMP	PROBE LENGTH	MBTU/HR	ASME MBTU/HR
-----------	---------	-------------	----------------	-------------	--------------	---------	--------------

WATER HEATER T&P RELIEF VALVE

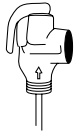

33738	TP1100A-4C-150C	3/4"M x 3/4"F	150	210°F	4"	105.0	500.0
218710	TP1100A-8C-150C	3/4"M x 3/4"F	150	210°F	8"	105.0	500.0
249100	TP1100AE-3C-150C	3/4"M x 3/4"F	150	210 F	3"	105.0	500.0
737825	TP220-5C-125C	3/4"M x 3/4"F	125	210°F	5"	205.0	1,619.0

WATER HEATER STORAGE VESSEL T&P RELIEF VALVE

585494	TP3000-5C-150C	1"F x 1"F	150	210°F	5"	500.0	2,155.0
--------	----------------	-----------	-----	-------	----	-------	---------

BOILER PRESSURE RELIEF VALVE

35034	P1000A-30C	3/4"M x 3/4"F	30	--	--	--	500.0
-------	------------	---------------	----	----	----	----	-------

ID ORDER#	MODEL #	SIZE	DESCRIPTION
-----------	---------	------	-------------

AIR GAPS



616639	AG-11	--	AIR GAP , for #375 1/2", 3/4" and 1"
616642	AG-12	--	Same as above, but for 1-1/4", 1-1/2" and 2"

ID ORDER#	MODEL #	DESCRIPTION
-----------	---------	-------------

AQUA—GARD THERMOSTATIC MIXING VALVE

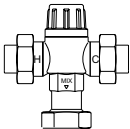

675232	34-ZW1070XL-C	AQUA-GARD THERMOSTATIC MIXING VALVE, lead free, 3/4", 10 gpm, 145 psi maximum working pressure, 95°F- 115°F outlet temperature range, union sweat, ASSE-1070 listed
674326	38-ZW3870XLT-4P	Same as above, but 3/8", 3.1 gpm, universal 3 or 4 port, and compression fittings

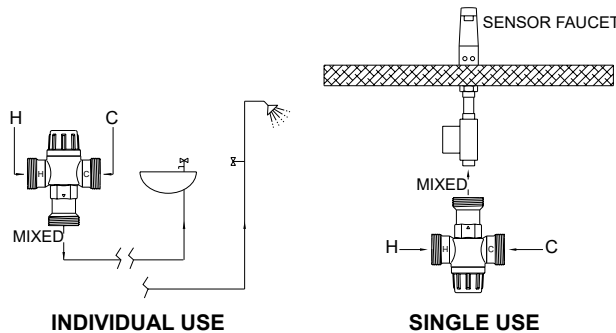

FOR ADDITIONAL INFORMATION, VISIT THE ZURN WEBSITE AT www.zurn.com

SPARCO

THERMOSTATIC MIXING VALVES



ID ORDER#	MODEL #	SIZE	DESCRIPTION
-----------	---------	------	-------------

THERMOSTATIC MIXING VALVES—PLUMBING



756757 AM100C1070-US-1LF 1/2" Union Sweat

THERMOSTATIC PROPORTIONAL MIXING VALVE, for point-of-use installation, provides anti-scald, anti-chill protection and meets the requirements of ASSE 1017 and 1070, 212°F maximum supply temperature, 150° PSI maximum working pressure, 80°-120°F operating temperature range, 0.5 minimum flow requirement, 8 gpm maximum flow, 3.9 Cv capacity, lead free

682560 AM101C1070-US-1LF 3/4" Union Sweat

Same as above, but 70°-120°F, 1.8 Cv capacity



682561 AM102C-US-1LF 1" Union Sweat

WHILE SUPPLIES LAST

THERMOSTATIC PROPORTIONAL MIXING VALVE, nickel-plated brass construction, 70°- 120°F operating temperature range, 212°F maximum supply temperature, 150 psi maximum working pressure, meets ASSE 1017 requirement, 3.9 Cv capacity, lead free

757335 AM102C1070-US-1LF 1" Union Sweat

Same as above, but meets ASSE 1017 and ASSE 1070 requirement and 1.8 CV



716590 AM100C1070-UPEX1LF 1/2" Union PEX

THERMOSTATIC MIXING VALVE, Teflon-coated, nickel-plated brass construction, 70°- 120°F operating temperature range, 212°F maximum supply temperature, 150 psi maximum working pressure, meets ASSE 1017 requirement, 3.9 Cv capacity, lead free

THERMOSTATIC MIXING VALVES—HEATING ONLY



465453 AM101R-US-1 3/4" Union Sweat

THERMOSTATIC PROPORTIONAL MIXING VALVE—HEATING ONLY, no ASSE approval, 80°-180°F operating temperature range, 212°F maximum supply temperature, 150 psi maximum working pressure, 3.9 Cv capacity

FOR ADDITIONAL INFORMATION, VISIT THE SPARCO (HONEYWELL) WEBSITE AT www.customer.honeywell.com

SPARCO

AIR ELIMINATORS & PARTS



ID ORDER#	MODEL #	INLET CONNECTION	NPT SIZE	DESCRIPTION	* = SPECIAL ORDER ITEM
--------------	---------	---------------------	-------------	-------------	------------------------

SUPERVENT AIR ELIMINATORS (SEPARATORS)



Eliminates all micro bubbles, trapped air and dirt from heating and cooling systems, bronze construction with stainless steel concentrator, maximum temperature of 239°F/125 PSI, 2"-8" temperature/pressure 250°F/150 PSI, fully serviceable top and bottom. They are available in blow down version, either threaded or flanged, and in cleanable version, flanged with bottom pullout. Made in the USA, 1 year warranty.

158003 *	PV075	Threaded	3/4"	Same as above
169773	PV100	Threaded	1"	Same as above
169775	PV125	Threaded	1-1/4"	Same as above
169770	PV150	Threaded	1-1/2"	Same as above
153602	PV200	Threaded	2"	Same as above
169776 *	PV075S	Sweat	3/4"	Same as above
169672	PV100S	Sweat	1"	Same as above
169673	PV125S	Sweat	1-1/4"	Same as above
756032	PV100P	Press	1"	Same as above
756033	PV125P	Press	1-1/4"	Same as above

PARTS

193313	PV001RP	REBUILD KIT , replacement top air vent assembly with float; for Powervent® air eliminators manufactured prior to 2004
566757	PV020RP	REPAIR KIT , MH1, vent top assembly and float

PRODUCT INFORMATION					
PRODUCT NUMBER	SIZE (IN.)	DIMENSION			CV
		A	B	C	
PV075	3/4" NPT	7.4"	2.7"	1.9"	13
PV100	1" NPT	8.1"	3.2"	2.1"	22
PV125	1-1/4" NPT	8.4"	3.7"	2.5"	38
PV150	1-1/2" NPT	9.7"	4.3"	3.1"	53
PV200	2" NPT	10.7"	2.5"	4.0"	95
PV075S	3/4" Sweat	7.4"	3.2"	1.9"	13
PV100S	1" Sweat	8.1"	3.7"	2.1"	22
PV125S	1-1/4" Sweat	8.4"	4.4"	2.5"	38
PV100P	1" Press	8.1"	6.4"	2.1"	22
PV125P	1-1/4" Press	8.4"	7.5"	2.5"	38

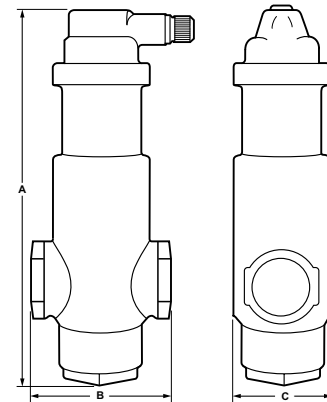

FOR SPARCO MIXING VALVES, SEE PAGE 427

FOR SPARCO DIAL THERMOMETER, SEE PAGE 419

OATEY

WATER HEATER PANS and WASHING MACHINE PANS

	ID ORDER#	MODEL#	SIZE	DESCRIPTION
	603184	34171	20"	ALUMINUM WATER HEATER PAN , 2" depth, includes 1" outlet and CPVC adapters, provides fireproof and safe solution to the problem of a leaking hot water heater
	603185	34172	22"	<i>Same as above, but 22"</i>
	603186	34173	24"	<i>Same as above, but 24"</i>
	706919	34174	26"	<i>Same as above, but 26"</i>
	603187	34175	30"	<i>Same as above, but 30"</i>

FOR WET SWITCH FLOOD DETECTOR, SEE 500 SECTION

FOR ADDITIONAL INFORMATION, VISIT THE OATEY WEBSITE AT www.oatey.com

500 SECTION

**Furnaces — Fans —
Air Conditioning**

500 SECTION INDEX

Airex	511	Liquid Line Driers	510
American Warming	527	Mammoth	507-507.1
Aprilaire	537-537.4	Maytag	505-505.19
Aspen	501-501.2	Maxipro	see 100 section
Atco Flex-Duct	526	Miller	504-504.23
BestAir Pro	536	Nortek	508-508.11
Broan	535	Panasonic	500-500.17, 534-534.1
Builder's Best	532	Purolator	541-541.1
Cover Guard (Rectorseal/Fortress)	512	Rectorseal	512 (also see 100 and 300 sections)
Diversitech	513-513.3 (also see 300 section)	Refrigeration and A/C Accessories	510.2
Durodyne	524-524.2	Renewairst	519-519.1
Dust-Free	540	Reznor	503-503.8
Empire	516-516.4	Rinnai	515 (also see 500 section)
E-Z Aire	518-518.1	Seal-Tite	520-520.9
Fantech	533	Selkirk	528-528.6
Field Controls	531	Sight Glass Indicators	510.1
Fortress (Rectorseal)	512.1	Southwark	521-521.9
Galvanized Flat Sheets	523	Supreme Stands	542
General Filters (GeneralAire)	538-538.2 (also see 600 section)	Supco	514-514.5
Gibson	506-506.11	Supreme Stands	542
Hardcast	525	Trion	539
Hart & Cooley	517-517.7, 530-530.1	Thermopan	522
Heatfab	529-529.2	Tjernlund	536
Insulation & Adhesive Products	527	Venting Products	532
Johns Manville	527	White Mountain Hearth	516.3-516.4
Linesets	509		

PANASONIC

YE PRO SERIES HEAT PUMPS

SINGLE-ZONE - WALL MOUNT



- Wall-mounted, single zone
- 115V, 60Hz
- Low ambient operation down to -13°F
- Econavi mono sensor
- R-410A refrigerant
- Wireless remote controller
- Includes base pan heater
- Microprocessor-controlled operation
- Self-diagnosing function
- Dry mode
- Quiet mode
- Automatic heating and cooling changeover
- Hot start heating system
- 5 fan speeds and automatic fan operation
- Air sweep and louver controls
- 24-hour clock with "on/off" program timer
- Blue fin condenser
- Washable, anti-microbial filter
- Automatic restart function after power failure
- Electric expansion valve



RECOMMENDED ACCESSORY:

#RSH-50 Surge Protector (required for Gold Level Contractor 12-year installations)

RESIDENTIAL WARRANTY

- 7 year compressor
- 5 year parts other than compressor

ID ORDER#	MODEL#	INDOOR UNIT	OUTDOOR UNIT	SEER	NOM. TON.	LINESET
762799	YE9WKU1	CS-YE9WKU1	CU-YE9WKU1	20.0	0.75	1/4" x 3/8"
762804	YE12WKU1	CS-YE12WKU1	CU-YE12WKU1	20.0	1.00	1/4" x 3/8"

YE PRO SERIES OPERATION RANGE			
	Temperature	Indoor Air Intake Temp.	Outdoor Air Intake Temp.
Cooling	Maximum	89.6°F DB / 73.4°F WB	114.8°F DB
	Minimum	60.8°F DB / 51.8°F WB	0°F DB
Heating	Maximum	86°F DB / -°F WB	75.2°F DB / 64.4°F WB
	Minimum	60.8°F DB / -°F WB	-13°F DB / -2.2°F WB

FOR SPECIFICATIONS, SEE PAGE 500.1

FOR ACCESSORIES, SEE PAGE 500.17

FOR ADDITIONAL INFORMATION, VISIT THE PANASONIC WEBSITE AT www.panasonic.com

PANASONIC

YE PRO SERIES HEAT PUMPS (YE9WKU1 — YE12WKU1) SPECIFICATIONS



YE PRO SERIES WALL-MOUNT HEAT PUMPS					
Model No.		YE9WKU1		YE12WKU1	
Unit Model No.		Indoor Unit CS-YE9WKU1	Outdoor Unit CU-YE9WKU1	Indoor Unit CS-YE12WKU1	Outdoor Unit CU-YE12WKU1
Performance & Electrical Ratings					
Capacity	Cooling	Btu/h	9,000		12,000
	Heating	Btu/h	9,500 (5,960 - 10,106)		12,000 (7,018 - 12,136)
Moisture Removal	High	Pints/H	TBD		TBD
Dry Air Flow	Hi/Med/Lo	CFM	TBD		TBD
SEER	Cooling		20.0		20.0
EER	Cooling		12.0		10.5
HSPF	Heating		10.5		10.0
Power Supply	V, Phase, Hz		115V, 1PH, 60Hz		115V, 1PH, 60Hz
Running Amps	Cooling	A	TBD		TBD
	Heating	A	TBD		TBD
Power Input	Cooling	W	TBD		TBD
	Heating	W	TBD		TBD
Back-up Heater		kW	TBD		TBD
Fuse or Circuit Breaker Capacity		A	25		30
Features					
Controls		Microprocessor		Microprocessor	
Low Ambient Control		Equipped		Equipped	
Wireless Remote Controller		Included		Included	
Wired Remote Controller		N/A		N/A	
Fan Speeds		5 Speeds + Auto		5 Speeds + Auto	
Timer		24-hr Program		24-hr Program	
Air Deflection	Horizontal	Automatic, Sweep, Step		Automatic, Sweep, Step	
	Vertical	Automatic, Sweep, Step		Automatic, Sweep, Step	
Air Filter		Washable + Anti-microbial filter		Washable + Anti-microbial filter	
Refrigerant		R-410A		R-410A	
Refrigerant Control		Electric Expansion Valve		Electric Expansion Valve	
Operation Sound	In(Hi/Me/Lo/Qt) dB-A	38 / 35 / 32		40 / 37 / 34	
	Outdoor (Hi) dB-A	50		53	
Refrigerant Piping	Type	Flare		Flare	
	Discharge	inches	1/4"		1/4"
	Suction	inches	3/8"		3/8"
Refrigerant Pipe Length		Ft.	Max. 49.0		Max. 49.0
Elevation Dif.**	Outdoor Above	Ft.	TBD		TBD
	Outdoor Below	Ft.	TBD		TBD
Dimensions & Weight					
Height		inches	8.07	11.22	8.07
Width		inches	31.92	28.66	31.92
Depth		inches	11.49	21.65	11.49
Net Weight		Lbs.	17.6	59.5	17

Important: You must use refrigerant piping rated for R-410A.

* This is maximum elevation difference when the indoor unit is located above the outdoor unit.

FOR ADDITIONAL INFORMATION, VISIT THE PANASONIC WEBSITE AT www.panasonic.com

PANASONIC

DELUXE SERIES EXTERIOS HEAT PUMPS

SINGLE-ZONE - WALL MOUNT



- Wall-mounted, single zone
- Econavi mono sensor
- R-410A refrigerant
- Wireless remote controller
- Microprocessor-controlled operation
- Low ambient operation
- Self-diagnosing function
- Dry mode
- Quiet mode
- Automatic heating and cooling changeover
- Hot start heating system
- 5 fan speeds and automatic fan operation
- Air sweep and louver controls
- 24-hour clock with "on/off" program timer
- Blue fin condenser
- Washable, anti-microbial filter
- Automatic restart function after power failure
- Electric expansion valve



RESIDENTIAL WARRANTY

- 7 year compressor
- 30 days labor, compressor only
- 5 year parts other than compressor
- 1 year controller

RECOMMENDED ACCESSORY:

#RSH-50 Surge Protector (required for Gold Level Contractor 12-year installations)

ID ORDER#	MODEL#	INDOOR UNIT	OUTDOOR UNIT	SEER	NOM. TON.	LINESET	REQUIRED ACCESSORIES
715295	E9RKUA	CS-E9RKUAW	CU-E9RKUA	23.0	0.75	1/4" x 3/8"	#19173 Yellow Jacket adapter
713976	E12RKUA	CS-E12RKUAW	CU-E12RKUA	22.5	1.00	1/4" x 1/2"	#19173 Yellow Jacket adapter
700810	E18RKUA	CS-E18RKUAW	CU-E18RKUA	19.5	1.50	1/4" x 1/2"	#19173 Yellow Jacket adapter
700811	E24RKUA	CS-E24RKUAW	CU-E24RKUA	19.0	2.00	1/4" x 5/8"	#19173 Yellow Jacket adapter

DELUXE "E" SERIES OPERATION RANGE			
	Temperature	Indoor Air Intake Temp.	Outdoor Air Intake Temp.
Cooling	Maximum	90°F DB / 74°F WB	115°F DB / 79°F WB
	Minimum	61°F DB / 52°F WB	0°F DB / -°F WB
Heating	Maximum	86°F DB / -°F WB	75°F DB / 64°F WB
	Minimum	61°F DB / -°F WB	-5°F DB / -6.8°F WB

FOR SPECIFICATIONS, SEE PAGE 500.3

FOR ACCESSORIES, SEE PAGE 500.17

FOR ADDITIONAL INFORMATION, VISIT THE PANASONIC WEBSITE AT www.panasonic.com

PANASONIC

DELUXE SERIES EXTERIOS HEAT PUMPS (SINGLE ZONE) SPECIFICATIONS



DELUXE SERIES WALL-MOUNT HEAT PUMPS											
Model No.	E9RKUA			E12RKUA			E18RKUA		E24RKUA		
Unit Model No.	Indoor Unit	Outdoor Unit	Indoor Unit	Outdoor Unit	Indoor Unit	Outdoor Unit	Indoor Unit	Outdoor Unit	Indoor Unit	Outdoor Unit	
	CS-E9RKUAW	CU-E9RKUA	CS-E12RKUAW	CU-E12RKUA	CS-E18RKUAW	CU-E18RKUA	CS-E24RKUAW	CU-E24RKUA	CS-E24RKUAW	CU-E24RKUA	
Performance & Electrical Ratings											
Capacity	Cooling	Btu/h	9,000 (4,100-10,200)		11,500 (4,100-13,300)		17,200 (5,800-19,800)		24,000 (5,800-27,200)		
	Heating	Btu/h	12,000 (4,100-14,100)		13,800 (4,100-16,300)		21,600 (5,800-22,000)		28,800 (5,800-29,200)		
Moisture Removal	High	Pints/H	1.3		1.7		3.0		7.6		
Dry Air Flow	Hi/Med/Lo	CFM	425		450		670		670		
SEER	Cooling		23.0		22.5		19.5		19.0		
EER	Cooling		13.0		12.5		13.2		10.2		
HSPF	Heating		11.0		11.0		10.0		10.0		
Power Supply	V, Phase, Hz		230 / 208V, 1PH, 60Hz		230 / 208V, 1PH, 60Hz		230 / 208V, 1PH, 60Hz		230 / 208V, 1PH, 60Hz		
Running Amps	Cooling	A	3.2 / 3.6		4.2 / 4.7		6.3 / 7.0		10.8 / 11.9		
	Heating	A	5.1 / 5.7		5.6 / 6.3		8.3 / 9.3		11.4 / 12.6		
Power Input	Cooling	W	690 (250-850)		920 (250-1,150)		1,300 (430-1,600)		2,350 (430-2,720)		
	Heating	W	1,200 (200-1,500)		1,250 (250-1,710)		1,750 (380-1,800)		2,500 (380-2,660)		
Back-up Heater		kW	--		--		--		--		
Fuse or Circuit Breaker Capacity		A	15		15		20		25		
Features											
Controls	Microprocessor										
Low Ambient Control	Equipped										
Wireless Remote Controller	Included										
Wired Remote Controller (optional)	CZ-RD516C-1										
Fan Speeds	5 Speeds + Auto										
Timer	24-hr Program										
Air Deflection	Horizontal	Manual									
	Vertical	Automatic									
Air Filter	Washable + Anti-microbial filter										
Refrigerant	R-410A										
Refrigerant Control	Electric Expansion Valve										
Operation Sound	In(Hi/Me/Lo/Qt) dB-A	42 / 29 / 26		44 / 35 / 32		47 / 39 / 36		48 / 40 / 37			
	Outdoor (Hi) dB-A	48		49		49		51			
Refrigerant Piping	Type	Flare									
	Discharge	inches	1/4		1/4		1/4		1/4		
	Suction	inches	3/8		1/2		1/2		5/8		
Refrigerant Pipe Length	Ft.	Max. 65.6		Max. 65.6		Max. 100		Max. 100			
Elevation Dif.**	Outdoor Above	Ft.	Max. 49.2		Max. 49.2		Max. 49.2		Max. 49.2		
	Outdoor Below	Ft.	Max. 49.2		Max. 49.2		Max. 49.2		Max. 49.2		
Dimensions & Weight											
Height	inches	11-7/16	21-9/32	11-7/16	21-9/32	11-7/16	31-5/16	11-7/16	31-5/16		
Width	inches	34-9/32	30-23/32	34-9/32	30-23/32	42-5/32	34-15/32	42-5/32	34-15/32		
Depth	inches	8-7/16	11-13/32	8-7/16	11-13/32	9-15/32	12-5/8	9-15/32	12-5/8		
Net Weight	Lbs.	20	82	20	82	26	132	26	132		

Important: You must use refrigerant piping rated for R410A.

* This is maximum elevation difference when the indoor unit is located above the outdoor unit.

Panasonic 2018 Full Line Catalog

FOR ADDITIONAL INFORMATION, VISIT THE PANASONIC WEBSITE AT www.panasonic.com

PANASONIC

CLIMAPURE XE SERIES HEAT PUMPS

SINGLE-ZONE - WALL MOUNT



- Wall-mounted, single zone
- Nanoe X built-in air and surface multi-step purification technology
- -15°F cold climate heating operation
- R-410A refrigerant
- Built-in wifi with Panasonic control app
- Room freeze protection
- Wireless remote controller
- Microprocessor-controlled operation
- Low ambient operation
- Self-diagnosing function
- Dry mode
- Quiet mode
- Automatic heating and cooling changeover
- Hot start heating system
- Base pan heater
- 5 fan speeds and automatic fan operation
- Air sweep and louver controls
- 24-hour clock with "on/off" program timer
- Blue fin condenser
- Washable, anti-microbial filter
- Automatic restart function after power failure
- Electric expansion valve
- Auxiliary heat connect



RECOMMENDED ACCESSORY:

#RSH-50 Surge Protector (required for Gold Level Contractor 12-year installations)

RESIDENTIAL WARRANTY

- 7 year compressor
- 30 days labor, compressor only
- 5 year parts other than compressor
- 1 year controller

ID ORDER#	MODEL#	INDOOR UNIT	OUTDOOR UNIT	SEER	NOM. TON.	LINESET	REQUIRED ACCESSORIES
747264	XE9WKUA	CS-XE9WKUAW	CU-XE9WKUA	28.1	0.75	1/4" x 3/8"	#19173 Yellow Jacket adapter
747268	XE12WKUA	CS-XE12WKUAW	CU-XE12WKUA	24.6	1.00	1/4" x 1/2"	#19173 Yellow Jacket adapter
747136	XE15WKUA	CS-XE15WKUAW	CU-XE15WKUA	20.3	1.25	1/4" x 1/2"	#19173 Yellow Jacket adapter
747270	XE18WKUA	CS-XE18WKUAW	CU-XE18WKUA	21.0	1.50	1/4" x 1/2"	#19173 Yellow Jacket adapter
747272	XE24WKUA	CS-XE24WKUAW	CU-XE24WKUA	20.0	2.00	1/4" x 5/8"	#19173 Yellow Jacket adapter

* = SPECIAL ORDER ITEM

FOR SPECIFICATIONS, SEE PAGES 500.5 AND 500.6

FOR ACCESSORIES, SEE PAGE 500.17

FOR ADDITIONAL INFORMATION, VISIT THE PANASONIC WEBSITE AT www.panasonic.com

PANASONIC

CLIMAPURE XE SERIES HEAT PUMPS (XE9WKUA — XE15WKUA)

SPECIFICATIONS



CLIMAPURE XE SERIES WALL-MOUNT HEAT PUMPS

Model No.	XE9WKUA		XE12WKUA		XE15WKUA	
Unit Model No.	Indoor Unit CS-XE9WKUAW	Outdoor Unit CU-XE9WKUA	Indoor Unit CS-XE12WKUAW	Outdoor Unit CU-XE12WKUA	Indoor Unit CS-XE15WKUAW	Outdoor Unit CU-XE15WKUA
Performance & Electrical Ratings						
Capacity	Cooling	Btu/h	8,700 (2,800-12,000)		14,700 (3,300-19,000)	
	Heating	Btu/h	10,900 (3,000-18,000) (8,000 at 17°F)		17,200 (3,300-24,000) (11,000 at 17°F)	
Moisture Removal	High	Pints/H	1.3		4.0	
Dry Air Flow	High CFM		380		430	
SEER	Cooling		28.20		21.10	
EER	Cooling		16.10		12.55	
HSPF	Heating		14.50		12.00	
Power Supply	V, Phase, Hz		230 / 208V, 1PH, 60Hz		230 / 208V, 1PH, 60Hz	
Running Amps	Cooling	A	2.6 / 2.9		5.4 / 6.0	
	Heating	A	3.2 / 3.6		5.8 / 6.6	
Power Input	Cooling	W	540		1,170	
	Heating	W	670		1,260	
Base Pan Heater	W		80		80	
Min. Circuit Ampacity	A		15		20	
Features						
Controls	Microprocessor		Microprocessor		Microprocessor	
Low Ambient Control	Equipped		Equipped		Equipped	
Wireless Remote Controller	Included		Included		Included	
Wired Remote Controller (optional)	CZ-RD516C-1		CZ-RD516C-1		CZ-RD516C-1	
Fan Speeds	5 Speeds + Auto		5 Speeds + Auto		5 Speeds + Auto	
Timer	24-hr Program		24-hr Program		24-hr Program	
Air Deflection	Horizontal	Automatic	Automatic		Automatic	
	Vertical	Automatic	Automatic		Automatic	
Air Filter	Washable + Anti-microbial filter		Washable + Anti-microbial filter		Washable + Anti-microbial filter	
Refrigerant	R-410A		R-410A		R-410A	
Refrigerant Control	Electric Expansion Valve		Electric Expansion Valve		Electric Expansion Valve	
Operation Sound	In(Hi/Me/Lo/Qt) dB-A		42 / 25 / 20		45 / 28 / 20	
	Outdoor (Hi) dB-A		48		51	
Refrigerant Piping	Type	Flare	Flare		Flare	
	Discharge	inches	1/4"		1/4"	
	Suction	inches	3/8"		1/2"	
Refrigerant Pipe Length	Ft.		Max. 65.6		Max. 65.6	
Elevation Dif.**	Outdoor Above	Ft.	Max. 49.2		Max. 49.2	
	Outdoor Below	Ft.	Max. 49.2		Max. 49.2	
Dimensions & Weight						
Height	inches	Indoor Unit 11-5/8	Outdoor Unit 24-1/2	Indoor Unit 11-5/8	Outdoor Unit 24-1/2	Indoor Unit 11-5/8
Width	inches	34-9/32	32-15/32	34-9/32	32-15/32	34-15/32
Depth	inches	9-1/16	11-25/32	9-1/16	11-25/32	12-5/8
Net Weight	Lbs.	24	82	24	82	106

Important: You must use refrigerant piping rated for R-410A.

* This is maximum elevation difference when the indoor unit is located above the outdoor unit.

PAC19343FLY (5/20)

FOR ADDITIONAL INFORMATION, VISIT THE PANASONIC WEBSITE AT www.panasonic.com

PANASONIC

CLIMAPURE XE SERIES HEAT PUMPS (XE18WKUA — XE24WKUA)

SPECIFICATIONS



CLIMAPURE XE SERIES WALL-MOUNT HEAT PUMPS

Model No.	XE18WKUA		XE24WKUA	
Unit Model No.	Indoor Unit CS-XE18WKUAW	Outdoor Unit CU-XE18WKUA	Indoor Unit CS-XE24WKUAW	Outdoor Unit CU-XE24WKUA
Performance & Electrical Ratings				
Capacity	Cooling	Btu/h	17,200 (5,800-19,800)	
	Heating	Btu/h	20,400 (5,800-30,000) (14,000 at 17°F)	
Moisture Removal	High	Pints/H	3.6	
Dry Air Flow	Hi/Med/Lo	CFM	560	
SEER	Cooling		21.0	
EER	Cooling		13.2	
HSPF	Heating		12.0	
Power Supply	V, Phase, Hz		230 / 208V, 1PH, 60Hz	
Running Amps	Cooling	A	6.2 / 6.9	
	Heating	A	7.7 / 8.7	
Power Input	Cooling	W	1300	
	Heating	W	1630	
Back-up Heater		kW	80	
Fuse or Circuit Breaker Capacity		A	20	
Features				
Controls	Microprocessor		Microprocessor	
Low Ambient Control	Equipped		Equipped	
Wireless Remote Controller	Included		Included	
Wired Remote Controller (optional)	CZ-RD516C-1		CZ-RD516C-1	
Fan Speeds	5 Speeds + Auto		5 Speeds + Auto	
Timer	24-hr Program		24-hr Program	
Air Deflection	Horizontal	Automatic	Automatic	
	Vertical	Automatic	Automatic	
Air Filter	Washable + Anti-microbial filter		Washable + Anti-microbial filter	
Refrigerant	R-410A		R-410A	
Refrigerant Control	Electric Expansion Valve		Electric Expansion Valve	
Operation Sound	In(Hi/Me/Lo/Qt) dB-A	47 / 39 / 36		49 / 40 / 37
	Outdoor (Hi) dB-A	52		53
Refrigerant Piping	Type	Flare		Flare
	Discharge	inches	1/4"	
	Suction	inches	1/2"	
Refrigerant Pipe Length		Ft.	Max. 100.0	
Elevation Dif.**	Outdoor Above	Ft.	Max. 49.2	
	Outdoor Below	Ft.	Max. 49.2	
Dimensions & Weight				
Height	inches	Indoor Unit 11-29/32	Outdoor Unit 31-5/16	Indoor Unit 11-29/32
Width	inches	43-13/32		Outdoor Unit 34-15/32
Depth	inches	9-5/8		12-5/8
Net Weight	Lbs.	33		132

Important: You must use refrigerant piping rated for R-410A.

* This is maximum elevation difference when the indoor unit is located above the outdoor unit.

PAC19343FLY (5/20)

FOR ADDITIONAL INFORMATION, VISIT THE PANASONIC WEBSITE AT www.panasonic.com

PANASONIC

MULTI-ZONE SYSTEMS

DUAL ZONE - 1.5 TON

500.7



- 2 zones
- 18 SEER
- Blue fin condenser
- DC twin rotary compressor
- Inverter technology
- Ductless zone control
- Electric expansion valve
- R-410A refrigerant

RESIDENTIAL WARRANTY

- 7 year compressor
- 30 days labor, compressor only
- 5 year parts other than compressor
- 1 year controller



CU-2E18SBU-5 OUTDOOR UNIT



RECOMMENDED ACCESSORY:

#RSH-50 Surge Protector (required for Gold Level Contractor 12-year installations)

ID ORDER#	MODEL#	SEER	NOM. TON.	LINESET	REQUIRED ACCESSORIES
OUTDOOR UNITS					
732614	CU-2E18SBU-5	19.0	1.5	--	--
INDOOR UNITS					
700815	CS-ME7RKUA	--	.58	1/4" x 3/8"	#19173 Yellow Jacket adapter
700812	CS-E9RKUAW	--	.75	1/4" x 3/8"	#19173 Yellow Jacket adapter
700813	CS-E12RKUAW	--	1.0	1/4" x 3/8"	(1) #19173 Yellow Jacket adapter + (1) #CZ-MA1P copper reducing fitting

CU-2E18SBU-5 MULTI-ZONE OPERATION RANGE			
	Temperature	Indoor Air Intake Temp.	Outdoor Air Intake Temp.
Cooling	Maximum	90°F DB / 74°F WB	115°F DB / 79°F WB
	Minimum	61°F DB / 52°F WB	14°F DB / -°F WB
Heating	Maximum	86°F DB / -°F WB	75.2°F DB / 64.4°F WB
	Minimum	61°F DB / -°F WB	-5°F DB / -6.8°F WB

FOR SPECIFICATIONS, SEE PAGE 500.8

FOR ACCESSORIES, SEE PAGE 500.17

FOR ADDITIONAL INFORMATION, VISIT THE PANASONIC WEBSITE AT www.panasonic.com

PANASONIC MULTI-ZONE SYSTEMS (DUAL ZONE - 1.5 TON) SPECIFICATIONS



DUAL ZONE (1.5 TON) OUTDOOR UNIT

Model No.		CU-2E18SBU-5	
Performance		Cooling	Heating
Capacity	Btu/h	16,700 (7,200-20,000)	20,200 (7,200-24,600)
Air Circulation	High CFM	1,447	1,447
Number of Connectable Indoor Units		2	2
SEER	Non-Ducted/Ducted	19.0 / 19.0	--
EER	Non-Ducted/Ducted	12.55 / 12.55	--
HSPF	Non-Ducted/Ducted	--	9.5 / 9.0
Electrical Rating			
Power Supply	V, Phase, Hz	230V/208V, 1PH, 60Hz	230V/208V, 1PH, 60Hz
Running Ampere	Non-Ducted/Ducted A	6.6-6.0 / 6.6-6.0	8.5 / 7.8 / 8.5-7.8
Power Input	W	1,330	1,750
Maximum Fuse Size	Amps	20 / 25	20 / 25
Features			
Controls		Microprocessor	Microprocessor
Fan Speeds		Variable Speed	Variable Speed
Compressor		DC Inverter	DC Inverter
Refrigerant / Amount Charged at Shipment		R-410A / 78.70 oz.	R-410A / 78.70 oz.
Refrigerant Control		Electric Expansion Valve	Electric Expansion Valve
Operation Sound Hi	dB-A	48	49
Refrigerant Tubing Connections	Type	Flare	Flare
Max. Allowable Tubing Length	Ft.	164 per system (82 per unit)	164 per system (82 per unit)
Refrigerant	Discharge inches	(2) 1/4	(2) 1/4
Tub Diameter	Suction inches	(2) 3/8	(2) 3/8
Required Adapter		(1) CZ-MA1P for indoor 12K Btu/hr units	(1) CZ-MA1P for indoor 12K Btu/hr units
Dimensions & Weight			
Unit Dimensions	H x W x D inches	31-5/16 x 34-15/32 (+3-3/4) x 14-3/16	31-5/16 x 34-15/32 (+3-3/4) x 14-3/16
Net Weight	lbs.	157	157

Important: You must use refrigerant piping rated for R410A. * Test conditions based on AHRI 210/240.

Panasonic 2018 Full Line Catalog

WALL MOUNT INDOOR UNITS

Model No.			CS-ME7RKUA	CS-E9RKUAW	CS-E12RKAUW	CS-E18RKUAW	CS-E24RKUAW
Performance & Electrical Ratings							
Capacity	Cooling	Btu/h	6,900 (6,100-9,900)	8,600 (6,100-9,000)	10,900 (6,100-13,000)	17,100 (6,500-19,800)	24,000 (5,800-27,200)
	Heating	Btu/h	10,900 (4,100-14,000)	12,300 (4,100-14,700)	15,300 (4,100-19,800)	23,400 (19,400-4,100)	28,800 (5,800-29,200)
Moisture Removal	High	Pints/H	0.8	1.1	1.3	3.0	7.6
Dry Air Flow	High	CFM	425	430	475	680	715
Power Supply	V, Phase, Hz		230V/208V, 1PH, 60Hz	230V/208V, 1PH, 60Hz	230V/208V, 1PH, 60Hz	230V/208V, 1PH, 60Hz	230V/208V, 1PH, 60Hz
Running Amps	Cooling	A	2.5 / 2.8	3.2 / 3.5	3.9 / 4.3	7.2 / 8.0	10.8 / 11.9
	Heating	A	3.7 / 4.1	4.7 / 5.2	6.0 / 6.6	8.3 / 9.3	11.4 / 12.6
Power Input	Cooling	W	500 (340-810)	630 (340-810)	800 (340-1,360)	1,300 (430-1,600)	2,350 (430-2,720)
	Heating	W	740 (300-1,230)	940 (300-1,230)	1,230 (200-2,100)	1,750 (380-1,800)	2,500 (380-2,660)
Operation Sound (Hi/Me/Lo/Q-Lo)	Cooling		39 / 25	40 / 25	43 / 28	47 / 39 / 36	48 / 40 / 37
	Heating		41 / 29	42 / 29	44 / 35 / 32	46 / 39 / 36	48 / 40 / 37
Refrigerant Tube Diameter	Discharge	inches	1/4	1/4	1/4	1/4	1/4
	Suction	inches	3/8	3/8	3/8	3/8	1/2
Required Adapters			none	none	CZ-MA1P	CZ-MA1P	CZ-MA2P and CZ-MA3P
Dimensions & Weight							
Height	inches		11-7/16	11-7/16	11-7/16	11-7/16	11-7/16
Width	inches		34-9/32	34-9/32	34-9/32	42-5/32	42-5/32
Depth	inches		8-7/16	8-7/16	8-7/16	9-15/32	9-15/32
Net Weight	lbs.		20	20	20	26	26

Important: You must use refrigerant piping rated for R410A. *This is maximum elevation difference when the indoor unit is located above the outdoor unit.

PANASONIC

MULTI-ZONE SYSTEMS

2 to 4 ZONES - 2 TON



- 2 to 4 zones
- 22 SEER
- Blue fin condenser
- DC twin rotary compressor
- Inverter technology
- Ductless zone control
- Electric expansion valve
- R-410A refrigerant

RESIDENTIAL WARRANTY

- 7 year compressor
- 30 days labor, compressor only
- 5 year parts other than compressor
- 1 year controller

RECOMMENDED ACCESSORY:

#RSH-50 Surge Protector (required for Gold Level Contractor 12-year installations)



CU-4E24RBU-5 OUTDOOR UNIT



ID ORDER#	MODEL#	SEER	NOM. TON.	LINESET	REQUIRED ACCESSORIES
OUTDOOR UNITS					
700817	CU-4E24RBU-5	22.0	2.0	--	--
INDOOR UNITS					
700815	CS-ME7RKUA	--	.58	1/4" x 3/8"	#19173 Yellow Jacket adapter
700812	CS-E9RKUAW	--	.75	1/4" x 3/8"	#19173 Yellow Jacket adapter
700813	CS-E12RKUAW	--	1.0	1/4" x 3/8"	(1) #19173 Yellow Jacket adapter + (1) #CZ-MA1P copper reducing fitting
700808	CS-E18RKUAW	--	1.5	1/4" x 3/8"	(1) #19173 Yellow Jacket adapter + (1) #CZ-MA1P copper reducing fitting
700809	CS-E24RKUAW	--	2.0	1/4" x 3/8"	(1) #19173 Yellow Jacket adapter + (1) #CZ-MA2P copper reducing fitting + (1) # CZ-MA3P copper reducing fitting

CU-4E24RBU-5 MULTI-ZONE OPERATION RANGE			
	Temperature	Indoor Air Intake Temp.	Outdoor Air Intake Temp.
Cooling	Maximum	90°F DB / 74°F WB	115°F DB / 79°F WB
	Minimum	61°F DB / 52°F WB	14°F DB / -°F WB
Heating	Maximum	86°F DB / -°F WB	75.2°F DB / 66.4°F WB
	Minimum	61°F DB / -°F WB	-5°F DB / -6.8°F WB

FOR SPECIFICATIONS, SEE PAGE 500.10

FOR ACCESSORIES, SEE PAGE 500.17

FOR ADDITIONAL INFORMATION, VISIT THE PANASONIC WEBSITE AT www.panasonic.com

PANASONIC

MULTI-ZONE SYSTEMS

(2 to 4 ZONES - 2 TON)

SPECIFICATIONS



2 to 4 ZONES (2 TON) OUTDOOR UNIT

Model No.	CU-4E24RBU-5		
Performance			
		Cooling	Heating
Capacity	Btu/h	24,000 (10,200-31,400)	37,800 (14,300-48,500)
Air Circulation	High CFM	1,963	2,330
Number of Connectable Indoor Units		2-4	2-4
SEER	Non-Ducted/Ducted	22.0 / 19.0	--
EER	Non-Ducted/Ducted	12.55 / 10.85	--
HSPF	Non-Ducted/Ducted	--	9.5 / 9.0
Electrical Rating			
Power Supply	V, Phase, Hz	230V/208V, 1PH, 60Hz	230V/208V, 1PH, 60Hz
Running Ampere	Non-Ducted/Ducted A	9.9-8.9 / 11.4-10.3	15.3-13.9 / 17.8-16.1
Power Input	W	1,910 (530-2,870)	3,030 (700-4,380)
Maximum Fuse Size	Amps	30	30
Features			
Controls		Microprocessor	Microprocessor
Fan Speeds		Variable Speed	Variable Speed
Compressor		Twin Rotary, DC Motor, Inverter	Twin Rotary, DC Motor, Inverter
Refrigerant / Amount Charged at Shipment		R-410A / 120.0 oz.	R-410A / 120.0 oz.
Refrigerant Control		Electric Expansion Valve	Electric Expansion Valve
Operation Sound Hi	dB-A	55	55
Refrigerant Tubing Connections	Type	Flare	Flare
Max. Allowable Tubing Length	Ft.	230 per system (82 per unit)	230 per system (82 per unit)
Refrigerant Discharge	inches	(4) 1/4	(4) 1/4
Tub Diameter Suction	inches	(4) 3/8	(4) 3/8
Required Adapter		(1) CZ-MA1P for indoor 12K & 18K Btu/hr units, (1) CZ-MA2P + (1) CZ-MA3P on 24K Btu/hr units	(1) CZ-MA1P for indoor 12K & 18K Btu/hr units, (1) CZ-MA2P + (1) CZ-MA3P on 24K Btu/hr units
Dimensions & Weight			
Unit Dimensions	H x W x D inches	39-11/32 x 37-1/32 x 13-13/32	39-11/32 x 37-1/32 x 13-13/32
Net Weight	lbs.	183	183

Important: You must use refrigerant piping rated for R410A. * Test conditions based on AHRI 210/240.

Panasonic 2018 Full Line Catalog

WALL MOUNT INDOOR UNITS

Model No.			CS-ME7RKUA	CS-E9RKUAW	CS-E12RKAUW	CS-E18RKUAW	CS-E24RKUAW
Performance & Electrical Ratings							
Capacity	Cooling	Btu/h	6,900 (6,100-9,900)	8,600 (6,100-9,000)	10,900 (6,100-13,000)	17,100 (6,500-19,800)	24,000 (5,800-27,200)
	Heating	Btu/h	10,900 (4,100-14,000)	12,300 (4,100-14,700)	15,300 (4,100-19,800)	23,400 (19,400-4,100)	28,800 (5,800-29,200)
Moisture Removal	High	Pints/H	0.8	1.1	1.3	3.0	7.6
Dry Air Flow	High	CFM	425	430	475	680	715
Power Supply	V, Phase, Hz		230V/208V, 1PH, 60Hz	230V/208V, 1PH, 60Hz	230V/208V, 1PH, 60Hz	230V/208V, 1PH, 60Hz	230V/208V, 1PH, 60Hz
Running Amps	Cooling	A	2.5 / 2.8	3.2 / 3.5	3.9 / 4.3	7.2 / 8.0	10.8 / 11.9
	Heating	A	3.7 / 4.1	4.7 / 5.2	6.0 / 6.6	8.3 / 9.3	11.4 / 12.6
Power Input	Cooling	W	500 (340-810)	630 (340-810)	800 (340-1,360)	1,300 (430-1,600)	2,350 (430-2,720)
	Heating	W	740 (300-1,230)	940 (300-1,230)	1,230 (200-2,100)	1,750 (380-1,800)	2,500 (380-2,660)
Operation Sound (Hi/Me/Lo/Q-Lo)	Cooling		39 / 25	40 / 25	43 / 28	47 / 39 / 36	48 / 40 / 37
	Heating		41 / 29	42 / 29	44 / 35 / 32	46 / 39 / 36	48 / 40 / 37
Refrigerant Tube Diameter	Discharge	inches	1/4	1/4	1/4	1/4	1/4
	Suction	inches	3/8	3/8	3/8	3/8	1/2
Required Adapters			none	none	CZ-MA1P	CZ-MA1P	CZ-MA2P and CZ-MA3P
Dimensions & Weight							
Height	inches		11-7/16	11-7/16	11-7/16	11-7/16	11-7/16
Width	inches		34-9/32	34-9/32	34-9/32	42-5/32	42-5/32
Depth	inches		8-7/16	8-7/16	8-7/16	9-15/32	9-15/32
Net Weight	lbs.		20	20	20	26	26

Important: You must use refrigerant piping rated for R410A. *This is maximum elevation difference when the indoor unit is located above the outdoor unit.

PANASONIC

MULTI-ZONE SYSTEMS

2 to 5 ZONES - 3 TON



- 2 to 5 zones
- 18.5 SEER
- Blue fin condenser
- DC twin rotary compressor
- Inverter technology
- Ductless zone control
- Electric expansion valve
- R-410A refrigerant

RESIDENTIAL WARRANTY

- 7 year compressor
- 30 days labor, compressor only
- 5 year parts other than compressor
- 1 year controller



CU-5E26QBU-5 OUTDOOR UNIT

RECOMMENDED ACCESSORY:
 #RSH-50 Surge Protector (required for Gold Level Contractor 12-year installations)

ID ORDER#	MODEL#	SEER	NOM. TON.	LINESET	REQUIRED ACCESSORIES
-----------	--------	------	-----------	---------	----------------------

OUTDOOR UNITS

684377	CU-5E36QBU-5	18.5	3.0	--	--
--------	--------------	------	-----	----	----

INDOOR UNITS

700815	CS-ME7RKUA	--	.58	1/4" x 3/8"	#19173 Yellow Jacket adapter
700812	CS-E9RKUAW	--	.75	1/4" x 3/8"	#19173 Yellow Jacket adapter
700813	CS-E12RKUAW	--	1.0	1/4" x 3/8"	(1) #19173 Yellow Jacket adapter + (1) #CZ-MA1P copper reducing fitting
700808	CS-E18RKUAW	--	1.5	1/4" x 3/8"	(1) #19173 Yellow Jacket adapter + (1) #CZ-MA1P copper reducing fitting
700809	CS-E24RKUAW	--	2.0	1/4" x 3/8"	(1) #19173 Yellow Jacket adapter + (1) #CZ-MA2P copper reducing fitting + (1) # CZ-MA3P copper reducing fitting

CU-5E36QBU-5 MULTI-ZONE OPERATION RANGE			
	Temperature	Indoor Air Intake Temp.	Outdoor Air Intake Temp.
Cooling	Maximum	90°F DB / 74°F WB	115°F DB / 79°F WB
	Minimum	61°F DB / 52°F WB	14°F DB / -°F WB
Heating	Maximum	86°F DB / -°F WB	75.2°F DB / 66.4°F WB
	Minimum	61°F DB / -°F WB	-5°F DB / -6.8°F WB

FOR SPECIFICATIONS, SEE PAGE 500.12

FOR ACCESSORIES, SEE PAGE 500.17

FOR ADDITIONAL INFORMATION, VISIT THE PANASONIC WEBSITE AT www.panasonic.com

PANASONIC

MULTI-ZONE SYSTEMS

(2 to 5 ZONES - 3 TON)

SPECIFICATIONS



2 to 5 ZONES (3 TON) OUTDOOR UNIT

Model No.		CU-5E36QBU-5	
Performance		Cooling	Heating
Capacity	Btu/h	36,000 (9,900-39,000)	37,800 (11,600-49,500)
Air Circulation	High CFM	2,475	2,475
Number of Connectable Indoor Units		2-5	2-5
SEER	Non-Ducted/Ducted	18.5 / 16.5	--
EER	Non-Ducted/Ducted	9.6 / 8.3	--
HSPF	Non-Ducted/Ducted	--	10.0 / 9.5
Electrical Rating			
Power Supply	V, Phase, Hz	230V/208V, 1PH, 60Hz	230V/208V, 1PH, 60Hz
Running Ampere	Non-Ducted/Ducted A	19.0-17.2 / 21.1-19.1	14.8-13.4 / 17.5-15.8
Power Input	W	3,750 (550-3,860)	2,900 (530-4,240)
Maximum Fuse Size	Amps	30	30
Features			
Controls		Microprocessor	Microprocessor
Fan Speeds		Variable Speed	Variable Speed
Compressor		Twin Rotary, DC Motor, Inverter	Twin Rotary, DC Motor, Inverter
Refrigerant / Amount Charged at Shipment		R-410A / 120.0 oz.	R-410A / 120.0 oz.
Refrigerant Control		Electric Expansion Valve	Electric Expansion Valve
Operation Sound	Hi dB-A	55	55
Refrigerant Tubing Connections		Type Flare	Type Flare
Max. Allowable Tubing Length		Ft. 262 per system (82 per unit)	Ft. 262 per system (82 per unit)
Refrigerant	Discharge inches	(5) 1/4	(5) 1/4
Tub Diameter	Suction inches	(5) 3/8	(5) 3/8
Required Adapter		(1) CZ-MA1P for indoor 12K & 18K Btu/hr units, (1) CZ-MA2P + (1) CZ-MA3P on 24K Btu/hr units	(1) CZ-MA1P for indoor 12K & 18K Btu/hr units, (1) CZ-MA2P + (1) CZ-MA3P on 24K Btu/hr units
Dimensions & Weight			
Unit Dimensions H x W x D		inches 39-11/32 x 37-1/32 x 13-13/32	inches 39-11/32 x 37-1/32 x 13-13/32
Net Weight		lbs. 183	lbs. 183

Important: You must use refrigerant piping rated for R410A. * Test conditions based on AHRI 210/240.

Panasonic 2018 Full Line Catalog

WALL MOUNT INDOOR UNITS

Model No.			CS-ME7RKUA	CS-E9RKUAW	CS-E12RKAUW	CS-E18RKUAW	CS-E24RKUAW
Performance & Electrical Ratings							
Capacity	Cooling	Btu/h	6,900 (6,100-9,900)	8,600 (6,100-9,000)	10,900 (6,100-13,000)	17,100 (6,500-19,800)	24,000 (5,800-27,200)
	Heating	Btu/h	10,900 (4,100-14,000)	12,300 (4,100-14,700)	15,300 (4,100-19,800)	23,400 (19,400-4,100)	28,800 (5,800-29,200)
Moisture Removal	High	Pints/H	0.8	1.1	1.3	3.0	7.6
Dry Air Flow	High	CFM	425	430	475	680	715
Power Supply	V, Phase, Hz		230V/208V, 1PH, 60Hz	230V/208V, 1PH, 60Hz	230V/208V, 1PH, 60Hz	230V/208V, 1PH, 60Hz	230V/208V, 1PH, 60Hz
Running Amps	Cooling	A	2.5 / 2.8	3.2 / 3.5	3.9 / 4.3	7.2 / 8.0	10.8 / 11.9
	Heating	A	3.7 / 4.1	4.7 / 5.2	6.0 / 6.6	8.3 / 9.3	11.4 / 12.6
Power Input	Cooling	W	500 (340-810)	630 (340-810)	800 (340-1,360)	1,300 (430-1,600)	2,350 (430-2,720)
	Heating	W	740 (300-1,230)	940 (300-1,230)	1,230 (200-2,100)	1,750 (380-1,800)	2,500 (380-2,660)
Operation Sound (Hi/Me/Lo/Q-Lo)	Cooling		39 / 25	40 / 25	43 / 28	47 / 39 / 36	48 / 40 / 37
	Heating		41 / 29	42 / 29	44 / 35 / 32	46 / 39 / 36	48 / 40 / 37
Refrigerant Tube Diameter	Discharge	inches	1/4	1/4	1/4	1/4	1/4
	Suction	inches	3/8	3/8	3/8	3/8	1/2
Required Adapters			none	none	CZ-MA1P	CZ-MA1P	CZ-MA2P and CZ-MA3P
Dimensions & Weight							
Height	inches		11-7/16	11-7/16	11-7/16	11-7/16	11-7/16
Width	inches		34-9/32	34-9/32	34-9/32	42-5/32	42-5/32
Depth	inches		8-7/16	8-7/16	8-7/16	9-15/32	9-15/32
Net Weight	lbs.		20	20	20	26	26

Important: You must use refrigerant piping rated for R410A. *This is maximum elevation difference when the indoor unit is located above the outdoor unit.

PANASONIC

MULTI-ZONE SYSTEMS

COMBINATION CHARTS



CU-2E18SBU-5
2 Zones
5 + 5
5 + 7
5 + 9
5 + 12
7 + 7
7 + 9
7 + 12
9 + 9
9 + 12
12 + 12

TOTAL SYSTEM CAPACITY INFORMATION

A first step in sizing and selecting any multi-zone system is to understand the **System Demand** that the building requires before selecting indoor unit combinations.

OUTDOOR UNIT CAPACITY

The **System Capacity** is the cooling and heating capacity listed at the top of each outdoor unit's specification chart.

INDOOR UNIT CAPACITY

The cooling and heating capacities are listed at the top of the specification chart of each Indoor Unit. The total of these partial indoor capacities is the **System Demand**.

DIVERSITY

Diversity is when the load in the conditioned space is not constant (i.e. the east side of a house has more direct sun and cooling load requirement in the morning and the west side has more direct sun and cooling load requirement in the afternoon). A system sizing calculation that plans for diversity may size up to approximately 130% of indoor unit demand vs. the outdoor unit's system capacity provided that planned operating demand throughout the day never exceeds 100% of system capacity. If there is no planned Diversity, then the indoor unit demand should not exceed 100% of the outdoor unit capacity.

CU-4E24RBU-5					
2 Zones	3 Zones		4 Zones		
5 + 18	5 + 5 + 5	7 + 7 + 12	5 + 5 + 5 + 5	5 + 7 + 7 + 24	7 + 7 + 9 + 24
5 + 24	5 + 5 + 7	7 + 7 + 18	5 + 5 + 5 + 7	5 + 7 + 9 + 9	7 + 7 + 12 + 12
7 + 9	5 + 5 + 9	7 + 7 + 24	5 + 5 + 5 + 9	5 + 7 + 9 + 12	7 + 7 + 12 + 18
7 + 12	5 + 5 + 12	7 + 9 + 9	5 + 5 + 5 + 12	5 + 7 + 9 + 18	7 + 9 + 9 + 9
7 + 18	5 + 5 + 18	7 + 9 + 12	5 + 5 + 5 + 18	5 + 7 + 9 + 24	7 + 9 + 9 + 12
7 + 24	5 + 5 + 24	7 + 9 + 18	5 + 5 + 5 + 24	5 + 7 + 12 + 12	7 + 9 + 9 + 18
9 + 9	5 + 7 + 7	7 + 9 + 24	5 + 5 + 7 + 7	5 + 7 + 12 + 18	7 + 9 + 12 + 12
9 + 12	5 + 7 + 9	7 + 12 + 12	5 + 5 + 7 + 9	5 + 7 + 18 + 18	7 + 9 + 12 + 18
9 + 18	5 + 7 + 12	7 + 12 + 18	5 + 5 + 7 + 12	5 + 9 + 9 + 9	7 + 12 + 12 + 12
9 + 24	5 + 7 + 18	7 + 12 + 24	5 + 5 + 7 + 18	5 + 9 + 9 + 12	7 + 12 + 12 + 18
12 + 12	5 + 7 + 24	7 + 18 + 18	5 + 5 + 7 + 24	5 + 9 + 9 + 18	9 + 9 + 9 + 9
12 + 18	5 + 9 + 9	9 + 9 + 9	5 + 5 + 9 + 9	5 + 9 + 9 + 24	9 + 9 + 9 + 12
12 + 24	5 + 9 + 12	9 + 9 + 12	5 + 5 + 9 + 12	5 + 9 + 12 + 12	9 + 9 + 9 + 18
18 + 18	5 + 9 + 18	9 + 9 + 18	5 + 5 + 9 + 18	5 + 9 + 12 + 18	9 + 9 + 12 + 12
18 + 24	5 + 9 + 24	9 + 9 + 24	5 + 5 + 9 + 24	5 + 12 + 12 + 12	9 + 9 + 12 + 18
--	5 + 12 + 12	9 + 12 + 12	5 + 5 + 12 + 12	5 + 12 + 12 + 18	9 + 12 + 12 + 12
--	5 + 12 + 18	9 + 12 + 18	5 + 5 + 12 + 18	7 + 7 + 7 + 7	12 + 12 + 12 + 12
--	5 + 12 + 24	9 + 12 + 24	5 + 5 + 12 + 24	7 + 7 + 7 + 9	--
--	5 + 18 + 18	9 + 18 + 18	5 + 5 + 18 + 18	7 + 7 + 7 + 12	--
--	5 + 18 + 24	12 + 12 + 12	5 + 7 + 7 + 7	7 + 7 + 7 + 18	--
--	7 + 7 + 7	12 + 12 + 18	5 + 7 + 7 + 9	7 + 7 + 7 + 24	--
--	7 + 7 + 9	12 + 12 + 24	5 + 7 + 7 + 12	7 + 7 + 9 + 9	--
--	--	12 + 18 + 18	5 + 7 + 7 + 18	7 + 7 + 9 + 12	--

PANASONIC MULTI-ZONE SYSTEMS COMBINATION CHARTS



CU-5E36QBU-5												
2 Zones	3 Zones			4 Zones			5 Zones					
	5+12	5+5+5	7+7+7	5+5+5+5	5+7+18+18	7+9+9+18	5+5+5+5+7	5+5+9+9+9	5+7+12+12+12	7+7+9+9+18		
5+18	5+5+7	7+7+9	5+5+5+7	5+7+18+24	7+9+9+24	5+5+5+5+9	5+5+9+9+12	5+7+12+12+18	7+7+9+9+24			
5+24	5+5+9	7+7+12	5+5+5+9	5+9+9+9	7+9+12+12	5+5+5+5+12	5+5+9+9+18	5+7+12+12+24	7+7+9+12+12			
7+9	5+5+12	7+7+18	5+5+5+12	5+9+9+12	7+9+12+18	5+5+5+5+18	5+5+9+9+24	5+7+12+18+18	7+7+9+12+18			
7+12	5+5+18	7+7+24	5+5+5+18	5+9+9+18	7+9+12+24	5+5+5+5+24	5+5+9+12+12	5+9+9+9+9	7+7+9+12+24			
7+18	5+5+24	7+9+9	5+5+5+24	5+9+9+24	7+9+18+18	5+5+5+7+7	5+5+9+12+18	5+9+9+9+12	7+7+9+18+18			
7+24	5+7+7	7+9+12	5+5+7+7	5+9+12+12	7+9+18+24	5+5+5+7+9	5+5+9+12+24	5+9+9+9+18	7+7+12+12+12			
9+9	5+7+9	7+9+18	5+5+7+9	5+9+12+18	7+12+12+12	5+5+5+7+12	5+5+9+18+18	5+9+9+9+24	8+7+12+12+18			
9+12	5+7+12	7+9+24	5+5+7+12	5+9+12+24	7+12+12+18	5+5+5+7+18	5+5+12+12+12	5+9+9+12+12	9+7+12+12+24			
9+18	5+7+18	7+12+12	5+5+7+18	5+9+18+18	7+12+12+24	5+5+5+7+24	5+5+12+12+18	5+9+9+12+18	7+7+12+18+18			
9+24	5+7+24	7+12+18	5+5+7+24	5+9+18+24	7+12+18+18	5+5+5+9+9	5+5+12+12+24	5+9+9+12+24	7+9+9+9+9			
12+12	5+9+9	7+12+24	5+5+9+9	5+12+12+12	7+12+18+24	5+5+5+9+12	5+5+12+18+18	5+9+9+18+18	8+9+9+9+12			
12+18	5+9+12	7+18+18	5+5+9+12	5+12+12+18	7+18+18+18	5+5+5+9+18	5+7+7+7+7	5+9+12+12+12	9+9+9+9+18			
12+24	5+9+18	7+18+24	5+5+9+18	5+12+12+24	9+9+9+9	5+5+5+9+24	5+7+7+7+9	5+9+12+12+18	10+9+9+9+24			
18+18	5+9+24	7+24+24	5+5+9+24	5+12+18+18	9+9+9+12	5+5+5+12+12	5+7+7+7+12	5+9+12+12+24	7+9+9+12+12			
18+24	5+12+12	9+9+9	5+5+12+12	5+12+18+24	9+9+9+18	5+5+5+12+18	5+7+7+7+18	5+9+12+18+18	7+9+9+12+18			
24+24	6+12+18	9+9+12	5+5+12+18	5+18+18+18	9+9+9+24	5+5+5+12+24	5+7+7+7+24	5+12+12+12+12	7+9+9+12+24			
--	7+12+24	9+9+18	5+5+12+24	7+7+7+7	9+9+12+12	5+5+5+18+18	5+7+7+9+9	5+12+12+12+18	7+9+9+18+18			
--	5+18+18	9+9+24	5+5+18+18	7+7+7+9	9+9+12+18	5+5+5+18+24	5+7+7+9+12	5+12+12+12+18	7+9+12+12+12			
--	5+18+24	9+12+12	5+5+18+24	7+7+7+12	9+9+12+24	5+5+7+7+7	5+7+7+9+18	7+7+7+7+7	7+9+12+12+18			
--	5+24+24	9+12+18	5+5+24+24	7+7+7+18	9+9+18+18	5+5+7+7+9	5+7+7+9+24	7+7+7+7+12	7+12+12+12+12			
--	--	9+12+24	5+7+7+7	7+7+7+24	9+9+18+24	5+5+7+7+12	5+7+7+12+12	7+7+7+7+18	7+12+12+12+18			
--	--	9+18+18	5+7+7+9	7+7+9+9	9+12+12+12	5+5+7+7+18	5+7+7+12+18	7+7+7+24	9+9+9+9+9			
--	--	9+18+24	5+7+7+12	7+7+9+12	9+12+12+18	5+5+7+7+24	5+7+7+12+24	7+7+7+9+9	9+9+9+9+12			
--	--	9+24+24	5+7+7+18	7+7+9+18	9+12+12+24	5+5+7+9+9	5+7+7+18+18	7+7+7+9+12	9+9+9+9+18			
--	--	12+12+12	5+7+7+24	7+7+9+24	9+12+18+18	5+5+7+9+12	5+7+7+9+18	7+7+7+9+18	9+9+9+9+24			
--	--	12+12+18	5+7+9+9	7+7+12+12	9+18+18+18	5+5+7+9+18	5+7+9+9+12	7+7+7+9+24	9+9+9+12+12			
--	--	12+12+24	5+7+9+12	7+7+12+18	12+12+12+12	5+5+7+9+24	5+7+9+9+18	7+7+7+12+12	9+9+9+12+18			
--	--	12+18+18	5+7+9+18	7+7+12+24	12+12+12+18	5+5+7+12+12	5+7+9+9+24	7+7+7+12+18	9+9+9+18+18			
--	--	12+18+24	5+7+9+24	7+7+18+18	12+12+12+24	5+5+7+12+18	5+7+9+12+18	7+7+7+12+24	9+9+12+12+12			
--	--	12+24+24	5+7+12+12	7+7+18+24	12+12+18+18	5+5+7+12+24	5+7+9+12+18	7+7+7+12+24	9+9+12+12+18			
--	--	18+18+18	5+7+12+18	7+9+9+9	7+9+9+9	5+5+7+18+18	5+7+9+12+24	7+7+9+9+9	9+12+12+12+12			
--	--	18+18+24	5+7+12+24	7+9+9+12	7+9+9+12	5+5+7+18+24	5+7+9+18+18	7+7+9+9+12	9+12+12+12+18			
--	--	--	--	--	--	--	--	--	--			
--	--	--	--	--	--	--	--	--	--			
--	--	--	--	--	--	--	--	--	--			
--	--	--	--	--	--	--	--	--	--			



MODEL IDENTIFICATION

Indoor Unit

Outdoor Unit

System

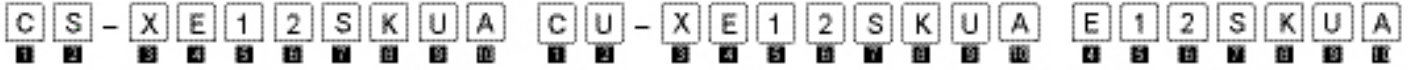

1	Series	2	Model Type	3	Connection Configuration	4	Function	5,6	Capacity	7	Development	8	Category (Type)	9	Voltage	10	Others
C	Residential	8	Indoor unit U: Outdoor unit	U: Deluxe type I: Home: Internal purpose MK: Indoor unit - Multi zone Connected Type (Multi-zone) Numerical Numerical+K	S: Cooling only E: Heat pump	Cooling Capacity in BTU/h	Development Series No.	K: Wall Mount B4: Mini Ceiling Recessed K: Internal	U: 209/230V, 60Hz	-1: Non-Low Ambient W: Multi/Single Zone common use -1: Non-Low Ambient							

PIPE LENGTHS, FITTINGS, ELEVATIONS AND REFRIGERANT

SYSTEM MODEL #	OD TUBE SIZE (In.)		MAX. LENGTH (Ft.) OF TUBING BETWEEN IN/OUTDOOR	MAX. ELEVATION DIFFERENCE (Ft.) BETWEEN IN/OUTDOOR		MAX. LENGTH (Ft.) WITHOUT ADDING REFRIGERANT (†)	REQUIRED ADD'L REFRIGERANT (Oz./Ft.)	INSULATION
	NARROW	WIDE		OUTDOOR ABOVE	OUTDOOR BELOW			
E9RKUA	1/4"	3/8"	66'	49'	49'	25'	R410A 0.2	Both Tubes
E12RKUA	1/4"	1/2"	66'	49'	49'	25'	R410A 0.2	Both Tubes
E18RKUA	1/4"	1/2"	100'	49'	49'	33'	R410A 0.3	Both Tubes
E24RKUA	1/4"	5/8"	100'	49'	49'	33'	R410A 0.3	Both Tubes
XE9WKUA	1/4"	3/8"	66'	49'	49'	25'	R410A 0.2	Both Tubes
XE12WKUA	1/4"	1/2"	66'	49'	49'	25'	R410A 0.2	Both Tubes
XE15WKUA	1/4"	1/2"	66'	49'	49'	25'	R410A 0.2	Both Tubes
XE18WKUA	1/4"	1/2"	100'	49'	49'	25'	R410A 0.3	Both Tubes
XE24WKUA	1/4"	5/8"	100'	49'	49'	25'	R410A 0.3	Both Tubes
XE9SKUA	1/4"	3/8"	66'	49'	49'	25'	R410A 0.2	Both Tubes
XE12SKUA-1	1/4"	1/2"	66'	49'	49'	25'	R410A 0.2	Both Tubes
XE15SKUA-1	1/4"	1/2"	66'	49'	49'	25'	R410A 0.3	Both Tubes
YE9WKU1	1/4"	3/8"	49'	TBD	TBD	25'	R410A 0.43	Both Tubes
YE12WKU1	1/4"	3/8"	49'	TBD	TBD	25'	R410A 0.43	Both Tubes
MULTI-SPLIT								
CU-2E18NBU-5	1/4"	3/8"	82'	49'	25'	66'	R410A 0.2	Both Tubes
CU-4E24NBU-5	1/4"	3/8"	82'	49'	25'	147'	R410A 0.2	Both Tubes
CU-5E36QBU-5	1/4"	3/8"	80'	49'	25'	150'	R410A 0.2	Both Tubes

Important: You must use refrigerant piping rated for R410A.

*Reducing adapter may be required depending on indoor model to be used with. (CZ-MA1P, CZ-MA2P or CZ-MA3P)

(†) Condenser is shipped with enough refrigerant to operate the system to this length. Additional refrigerant is required if this length is exceeded. See next column. This information is subject to change without notice. Please read the installation manual for proper procedures.



Single & Multi-Zone Wiring

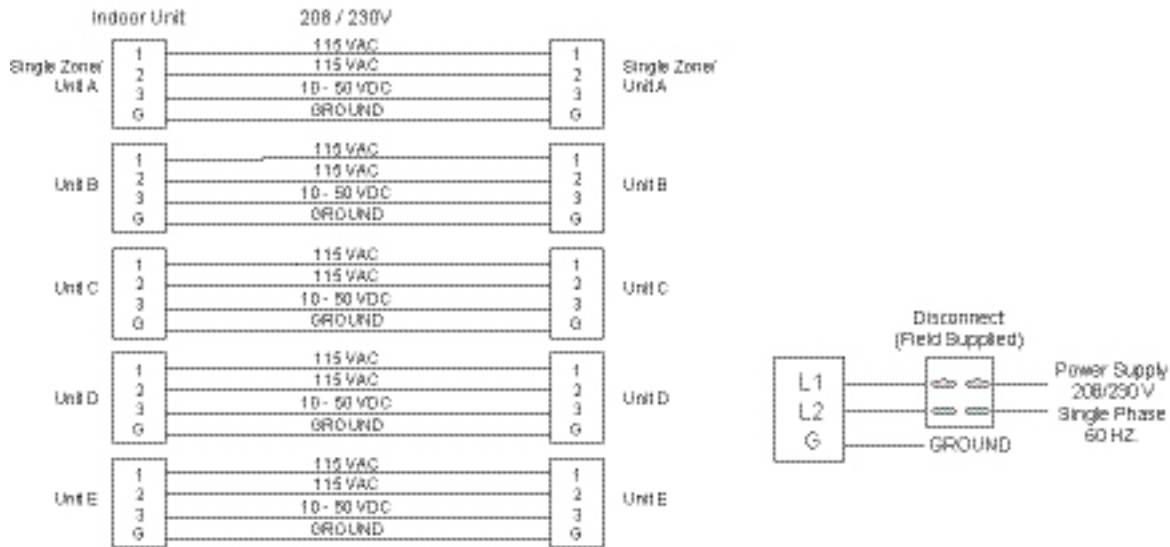

UL Listed or CSA approved 4 conductor wires minimum AWG16.
Wiring size may vary based on length and should be verified with a licensed electrician.

Supply power and inter-connecting wiring must be run separate conduits.

Panasonic 2018 Full Line Catalog

FOR ADDITIONAL INFORMATION, VISIT THE PANASONIC WEBSITE AT www.panasonic.com

SEPTEMBER 2024

Line #5200

PANASONIC ACCESSORIES

500.17



ID ORDER#	MODEL#	DESCRIPTION
692479	DSH-14-16V (Rectorseal #83020)	ADAPTER—PIPE , connects 1/2" ID drain hose to 3/4" PVC pipe
468310	19173 (Yellow Jacket)	ADAPTER—REFRIGERATION HOSE , 5/16" female flare x 1/4" male flare
54470	7-58P (Diversitech)	CLEAR VINYL TUBING , 5/8" ID x 100'
659622	CZ-MA1P (Mueller #A00481)	COPPER REDUCING FITTING , 1/2" female x 3/8" male
693917	CZ-MA2P (Mueller #A04888)	Same as above, but 3/8" female x 1/2" male
693916	CZ-MA3P (Mueller #A04770)	Same as above, 5/8" female x 1/2" male
747818	RSH-50 (Rectorseal #96415)	SURGE PROTECTOR PROTECTION DEVICE , 50kA, recommended accessory—required for Gold Level Contractor 12-year installations
711999	WBB-300 (Rectorseal #87733)	UNIVERSAL WALL CONDENSER BRACKET , 300 lb. limit (=Panasonic BS600)

FOR ADDITIONAL INFORMATION, VISIT THE PANASONIC WEBSITE AT www.panasonic.com

UNCASED RESIDENTIAL
13 SEER CA SERIES "A" COILS



- 13 SEER R-410A
- Upflow without field modification; downflow applications require the included plate kit
- Rifled copper tubing, enhanced aluminum fins
- Immersion-tested at 500 psi, then nitrogen-pressurized and sealed
- Left- or right-hand refrigerant and plumbing connections
- Externally mounted flowrater body with Schrader valve for hiss-testing
- Heavy duty plastic drain pan on most models (†)
- AHRI certifiable with all brands of A/C and heat pump systems
- ETL listed for use with both R-22 and R-410A when proper metering device is used

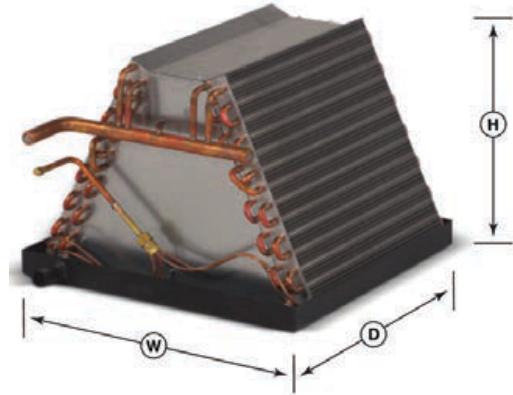

RESIDENTIAL WARRANTY - REGISTERED UNITS

- 10 year limited warranty from date of installation not to exceed 11 years from date of manufacture. **The unit must be properly registered with Aspen within 60 days after the original installation.**

RESIDENTIAL WARRANTY - NON-REGISTERED UNITS

- 5 year limited warranty from date of installation not to exceed 6 years from date of manufacture

ID ORDER#	MODEL#	SEER	NOM. TONS	PISTON SIZE (R-410A)	COIL W x D x H	REFRIGERANT CONNECTIONS	
						SUCTION	LIQUID
UNCASED VERTICAL "A" COIL — RESIDENTIAL							
642342	CA30A3G-160L-000	13	2.5	0.059	16" x 19-3/8" x 15-1/2"	3/4 OD	3/8 OD
642343	CA36A3G-160L-000	13	3.0	0.068	16" x 19-3/8" x 17-1/2"	3/4 OD	3/8 OD
745116	CA30A3G-195L-000	13	2.5	0.059	19-1/2" x 19-3/8" x 15-1/2"	3/4 OD	3/8 OD
742447	CA42A3G-195L-000	13	3.5	0.074	19-1/2" x 19-3/8" x 19-1/2"	7/8 OD	3/8 OD
747177	CA48A3G-195L-000	13	4.0	0.080	19-1/2" x 19-3/8" x 21-1/2"	7/8 OD	3/8 OD
672818	CA60A3G-195L-000	13	5.0	0.089	19-1/2" x 19-3/8" x 25-1/2"	7/8 OD	3/8 OD

R-22 ORIFICES (PISTONS) (††)

642355	3999	--	1.5	0.055	--	--	--
642356	4000	--	2.0	0.059	--	--	--
642357	3987	--	2.5	0.068	--	--	--
642358	4001	--	3.0	0.074	--	--	--
642361 (††)	3990	--	3.5	0.080	--	--	--
674434	3991	--	4.0	0.084	--	--	--
674435	3998	--	5.0	0.092	--	--	--

FOR ADDITIONAL INFORMATION, VISIT
THE ASPEN WEBSITE AT: www.aspenmfg.com

(†): Do not use heavy duty polypropylene drain pans on oil furnaces or other applications where outlet temperatures may exceed 290°F +/- 5°F.
(††): Also for 4.0T R-410A.

CASED RESIDENTIAL
13 SEER CE SERIES "A" COILS



- 13 SEER R-410A
- Multi-position—upflow, horizontal right or horizontal left without field modification; downflow applications require the included plate kit
- Riffled copper tubing, enhanced aluminum fins
- Immersion-tested at 500 psi, then nitrogen-pressurized and sealed
- Left- or right-hand refrigerant and plumbing connections
- Externally mounted flowrate body with Schrader valve for hiss-testing
- Heavy duty plastic upflow drain pans on most models; powder-coated galvanized steel horizontal drain pans standard on all (†)
- AHRI certifiable with all brands of A/C and heat pump systems
- ETL listed for use with both R-22 and R-410A when proper metering device is used

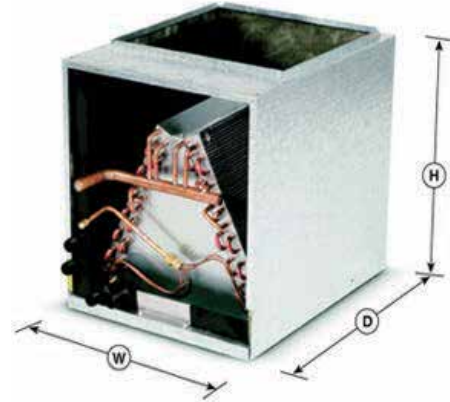

RESIDENTIAL WARRANTY - REGISTERED UNITS

- 10 year limited warranty from date of installation not to exceed 11 years from date of manufacture. **The unit must be properly registered with Aspen within 60 days after the original installation.**

RESIDENTIAL WARRANTY - NON-REGISTERED UNITS

- 5 year limited warranty from date of installation not to exceed 6 years from date of manufacture

ID ORDER#	MODEL#	SEER	NOM. TONS	PISTON SIZE (R-410A)	COIL W x D x H	REFRIGERANT CONNECTIONS	
						SUCTION	LIQUID
UNCASED VERTICAL "A" COIL — RESIDENTIAL						* = SPECIAL ORDER ITEM	
700854	CE24A2G-175L-111	13	1.5-2.0	0.055	17-1/2" x 21-1/2" x 19"	3/4 OD	3/8 OD
731910	CE30A4G-175L-111	13	2.5	0.059	17-1/2" x 21-1/2" x 19"	3/4 OD	3/8 OD
731912	CE36A3G-175L-111	13	3.0	0.068	17-1/2" x 21-1/2" x 23"	3/4 OD	3/8 OD
731913	CE42A3G-225L-111	13	3.0-3.5	0.074	22-1/2" x 21-1/2" x 23"	7/8 OD	3/8 OD
725519	CE48A3G-225L-111	13	4.0	0.080	22-1/2" x 21-1/2" x 27"	7/8 OD	3/8 OD
725520	CE60A3G-225L-111	13	5.0	0.089	22-1/2" x 21-1/2" x 30"	7/8 OD	3/8 OD

R-22 ORIFICES (PISTONS) (††)

642355	3999	--	1.5	0.055	--	--	--
642356	4000	--	2.0	0.059	--	--	--
642357	3987	--	2.5	0.068	--	--	--
642358	4001	--	3.0	0.074	--	--	--
642361 (††)	3990	--	3.5	0.080	--	--	--
674434	3991	--	4.0	0.084	--	--	--
674435	3998	--	5.0	0.092	--	--	--

FOR ADDITIONAL INFORMATION, VISIT
THE ASPEN WEBSITE AT: www.aspenmfg.com

(†): Do not use heavy duty polypropylene drain pans on oil furnaces or other applications where outlet temperatures may exceed 290°F +/- 5°F.
(††): Also for 4.0T R-410A.

UNCASED MANUFACTURED HOME
13 SEER CM SERIES "A" COILS



- 13 SEER R-410A
- Downflow plate kit included
- Rifled copper tubing, enhanced aluminum fins
- Immersion-tested at 500 psi, then nitrogen-pressurized and sealed
- Left-hand refrigerant and plumbing connections
- Liquid line Schrader valve for hiss-testing
- Heavy duty polypropylene drain pan (†)
- Drain connection: single left-hand 3/4" FPT
- Condensate drain elbow and flexible drain tubing included
- AHRI certifiable with all brands of A/C and heat pump systems
- ETL listed for use with both R-22 and R-410A when proper metering device is used



RESIDENTIAL WARRANTY - REGISTERED UNITS

- 10 year limited warranty from date of installation not to exceed 11 years from date of manufacture. **The unit must be properly registered with Aspen within 60 days after the original installation.**

RESIDENTIAL WARRANTY - NON-REGISTERED UNITS

- 5 year limited warranty from date of installation not to exceed 6 years from date of manufacture

ID ORDER#	MODEL#	SEER	NOM. TONS	PISTON SIZE (R-410A)	COIL W x D x H	REFRIGERANT CONNECTIONS	
						SUCTION	LIQUID
UNCASED VERTICAL "A" COIL — MANUFACTURED HOME							
642349	CM24A3G-177L-000	13	2.0	0.055	17-3/4" x 19-5/8" x 13-1/2"	3/4 OD	3/8 OD
642350	CM30A3G-177L-000	13	2.5	0.059	17-3/4" x 19-5/8" x 15-1/2"	3/4 OD	3/8 OD
642351	CM36A3G-177L-000	13	3.0	0.068	17-3/4" x 19-5/8" x 17-1/2"	3/4 OD	3/8 OD
642352	CM42A3G-177L-000	13	3.5	0.074	17-3/4" x 19-5/8" x 19-1/2"	7/8 OD	3/8 OD

R-22 ORIFICES (PISTONS) (††)

642355	3999	--	1.5	0.055	--	--	--
642356	4000	--	2.0	0.059	--	--	--
642357	3987	--	2.5	0.068	--	--	--
642358	4001	--	3.0	0.074	--	--	--
64236 (††)	3990	--	3.5	0.080	--	--	--
674434	3991	--	4.0	0.084	--	--	--
674435	3998	--	5.0	0.092	--	--	--

FOR ADDITIONAL INFORMATION, VISIT
THE ASPEN WEBSITE AT: www.aspenmfg.com

(†): Do not use heavy duty polypropylene drain pans on oil furnaces or other applications where outlet temperatures may exceed 290°F +/- 5°F.
(††): Also for 4.0T R-410A.

REZNOR

UDAP GAS-FIRED UNIT HEATERS



- Power vented
- 82-83% thermal efficient
- 50-60°F rise range
- Multi-try direct spark ignition with timed lockout
- Single-stage natural gas valve
- Tcore titanium stabilized aluminized steel heat exchanger
- External gas connection
- External terminal strip for 24V wiring
- Single-burner combustion system, including a one-piece burner assembly
- 115V, 1 phase, 60 Hz
- Transformer for 24V controls
- 115V open fan motor with internal overload protection
- Fan relay (included on the circuit board)
- Integrated circuit board with diagnostic indicator lights
- 2-point and 4-point suspension standard on all sizes
- Full fan guard
- Vibration/noise isolated fan and venter motors
- Sizes 30-400 certified for commercial/industrial heating applications; sizes 30-125 carry an additional approval for use in residential garage/workshop heating applications

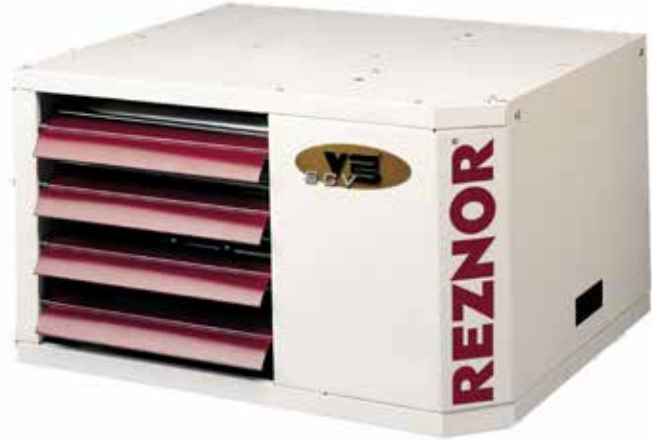

RESIDENTIAL WARRANTY
Original homeowner only.

- 10 year heat exchanger, 5 year parts

WHILE SUPPLIES LAST

ID ORDER#	MODEL #	FUEL	INPUT BTUH	OUTPUT BTUH	THROW @ 8' HT	CFM	VENT SIZE	DIMENSIONS H x W x L
208096	UDAP-250	NG	250,000	207,500	93'	3202	5"	26-1/8" x 38-3/16" x 42"

NOTE: A vent cap is required for all UDAP unit heaters. See page 503.8.

FOR ACCESSORIES, SEE PAGE 503.8
FOR UDAP LP CONVERSION KITS, CALL OUR OFFICE

FOR ADDITIONAL INFORMATION, VISIT THE REZNOR WEBSITE AT www.nortekhvac.com

REZNOR

UDAP GAS-FIRED UNIT HEATERS

SPECIFICATIONS



SIZE		30	45	60	75	100	125
Input Heating Capacity	BTUH	30,000	45,000	60,000	75,000	105,000	120,000
	kw/h	8.8	13.2	17.6	22.0	30.8	35.2
Thermal Efficiency (%)		82	83	83	83	83	83
Output Heating Capacity ^A	BTUH	24,600	37,350	49,800	62,250	87,150	99,600
	kw/h	7.2	11.0	14.6	18.3	25.6	29.2
Gas Connection (Inches) ^B	Natural	1/2	1/2	1/2	1/2	1/2	1/2
	Propane	1/2	1/2	1/2	1/2	1/2	1/2
Vent Connection Size ^C (in. diameter)		4	4	4	4	4	4
Control Amps (24V)		1.0	1.0	1.0	1.0	1.0	1.0
Full Load Amps (115V)		1.9	2.4	2.4	3.3	3.9	5.1
Max. Over Current Protection (115V) ^P		15	15	15	15	15	15
Normal Power Consumption (watts)		109	155	155	217	276	354
Discharge Air Temperature Rise (°F)		50	55	60	60	60	60
Air Volume	CFM	456	629	769	961	1345	1537
	M ³ /minute	12.9	17.8	21.8	27.5	36.7	45.9
Discharge Air Opening Area	ft ²	0.96	0.96	1.25	1.25	2.01	2.01
	M ²	0.09	0.09	0.12	0.12	0.19	0.19
Output Velocity	FPM	475	656	616	770	668	763
	M/minute	145	200	188	238	196	245
Fan Motor HP ^E	Open	0.02	0.03	0.03	0.06	1/30	1/20
	Enclosed	0.06	0.06	0.06	0.06	1/4	1/4
Fan Motor RPM		1550	1550	1550	1550	1050	1050
Fan Diameter (inches)		10	10	12	12	16	16
Sound Level	dba @ 15'	40	40	40	49	54	55
Approx Net Weight	lbs	54	59	67	72	96	101
Approximate Ship Weight	lbs	61	66	74	79	118	123

SIZE		150	175	200	225	250	300	350	400
Input Heating Capacity	BTUH	150,000	175,000	200,000	225,000	250,000	300,000	350,000	400,000
	kw/h	43.9	51.2	58.6	65.9	73.2	87.8	102.5	117.1
Thermal Efficiency (%)		83	83	83	83	83	83	83	83
Output Heating Capacity ^A	BTUH	124,500	145,250	166,000	186,750	207,500	249,000	290,500	332,000
	kw/h	36.4	42.5	48.6	54.7	60.8	72.9	85.1	97.2
Gas Connection (Inches) ^B	Natural	1/2	1/2	1/2	3/4	3/4	3/4	3/4	3/4
	Propane	1/2	1/2	1/2	3/4	3/4	3/4	3/4	3/4
Vent Connection Size ^C (in. diameter)		5	5	5	5	5	6	6	6
Control Amps (24V)		1.0	1.0	1.0	1.0	1.0	1.0	1.0	1.0
Full Load Amps (115V)		3.8	3.8	4.6	7.5	7.5	11.0	11.0	11.0
Max. Over Current Protection (115V) ^P		15	15	15	15	15	20	20	20
Normal Power Consumption (watts)		392	392	491	747	747	1086	1086	1086
Discharge Air Temperature Rise (°F)		60	60	60	60	60	60	60	60
Air Volume	CFM	1921	2242	2562	2882	3202	3843	4483	5123
	M ³ /minute	54.4	63.5	72.5	81.6	90.7	108.8	126.9	145.1
Discharge Air Opening Area	ft ²	2.56	2.56	2.56	3.51	3.51	4.79	4.79	4.79
	M ²	0.24	0.24	0.24	0.33	0.33	0.45	0.45	0.45
Output Velocity	FPM	752	877	1003	820	911	802	936	1069
	M/minute	229	267	306	250	278	244	285	326
Fan Motor HP ^E	Open	1/6	1/6	1/6	1/4	1/4	1/2	1/2	1/2
	Enclosed	1/4	1/4	1/4	1/4	1/4	1/2	1/2	1/2
Fan Motor RPM		1050	1050	1050	1050	1050	1050	1050	1050
Fan Diameter (inches)		18	18	18	20	20	24	24	24
Sound Level	dba @ 15'	51	52	53	56	56	59	61	62
Approx Net Weight	lbs	172	187	187	203	215	269	294	306
Approximate Ship Weight	lbs	204	219	219	245	257	321	346	358

^A CSA ratings for altitudes to 2000 feet.

^B Size shown is for gas connection to a single-stage gas valve, not supply line size.

^C Smaller and/or larger vent pipe diameters may be permissible; refer to the Venting Installation Manual for Power Vented Units.

^D MOPD - 2.25 x (largest motor FLA) + smallest motor FLA. Answer is rounded to the nearest commercially available circuit breaker.

^E All other information in this table is based on a heater equipped with a standard 115V open fan motor.

REZNOR

UDX GAS-FIRED UNIT HEATERS



- Power vented
- 82-83% thermal efficient
- 50-60°F rise range
- Multi-try direct spark ignition with timed lockout
- Single-stage natural gas valve
- Tcore titanium stabilized aluminized steel heat exchanger
- External gas connection
- External terminal strip for 24V wiring
- Single-burner combustion system, including a one-piece burner assembly
- 115V, 1 phase, 60 Hz
- Transformer for 24V controls
- 115V open fan motor with internal overload protection
- Fan relay (included on the circuit board)
- Integrated circuit board with 7-segment display for quick and easy diagnosis
- 2-point and 4-point suspension standard on all sizes
- Full fan guard
- Vibration/noise isolated fan and venter motors
- Sizes 30-400 certified for commercial/industrial heating applications; sizes 30-125 carry an additional approval for use in residential garage/workshop heating applications



RESIDENTIAL WARRANTY

Original homeowner only.

- 10 year heat exchanger, 5 year parts

ID ORDER#	MODEL #	FUEL	INPUT BTUH	OUTPUT BTUH	THROW @ 8' HT	CFM	VENT SIZE	DIMENSIONS H x W x L
751982	UDX-30	NG	30,000	24,600	26'	456	4"	13-3/4" x 27" x 25-9/16"
751985	UDX-45	NG	45,000	37,350	37'	629	4"	13-3/4" x 27" x 25-9/16"
751986	UDX-60	NG	60,000	49,800	42'	769	4"	16-3/4" x 27" x 25-9/16"
751987	UDX-75	NG	75,000	62,250	54'	961	4"	16-3/4" x 27" x 25-9/16"
751988	UDX-100	NG	105,000	87,150	56'	1345	4"	24-3/4" x 27" x 25-9/16"
751989	UDX-125	NG	120,000	99,600	63'	1537	4"	24-3/4" x 27" x 25-9/16"
751990	UDX-150	NG	150,000	124,500	73'	1921	5"	20-1/8" x 38-3/16" x 40"
751991 *	UDX-175	NG	175,000	145,250	90'	2242	5"	20-1/8" x 38-3/16" x 40"
751994	UDX-200	NG	200,000	166,000	93'	2562	5"	20-1/8" x 38-3/16" x 40"
751995 *	UDX-225	NG	225,000	186,750	86'	2882	5"	26-1/8" x 38-3/16" x 40"
751996	UDX-250	NG	250,000	207,500	93'	3202	5"	26-1/8" x 38-3/16" x 40"
751997 *	UDX-300	NG	300,000	249,000	94'	3843	6"	34-1/8" x 41" x 40"
751998 *	UDX-350	NG	350,000	290,500	105'	4483	6"	34-1/8" x 41" x 40"
751999 *	UDX-400	NG	400,000	332,000	113'	5123	6"	34-1/8" x 41" x 40"

* = SPECIAL ORDER ITEM

NOTE: A vent cap is required for all UDX unit heaters. See page 503.8.

UNIT HEATERS STOCKED IN NATURAL GAS ONLY. FOR LP CONVERSION KITS AND ACCESSORIES, SEE PAGE 503.8

FOR ADDITIONAL INFORMATION, VISIT THE REZNOR WEBSITE AT www.nortekhvac.com

REZNOR

UDX GAS-FIRED UNIT HEATERS

SPECIFICATIONS



SIZE		30	45	60	75	100	125
Input Heating Capacity	BTUH	30,000	45,000	60,000	75,000	105,000	120,000
	kw/h	8.8	13.2	17.6	22.0	30.8	35.2
Thermal Efficiency (%)		82	83	83	83	83	83
Output Heating Capacity ^A	BTUH	24,600	37,350	49,800	62,250	87,150	99,600
	kw/h	7.2	11.0	14.6	18.3	25.6	29.2
Gas Connection (Inches) ^B	Natural	1/2	1/2	1/2	1/2	1/2	1/2
	Propane	1/2	1/2	1/2	1/2	1/2	1/2
Vent Connection Size ^C (in. diameter)		4	4	4	4	4	4
Control Amps (24V)		1.0	1.0	1.0	1.0	1.0	1.0
Full Load Amps (115V)		1.9	2.4	2.4	3.3	3.9	5.1
Max. Over Current Protection (115V) ^P		15	15	15	15	15	15
Normal Power Consumption (watts)		109	155	155	217	276	354
Discharge Air Temperature Rise (°F)		50	55	60	60	60	60
Air Volume	CFM	456	629	769	961	1345	1537
	M ³ /minute	12.9	17.8	21.8	27.5	36.7	45.9
Discharge Air Opening Area	ft ²	0.96	0.96	1.25	1.25	2.01	2.01
	M ²	0.09	0.09	0.12	0.12	0.19	0.19
Output Velocity	FPM	475	656	616	770	668	763
	M/minute	145	200	188	238	196	245
Fan Motor HP ^E	Open	0.02	0.03	0.03	0.06	1/30	1/20
	Enclosed	0.06	0.06	0.06	0.06	1/4	1/4
Fan Motor RPM		1550	1550	1550	1550	1050	1050
Fan Diameter (inches)		10	10	12	12	16	16
Sound Level	dba @ 15'	40	40	40	49	54	55
Approx Net Weight	lbs	57	62	71	76	101	106
Approximate Ship Weight	lbs	63	68	76	81	120	125

SIZE		150	175	200	225	250	300	350	400
Input Heating Capacity	BTUH	150,000	175,000	200,000	225,000	250,000	300,000	350,000	400,000
	kw/h	43.9	51.2	58.6	65.9	73.2	87.8	102.5	117.1
Thermal Efficiency (%)		83	83	83	83	83	83	83	83
Output Heating Capacity ^A	BTUH	124,500	145,250	166,000	186,750	207,500	249,000	290,500	332,000
	kw/h	36.4	42.5	48.6	54.7	60.8	72.9	85.1	97.2
Gas Connection (Inches) ^B	Natural	1/2	1/2	1/2	3/4	3/4	3/4	3/4	3/4
	Propane	1/2	1/2	1/2	3/4	3/4	3/4	3/4	3/4
Vent Connection Size ^C (in. diameter)		5	5	5	5	5	6	6	6
Control Amps (24V)		1.0	1.0	1.0	1.0	1.0	1.0	1.0	1.0
Full Load Amps (115V)		3.8	3.8	4.6	7.5	7.5	11.0	11.0	11.0
Max. Over Current Protection (115V) ^P		15	15	15	15	15	20	20	20
Normal Power Consumption (watts)		392	392	491	747	747	1086	1086	1086
Discharge Air Temperature Rise (°F)		60	60	60	60	60	60	60	60
Air Volume	CFM	1921	2242	2562	2882	3202	3843	4483	5123
	M ³ /minute	54.4	63.5	72.5	81.6	90.7	108.8	126.9	145.1
Discharge Air Opening Area	ft ²	2.56	2.56	2.56	3.51	3.51	4.79	4.79	4.79
	M ²	0.24	0.24	0.24	0.33	0.33	0.45	0.45	0.45
Output Velocity	FPM	752	877	1003	820	911	802	936	1069
	M/minute	229	267	306	250	278	244	285	326
Fan Motor HP ^E	Open	1/6	1/6	1/6	1/4	1/4	1/2	1/2	1/2
	Enclosed	1/4	1/4	1/4	1/4	1/4	1/2	1/2	1/2
Fan Motor RPM		1050	1050	1050	1050	1050	1050	1050	1050
Fan Diameter (inches)		18	18	18	20	20	24	24	24
Sound Level	dba @ 15'	51	52	53	56	56	59	61	62
Approx Net Weight	lbs	178	193	193	221	223	277	303	316
Approximate Ship Weight	lbs	206	221	221	247	259	323	348	360

^A CSA ratings for altitudes to 2000 feet.

^B Size shown is for gas connection to a single-stage gas valve, not supply line size.

^C Smaller and/or larger vent pipe diameters may be permissible; refer to the Venting Installation Manual for Power Vented Units.

^D MOPD - 2.25 x (largest motor FLA) + smallest motor FLA. Answer is rounded to the nearest commercially available circuit breaker.

^E All other information in this table is based on a heater equipped with a standard 115V open fan motor.

SEPTEMBER 2024

Line #4990

REZNOR UDAS SEPARATED COMBUSTION GAS-FIRED UNIT HEATERS

503.4

REZNOR

- Power vented
- 82-83% thermal efficient
- 50-60°F rise range
- Multi-try direct spark ignition with timed lockout
- Single-stage natural gas valve
- Tcore titanium stabilized aluminized steel heat exchanger
- External gas connection
- External terminal strip for 24V wiring
- Single-burner combustion system, including a one-piece burner assembly
- 115V, 1 phase, 60 Hz supply voltage
- Transformer for 24V controls
- Fan relay (included on the circuit board)
- Integrated circuit board with diagnostic indicator lights
- 2-point and 4-point suspension standard on all sizes
- Full fan guard
- Vibration/noise isolated fan and venter motors
- 115V open fan motor with internal overload protection
- Sealed junction box for supply wiring
- Sealed control compartment
- Sizes 30-400 certified for commercial/industrial heating applications; sizes 30-125 carry an additional approval for use in residential garage/workshop heating applications



RESIDENTIAL WARRANTY

Original homeowner only.

- 10 year heat exchanger, 5 year parts

WHILE SUPPLIES LAST

ID ORDER#	MODEL #	FUEL	INPUT BTUH	OUTPUT BTUH	THROW @ 8' HT	CFM	VENT SIZE	DIMENSIONS H x W x L
207708	UDAS-125	NG	120,000	99,600	63'	1537	4"	23-1/8" x 26-5/8" x 29-3/8"

**FOR ACCESSORIES, SEE PAGE 503.8
FOR UDAS LP CONVERSION KITS, CALL OUR OFFICE**

**FOR ADDITIONAL INFORMATION, VISIT
THE REZNOR WEBSITE AT www.nortekhvac.com**

NOTE: MODEL UDAS UNITS REQUIRE SELECTION OF A COMBUSTION AIR INLET/VENT TERMINAL KIT. Kits are available for either a vertical through-the-roof system or a horizontal through-the-wall system. Each kit includes a concentric adapter box allowing for venting and inlet air with only one hole in the roof or wall, a vent terminal cap, and an inlet air cap or guard. Piping is field supplied **ADD EITHER VERTICAL OR HORIZONTAL INLET/VENT KIT TO THE BASE PRICE.**

REZNOR

UDAS GAS-FIRED UNIT HEATERS

SPECIFICATIONS



SIZE		30	45	60	75	100	125
Input Heating Capacity	BTUH	30,000	45,000	60,000	75,000	105,000	120,000
	kw/h	8.8	13.2	17.6	22.0	30.8	35.2
Thermal Efficiency (%)		82	83	83	83	83	83
Output Heating Capacity ^A	BTUH	24,600	37,350	49,800	62,250	87,150	99,600
	kw/h	7.2	10.9	14.6	18.2	25.5	29.2
Gas Connection (Inches) ^B	Natural	1/2	1/2	1/2	1/2	1/2	1/2
	Propane	1/2	1/2	1/2	1/2	1/2	1/2
Vent Connection Size ^C (in. diameter)		4	4	4	4	4	4
Combustion Air Inlet ^C (in. diameter)		4	4	4	4	4	4
Control Amps (24V)		1.0	1.0	1.0	1.0	1.0	1.0
Full Load Amps (115V)		1.9	2.4	2.4	3.3	3.9	5.1
Max. Over Current Protection (115V) ^D		15	15	15	15	15	15
Normal Power Consumption (watts)		109	155	155	217	276	354
Discharge Air Temperature Rise (°F)		50	55	60	60	60	60
Air Volume	CFM	456	629	769	961	1345	1537
	M ³ /minute	12.9	17.8	21.8	27.2	38.1	43.5
Discharge Air Opening Area	ft ²	0.96	0.96	1.25	1.25	2.01	2.01
	M ²	0.09	0.09	0.12	0.12	0.19	0.19
Output Velocity	FPM	475	656	616	770	668	763
	M/minute	145	200	188	235	204	233
Fan Motor HP ^E	Open	0.02	0.03	0.03	0.06	1/30	1/20
	Enclosed	0.06	0.06	0.06	0.06	1/4	1/4
Fan Motor RPM		1550	1550	1550	1550	1050	1050
Fan Diameter (inches)		10	10	12	12	16	16
Sound Level	dba @ 15'	40	40	40	49	54	55
Approx Net Weight	lbs	55	60	68	73	97	102
Approximate Ship Weight	lbs	63	68	76	81	120	125

SIZE		150	175	200	225	250	300	350	400
Input Heating Capacity	BTUH	150,000	175,000	200,000	225,000	250,000	300,000	350,000	400,000
	kw/h	44.0	51.3	58.6	65.9	73.3	87.9	102.6	117.2
Thermal Efficiency (%)		83	83	83	83	83	83	83	83
Output Heating Capacity ^A	BTUH	124,500	145,250	166,000	186,750	207,500	249,000	290,500	332,000
	kw/h	36.5	42.6	48.7	54.7	60.8	73.0	85.1	97.3
Gas Connection (Inches) ^B	Natural	1/2	1/2	1/2	3/4	3/4	3/4	3/4	3/4
	Propane	1/2	1/2	1/2	3/4	3/4	3/4	3/4	3/4
Vent Connection Size ^C (in. diameter)		5	5	5	5	5	6	6	6
Combustion Air Inlet ^C (in. diameter)		6	6	6	6	6	6	6	6
Control Amps (24V)		1.0	1.0	1.0	1.0	1.0	1.0	1.0	1.0
Full Load Amps (115V)		3.8	3.8	4.6	7.5	7.5	11.0	11.0	11.0
Max. Over Current Protection (115V) ^D		15	15	15	15	15	20	20	20
Normal Power Consumption (watts)		392	392	491	747	747	1086	1086	1086
Discharge Air Temperature Rise (°F)		60	60	60	60	60	60	60	60
Air Volume	CFM	1921	2242	2562	2882	3202	3843	4483	5123
	M ³ /minute	54.4	63.5	72.5	81.6	90.7	108.8	126.9	145.1
Discharge Air Opening Area	ft ²	2.56	2.56	2.56	3.51	3.51	4.79	4.79	4.79
	M ²	0.24	0.24	0.24	0.33	0.33	0.45	0.45	0.45
Output Velocity	FPM	752	877	1003	820	911	802	936	1069
	M/minute	229	267	306	250	278	244	285	326
Fan Motor HP ^E	Open	1/6	1/6	1/6	1/4	1/4	1/2	1/2	1/2
	Enclosed	1/4	1/4	1/4	1/4	1/4	1/2	1/2	1/2
Fan Motor RPM		1050	1050	1050	1050	1050	1050	1050	1050
Fan Diameter (inches)		18	18	18	20	20	24	24	24
Sound Level	dba @ 15'	51	52	53	56	56	59	61	62
Approx Net Weight	lbs	173	188	188	204	216	270	295	307
Approximate Ship Weight	lbs	206	221	221	247	259	323	348	360

^A CSA ratings for altitudes to 2000 feet.

^B Size shown is for gas connection to a single-stage gas valve, not supply line size.

^C Smaller and/or larger vent pipe diameters may be permissible; refer to the Venting Installation Manual for Power Vented Units.

^D MOPD - 2.25 x (largest motor FLA) + smallest motor FLA. Answer is rounded to the nearest commercially available circuit breaker.

^E All other information in this table is based on a heater equipped with a standard 115V open fan motor.

REZNOR

UDZ SEPARATED COMBUSTION GAS-FIRED UNIT HEATERS



- Power vented
- 82-83% thermal efficient
- 50-60°F rise range
- Multi-try direct spark ignition with timed lockout
- Single-stage natural gas valve
- Tcore titanium stabilized aluminized steel heat exchanger
- External gas connection
- External terminal strip for 24V wiring
- Single-burner combustion system, including a one-piece burner assembly
- 115V, 1 phase, 60 Hz
- Transformer for 24V controls
- Fan relay (included on the circuit board)
- Integrated circuit board with 7-segment display for quick and easy diagnosis
- 2-point and 4-point suspension standard on all sizes
- Full fan guard
- Vibration/noise isolated fan and venter motors
- 115V open fan motor with internal overload protection
- Sealed junction box for supply wiring
- Sealed control compartment
- Sizes 30-400 certified for commercial/industrial heating applications; sizes 30-125 carry an additional approval for use in residential garage/workshop heating applications



RESIDENTIAL WARRANTY

Original homeowner only.

- 10 year heat exchanger, 5 year parts

ID ORDER#	MODEL #	FUEL	INPUT BTUH	OUTPUT BTUH	THROW @ 8' HT	CFM	VENT SIZE	DIMENSIONS H x W x L
752023 *	UDZ-30	NG	30,000	24,600	26'	456	4"	13-3/4" x 27" x 25-9/16"
752024	UDZ-45	NG	45,000	37,350	37'	629	4"	13-3/4" x 27" x 25-9/16"
752025 *	UDZ-60	NG	60,000	49,800	42'	769	4"	16-3/4" x 27" x 25-9/16"
752026	UDZ-75	NG	75,000	62,250	54'	961	4"	16-3/4" x 27" x 25-9/16"
752027 *	UDZ-100	NG	105,000	87,150	56'	1345	4"	24-3/4" x 27" x 25-9/16"
752028	UDZ-125	NG	120,000	99,600	63'	1537	4"	24-3/4" x 27" x 25-9/16"
752029 *	UDZ-150	NG	150,000	124,500	73'	1921	5"	20-1/8" x 38-3/16" x 40"
752030 *	UDZ-175	NG	175,000	145,250	90'	2242	5"	20-1/8" x 38-3/16" x 40"
752031 *	UDZ-200	NG	200,000	166,000	93'	2562	5"	20-1/8" x 38-3/16" x 40"
752032 *	UDZ-225	NG	225,000	186,750	86'	2882	5"	26-1/8" x 38-3/16" x 40"
752033 *	UDZ-250	NG	250,000	207,500	93'	3202	5"	26-1/8" x 38-3/16" x 40"
752034 *	UDZ-300	NG	300,000	249,000	94'	3843	6"	34-1/8" x 41" x 40"
752035 *	UDZ-350	NG	350,000	290,500	105'	4483	6"	34-1/8" x 41" x 40"
752036 *	UDZ-400	NG	400,000	332,000	113'	5123	6"	34-1/8" x 41" x 40"

* = SPECIAL ORDER ITEM

FOR LP CONVERSION KITS AND ACCESSORIES, SEE PAGE 503.8

FOR ADDITIONAL INFORMATION, VISIT THE REZNOR WEBSITE AT www.nortekhvac.com

NOTE: MODEL UDZ UNITS REQUIRE SELECTION OF A COMBUSTION AIR INLET/VENT TERMINAL KIT. Kits are available for either a vertical through-the-roof system or a horizontal through-the-wall system. Each kit includes a concentric adapter box allowing for venting and inlet air with only one hole in the roof or wall, a vent terminal cap, and an inlet air cap or guard. Piping is field supplied **ADD EITHER VERTICAL OR HORIZONTAL INLET/VENT KIT TO THE BASE PRICE.**

REZNOR

UDZ GAS-FIRED UNIT HEATERS

SPECIFICATIONS



SIZE		30	45	60	75	100	125
Input Heating Capacity	BTUH	30,000	45,000	60,000	75,000	105,000	120,000
	kw/h	8.8	13.2	17.6	22.0	30.8	35.2
Thermal Efficiency (%)		82	83	83	83	83	83
Output Heating Capacity ^A	BTUH	24,600	37,350	49,800	62,250	87,150	99,600
	kw/h	7.2	10.9	14.6	18.2	25.5	29.2
Gas Connection (Inches) ^B	Natural	1/2	1/2	1/2	1/2	1/2	1/2
	Propane	1/2	1/2	1/2	1/2	1/2	1/2
Vent Connection Size ^C (in. diameter)		4	4	4	4	4	4
Combustion Air Inlet ^C (in. diameter)		4	4	4	4	4	4
Control Amps (24V)		1.0	1.0	1.0	1.0	1.0	1.0
Full Load Amps (115V)		1.9	2.4	2.4	3.3	3.9	5.1
Max. Over Current Protection (115V) ^P		15	15	15	15	15	15
Normal Power Consumption (watts)		109	155	155	217	276	354
Discharge Air Temperature Rise (°F)		50	55	60	60	60	60
Air Volume	CFM	456	629	769	961	1345	1537
	M ³ /minute	12.9	17.8	21.8	27.2	38.1	43.5
Discharge Air Opening Area	ft ²	0.96	0.96	1.25	1.25	2.01	2.01
	M ²	0.09	0.09	0.12	0.12	0.19	0.19
Output Velocity	FPM	475	656	616	770	668	763
	M/minute	145	200	188	235	204	233
Fan Motor HP ^E	Open	0.02	0.03	0.03	0.06	1/30	1/20
	Enclosed	0.06	0.06	0.06	0.06	1/4	1/4
Fan Motor RPM		1550	1550	1550	1550	1050	1050
Fan Diameter (inches)		10	10	12	12	16	16
Sound Level	dba @ 15'	40	40	40	49	54	55
Approx Net Weight	lbs	58	63	71	77	102	107
Approximate Ship Weight	lbs	66	71	79	85	125	130

SIZE		150	175	200	225	250	300	350	400
Input Heating Capacity	BTUH	150,000	175,000	200,000	225,000	250,000	300,000	350,000	400,000
	kw/h	44.0	51.3	58.6	65.9	73.3	87.9	102.6	117.2
Thermal Efficiency (%)		83	83	83	83	83	83	83	83
Output Heating Capacity ^A	BTUH	124,500	145,250	166,000	186,750	207,500	249,000	290,500	332,000
	kw/h	36.5	42.6	48.7	54.7	60.8	73.0	85.1	97.3
Gas Connection (Inches) ^B	Natural	1/2	1/2	1/2	3/4	3/4	3/4	3/4	3/4
	Propane	1/2	1/2	1/2	3/4	3/4	3/4	3/4	3/4
Vent Connection Size ^C (in. diameter)		5	5	5	5	5	6	6	6
Combustion Air Inlet ^C (in. diameter)		6	6	6	6	6	6	6	6
Control Amps (24V)		1.0	1.0	1.0	1.0	1.0	1.0	1.0	1.0
Full Load Amps (115V)		3.8	3.8	4.6	7.5	7.5	11.0	11.0	11.0
Max. Over Current Protection (115V) ^P		15	15	15	15	15	20	20	20
Normal Power Consumption (watts)		392	392	491	747	747	1086	1086	1086
Discharge Air Temperature Rise (°F)		60	60	60	60	60	60	60	60
Air Volume	CFM	1921	2242	2562	2882	3202	3843	4483	5123
	M ³ /minute	54.4	63.5	72.5	81.6	90.7	108.8	126.9	145.1
Discharge Air Opening Area	ft ²	2.56	2.56	2.56	3.51	3.51	4.79	4.79	4.79
	M ²	0.24	0.24	0.24	0.33	0.33	0.45	0.45	0.45
Output Velocity	FPM	752	877	1003	820	911	802	936	1069
	M/minute	229	267	306	250	278	244	285	326
Fan Motor HP ^E	Open	1/6	1/6	1/6	1/4	1/4	1/2	1/2	1/2
	Enclosed	1/4	1/4	1/4	1/4	1/4	1/2	1/2	1/2
Fan Motor RPM		1050	1050	1050	1050	1050	1050	1050	1050
Fan Diameter (inches)		18	18	18	20	20	24	24	24
Sound Level	dba @ 15'	51	52	53	56	56	59	61	62
Approx Net Weight	lbs	179	194	194	212	224	278	304	317
Approximate Ship Weight	lbs	212	227	227	255	267	331	357	370

^A CSA ratings for altitudes to 2000 feet.

^B Size shown is for gas connection to a single-stage gas valve, not supply line size.

^C Smaller and/or larger vent pipe diameters may be permissible; refer to the Venting Installation Manual for Power Vented Units.

^D MOPD - 2.25 x (largest motor FLA) + smallest motor FLA. Answer is rounded to the nearest commercially available circuit breaker.

^E All other information in this table is based on a heater equipped with a standard 115V open fan motor.

SEPTEMBER 2024

Line #4990/#4991

REZNOR

GAS-FIRED UNIT HEATER ACCESSORIES

503.8



ID ORDER#	MODEL #	DESCRIPTION
--------------	---------	-------------

VENT CAPS FOR UDAP & UDX UNIT HEATERS (REQUIRED)

* = SPECIAL ORDER ITEM

50550	111848	CC1 VENT CAP , 4" for UDAP/UDX-30 through UDAP/UDX-125
50551	111849	<i>Same as above</i> , but 5" and for UDAP/UDX-150 through UDAP/UDX-250
50667 *	111850	<i>Same as above</i> , but 6" and for UDAP/UDX-300 and UDAP/UDX-400

INLET KITS FOR UDAS & UDZ UNIT HEATERS (REQUIRED)

209903	205895	CC2 VERTICAL INLET KIT , for UDAS/UDZ-30 through UDAS/UDZ-125 units
215730 *	205896	<i>Same as above</i> , but for UDAS/UDZ-150 through UDAS/UDZ-400 units
209905	211762	CC6 HORIZONTAL INLET KIT , for UDAS/UDZ-30 through UDAS/UDZ-125 units
215728 *	211763	<i>Same as above</i> , but for UDAS/UDZ-150 through UDAS/UDZ-400 units

VENTING KITS

697801	--	HORIZONTAL VENTING KIT , for UDAP/UDX-30 through UDAP/UDX-60 units (residential application only); includes (1) 4" stainless steel appliance starter, (1) 4"x3" stainless steel reducer, (1) 3" stainless steel square thimble, (1) 3" vent cap, and (1) 3" male adapter; add for pipe
699475	--	VERTICAL VENTING KIT , for UDAP/UDX-30 through UDAP/UDX-60 units (residential application only); includes (1) 4" stainless steel appliance starter, (1) 4"x3" stainless steel reducer, (1) 3" stainless steel horizontal/vertical support, (1) 3" storm collar, (1) 3" vent cap, and (1) 3" male adapter; add for pipe and roof flashing

LP CONVERSION KITS

756490	1036536R	NATURAL TO LP GAS CONVERSION KIT , for UDX-30, UDZ-30, UDX-45 and UDZ-45 units
756492	1036537R	<i>Same as above</i> , but for UDX-60, UDZ-60, UDX-75 and UDZ-75 units
756489	1036538R	<i>Same as above</i> , but for UDX-100, UDZ-100, UDX-125 and UDZ-125 units
756493	1036539R	<i>Same as above</i> , but for UDX-150, UDZ-150, UDX-175 and UDZ-175 units
756495	1036540R	<i>Same as above</i> , but for UDX-200, UDZ-200, UDX-225, UDZ-225, UDX-250 and UDZ-250 units
756496	1036541R	<i>Same as above</i> , but for UDX-300, UDZ-300, UDX-350, UDZ-350, UDX-400 and UDZ-400 units

CEILING HANGER KIT

197379	197094	CK-22 CEILING HANGER (SUSPENSION) KIT , 4-point, for UDAP/UDX-30 and UDAS/UDZ-30 through UDAP/UDX-125 and UDAS/UDZ-125 units; excludes rods
--------	--------	--

FOR UDAP & UDAS LP CONVERSION KITS, CALL OUR OFFICE

**FOR ADDITIONAL INFORMATION, VISIT
THE REZNOR WEBSITE AT www.nortekvac.com**

MILLER

CMF POWER OIL FURNACES

80+ EFFICIENCY



- CMF3 units are FER compliant
- 3-speed custom fit blower
- Multi-firing technology in gas and oil burner
- Drum/tubular heat exchanger
- Resized auxiliary limit switch
- 115V, 60Hz, 1-phase
- 1/2" NPT gas connections
- 24V, 60 Hz, 15VAC thermostat circuit (add for thermostat)
- Beckett oil burner
- Classic 18" width dimension for tight replacement jobs
- MA 100, MA 200 and CB 200 bases for versatility in applications

RESIDENTIAL WARRANTY

Effective on product manufactured after 4-1-19. Original homeowner only.

- 1 year parts, 20 year heat exchanger, 1 year labor

For Contractors' Preferred Protection Plans, contact your R. A. Townsend Co. representative.



CMF2



CMF3

ID ORDER#	MODEL#	MILLER#	AFUE	INPUT BTUH	HEATING OUTPUT BTUH	VENT SIZE	DIMENSIONS (W x D x H)
CMF2 POWER OIL							
556357	CMF2-80-PO2	1041043	80+	75,000	60,000	4"	18" x 24-1/4" x 57"
CMF3 POWER GAS (FER Compliant)							
741203 *	CMF3-70T-PGP	1027042P	80+	70,000	56,000	4"	18" x 24-1/4" x 57"

FOR CMF ACCESSORIES, SEE PAGE 504.1
FOR ADDITIONAL INFORMATION, VISIT
THE NORTEK WEBSITE AT www.nortekhvac.com

NOTE: Floor bases are not included. The CMF2 model will fit the MGC, MOC, and AGC older bases, so it is not necessary to change out the old base to accommodate a new furnace. When changing out an old MMG furnace or when replacing another manufacturer's furnace with a CMF2 model, you must change to a MA-200 base.

MILLER

CMF POWER OIL FURNACES

ACCESSORIES

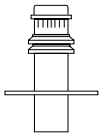

ID ORDER#	MODEL#	MILLER#	DESCRIPTION	
624834	--	921066	CHIMNEY-FRIENDLY VENT KIT , tile-lined masonry	
125281	--	903102	CMF-80POP TO CMF-100POP CONVERSION KIT , to convert from 75,000 to 90,000 BTUH	
34252	CB-200A	901696	COTTAGE BASE , UL approved	
	9381	SRJ-1	104060000	ROOF JACK ASSEMBLY , 12" x 4"
	9382	SRJ-2	104060003	Same as above, but 24" x 4"
	9383	SRJ-3	104060015	Same as above, but 36" x 4"
	9384	SRJ-4	104060018	Same as above, but 48" x 4"
202485	--	903893	ROOF JACK ADAPTER , (roof wedge), 2.5/12 pitch, 21"W x 30"D, for CMF and MI series	
202486	--	903894	Same as above, but 3.0/12 pitch and 21"W x 30-3/4"D	
202487	--	903895	Same as above, but 4.0/12 pitch and 21"W x 31-1/2"D	
9335	MA-200	903453	UNIVERSAL BASE , for mobile home, 18"W x 24"D overall dimension, 12"W x 12"D opening with 8" duct connector	
236367	--	904106	VENT CONVERSION KIT , converts roofjacks to accept (2) 2" PVC pipes for high efficiency furnace installations	
9378	--	103947002	VENT PACKAGE , 28"	
9379	--	103947004	Same as above, but 34"	
9380	--	103947005	Same as above, but 40"	

FOR ADDITIONAL INFORMATION, VISIT
THE NORTEK WEBSITE AT www.nortekhvac.com

MILLER

MG2R GAS FURNACES

95% - SINGLE STAGE



- FER compliant, single stage
- Multi-speed ECM blower (includes 40V transformer)
- 100% fired and tested
- Sealed combustion approved for direct vent furnace, category IV venting system - can be vertically or horizontally vented using a 2-pipe system for maximum flexibility in installation
- Natural gas with LP conversion kit
- Hot surface ignitor with Smartlite technology
- Tubular primary heat exchanger
- Stainless steel secondary heat exchanger
- Fixed 30-second blower delay
- Fixed 30-second post purge
- 60-second fixed cooling cycle blower-off delay (TDR)
- Easy troubleshooting diagnostic lights
- 3 amp fuse protection against low voltage shorts
- Low voltage terminal board
- Color-coded wire harness
- Add for thermostat



PLEASE NOTE:

MG2R furnaces are not approved for residential or modular home applications — only for manufactured housing.

RESIDENTIAL REGISTERED WARRANTY

Effective on product manufactured after 4-1-19. Original homeowner only. Product must be registered within 60 days of installation date. (†)

- 5 year parts, 20 year heat exchanger, 1 year labor

RESIDENTIAL NON-REGISTERED WARRANTY

Effective on product manufactured after 4-1-19. Original homeowner only.

- 1 year parts, 20 year heat exchanger, 1 year labor

For Contractors' Preferred Protection Plans, contact your R. A. Townsend Co. representative.

(†) IMPORTANT WARRANTY NOTE:

In order to be eligible for the full registered warranty and Quality Pledge, the consumer or Nortek dealer must register within 60 days of the later date of either installation or occupancy. If registration is not completed within 60 days, the warranty reverts to the non-registered (base standard) warranty.

The warranty registration form must be completed online at www.nortekvacwarranty.com/index.aspx. For registration assistance, please call 866-319-9592.

ID ORDER#	MODEL#	MBH CAPACITY		AFUE	VENT SIZE	DIMENSIONS W x D x H
		IN	OUT			
741177	MG2R-045F1AAM2	45,000	42,750	95.0	2" or 3"	19-7/8" x 24-5/8" x 56"
741178	MG2R-060F1AAM2	60,000	57,000	95.0	2" or 3"	19-7/8" x 24-5/8" x 56"
741179	MG2R-072F1AAM2	72,000	68,400	95.0	2" or 3"	19-7/8" x 24-5/8" x 56"

FOR SPECIFICATIONS & BLOWER PERFORMANCE, SEE PAGES 504.3-504.4

FOR ACCESSORIES, SEE PAGES 504.12-504.13

FOR AIR CONDITIONING COILS, SEE PAGE 504.16

MAXIMUM DIRECT VENT, DUAL PIPE LENGTH (FT.)		
MG2R INPUTS (BTU)	INLET/OUTLET 2" DIAMETER	INLET/OUTLET 3" DIAMETER
45,000	30	60
60,000	30	60
72,000	30	60

MAXIMUM DIRECT VENT NOTES:

1. Subtract 2.5 ft. for each additional 2" long radius elbow; subtract 5 ft. for each additional 2" short radius elbow; subtract 3.5 ft. for each additional 3" long radius elbow; and subtract 7 ft. for each additional 3" short radius elbow.
2. Two 45° elbows are equivalent to one 90° elbow.
3. This table applies to elevations from sea level to 2,000 ft. For higher elevations, decrease pipe lengths by 8% per 1,000 ft. of altitude.

MILLER

MG2R GAS FURNACES

SPECIFICATIONS

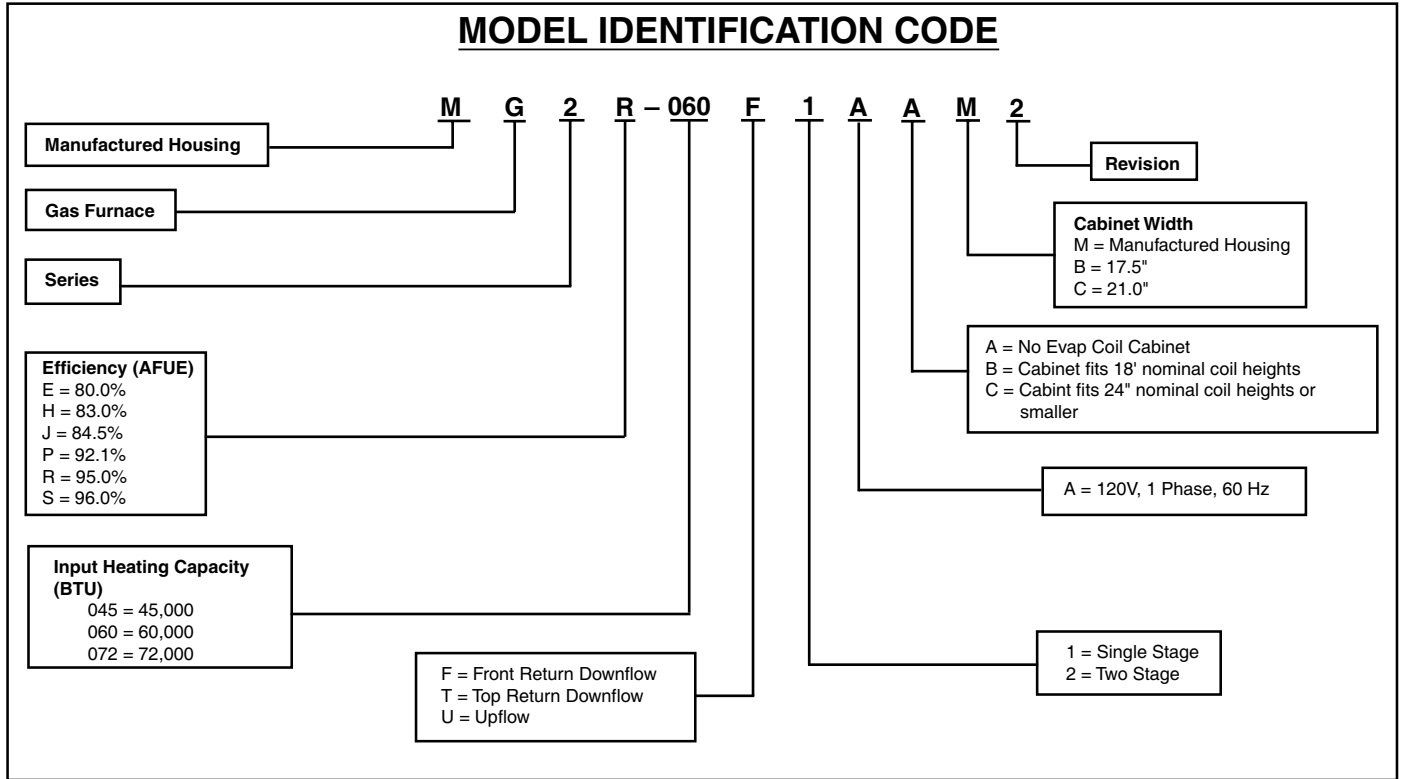

SPECIFICATIONS

MG2R MODEL NUMBERS:	045F	045T	060F	060T	072F	072T
Input (BTUH)*	45000	45000	60000	60000	72000	72000
Heating Capacity (BTUH)	42750	42750	57000	57000	68400	68400
AFUE (%)	95	95	95	95	95	95
Motor FLA (Amps)	8.4	8.4	8.4	8.4	8.4	8.4
Rated Ext. SP (in. WC)	0.3	0.3	0.3	0.3	0.3	0.3
Temperature Rise Range (°F)	35-65	25-55	35-65	25-55	35-65	35-65
Fuse or Breaker (Amps)	20	20	20	20	20	20

Note: All models are 115V, 60 Hz, 1 phase. Gas Connections are 1/2" NPT. AFUE = Annual Fuel Utilization Efficiency
 * Ratings to 2,000 ft. Over 2,000 ft. reduce 4% for each 1,000 ft. above sea level.

MILLER

MG2R GAS FURNACES

BLOWER PERFORMANCE



BLOWER PERFORMANCE - FRONT RETURN HEATING

Heating Airflow (CFM) & Temperature Rise (°F)											
Model Number & Heating Input (BTUH)	Motor Speed	External Static Pressure (Inches Water Column)									
		0.1		0.2		0.3		0.4		0.5	
		CFM	Rise	CFM	Rise	CFM	Rise	CFM	Rise	CFM	Rise
MG2R 045F 45,000 BTU/Hr	5 - High										
	4 - Med-High										
	3 - Medium										
	2 - Med-Low			927	36	867	38	811	41	750	44
	1 - Low	757	44	669	50	618	54	546	61		
MG2R 060F 60,000 BTU/Hr	5 - High										
	4 - Med-High										
	3 - Medium	1,242	36	1,196	37	1,156	38	1,111	40	1,069	42
	2 - Med-Low	950	47	903	49	857	52	806	55	741	60
	1 - Low	757	59								
MG2R-072F 72,000 BTU/Hr	5 - High										
	4 - Med-High										
	3 - Medium	1,276	42	1,232	43	1,191	45	1,151	46	1,103	48
	2 - Med-Low	1,124	47	1,084	49	1,028	52	980	54	930	57
	1 - Low										

NOTES:

1. Data is shown without filter.
2. Temperature rises in the table are approximate. Actual temperature rises may vary.
3. Individual cells shaded in gray indicate a temperature rise outside of the recommended range.
4. To comply with government mandated efficiency standards, speed settings shaded in gray are not allowed in HEAT mode.
5. The "***" denotes the factory heat setting and "****" denotes the factory cool setting. If the Alternate speed is to be used, the speed tap must be adjusted at the blower motor plug.

BLOWER PERFORMANCE - FRONT RETURN COOLING

Cooling Airflow (CFM)										
Model Number & Heating Input (BTUH)	Motor Speed	External Static Pressure (Inches Water Column)								
		0.1	0.2	0.3	0.4	0.5	0.6	0.7	0.8	
		CFM	CFM	CFM	CFM	CFM	CFM	CFM	CFM	
MG2R 045F 45,000 BTU/Hr	5 - High	1,605	1,565	1,524	1,489	1,452	1,416	1,381	1,341	
	4 - Med-High	1,381	1,337	1,293	1,248	1,204	1,160	1,114	1,062	
	3 - Medium	1,278	1,234	1,192	1,150	1,111	1,057	997	941	
	2 - Med-Low	978	927	867	811	750	698	639	595	
	1 - Low	757	669	618	546	502	476	447	432	
MG2R 060F 60,000 BTU/Hr	5 - High	1,614	1,570	1,533	1,499	1,463	1,421	1,385	1,347	
	4 - Med-High	1,409	1,365	1,326	1,285	1,242	1,198	1,147	1,095	
	3 - Medium	1,242	1,196	1,156	1,111	1,069	1,016	953	902	
	2 - Med-Low	950	903	857	806	741	686	641	601	
	1 - Low	757	669	618	546	502	476	447	432	
MG2R-072F 72,000 BTU/Hr	5 - High	1,560	1,523	1,484	1,445	1,407	1,367	1,329	1,290	
	4 - Med-High	1,443	1,400	1,354	1,311	1,264	1,220	1,175	1,132	
	3 - Medium	1,276	1,232	1,191	1,151	1,103	1,055	1,006	962	
	2 - Med-Low	1,124	1,084	1,028	980	930	875	823	778	
	1 - Low	717	647	603	512	433	375	307	244	

NOTES:

1. Data is shown without filter.

MILLER

MG2S GAS FURNACES

96% - TWO STAGE



- FER compliant, 2 stage with integral coil cabinet
- 2 stage gas valve; 2 stage inducer
- ECM blower (includes 40V transformer)
- 100% fired and tested
- Sealed combustion approved for direct vent furnace, category IV venting system - may be vertically or horizontally vented using a 2-pipe system for maximum flexibility in installation
- Natural gas with LP conversion kit
- Hot surface ignitor with Smartlite technology
- Tubular primary heat exchanger
- Stainless steel secondary heat exchanger
- Fixed 30-second blower delay
- Fixed 30-second post purge
- 60-second fixed cooling cycle blower-off delay (TDR)
- Easy troubleshooting diagnostic lights
- 3 amp fuse protection against low voltage shorts
- Low voltage terminal board
- Color-coded wire harness



PLEASE NOTE:

MG2S furnaces are not approved for residential or modular home applications — only for manufactured housing.

RESIDENTIAL REGISTERED WARRANTY

Effective on product manufactured after 4-1-19. Original homeowner only. Product must be registered within 60 days of installation date. (†)

- 5 year parts, 20 year heat exchanger, 1 year labor

RESIDENTIAL NON-REGISTERED WARRANTY

Effective on product manufactured after 4-1-19. Original homeowner only.

- 1 year parts, 20 year heat exchanger, 1 year labor

For Contractors' Preferred Protection Plans, contact your R. A. Townsend Co. representative.

(†) IMPORTANT WARRANTY NOTE:

In order to be eligible for the full registered warranty and Quality Pledge, the consumer or Nortek dealer must register within 60 days of the later date of either installation or occupancy. If registration is not completed within 60 days, the warranty reverts to the non-registered (base standard) warranty.

The warranty registration form must be completed online at www.nortekhvawarranty.com/index.aspx. For registration assistance, please call 866-319-9592.

ID ORDER#	MODEL#	MBH CAPACITY IN	MBH CAPACITY OUT	AFUE	VENT SIZE	DIMENSIONS W x D x H
737617	MG2S-060F2ABM2	60,000/39,000	57,000/37,440	96.0	2" or 3"	19-7/8" x 24-5/8" x 76"
737620	MG2S-072F2ABM2	72,000/47,000	69,120/45,120	96.0	2" or 3"	19-7/8" x 24-5/8" x 76"

FOR SPECIFICATIONS & BLOWER PERFORMANCE, SEE PAGES 504.6-504.7

FOR ACCESSORIES, SEE PAGES 504.12-504.13

FOR AIR CONDITIONING COILS, SEE PAGE 504.16

MAXIMUM DIRECT VENT, DUAL PIPE LENGTH (FT.)		
MG2S INPUTS (BTU)	INLET/OUTLET 2" DIAMETER	INLET/OUTLET 3" DIAMETER
45,000	30	60
60,000	30	60 ◆
72,000	30	60

◆ For the 60,000 BTU top return furnace, the length of the 3" diameter pipe must not be longer than 30 feet.

MAXIMUM DIRECT VENT NOTES:

1. Subtract 2.5 ft. for each additional 2" long radius elbow; subtract 5 ft. for each additional 2" short radius elbow; subtract 3.5 ft. for each additional 3" long radius elbow; and subtract 7 ft. for each additional 3" short radius elbow.
2. Two 45° elbows are equivalent to one 90° elbow.
3. This table applies to elevations from sea level to 2,000 ft. For higher elevations, decrease pipe lengths by 8% per 1,000 ft. of altitude.

MILLER

MG2S GAS FURNACES

SPECIFICATIONS

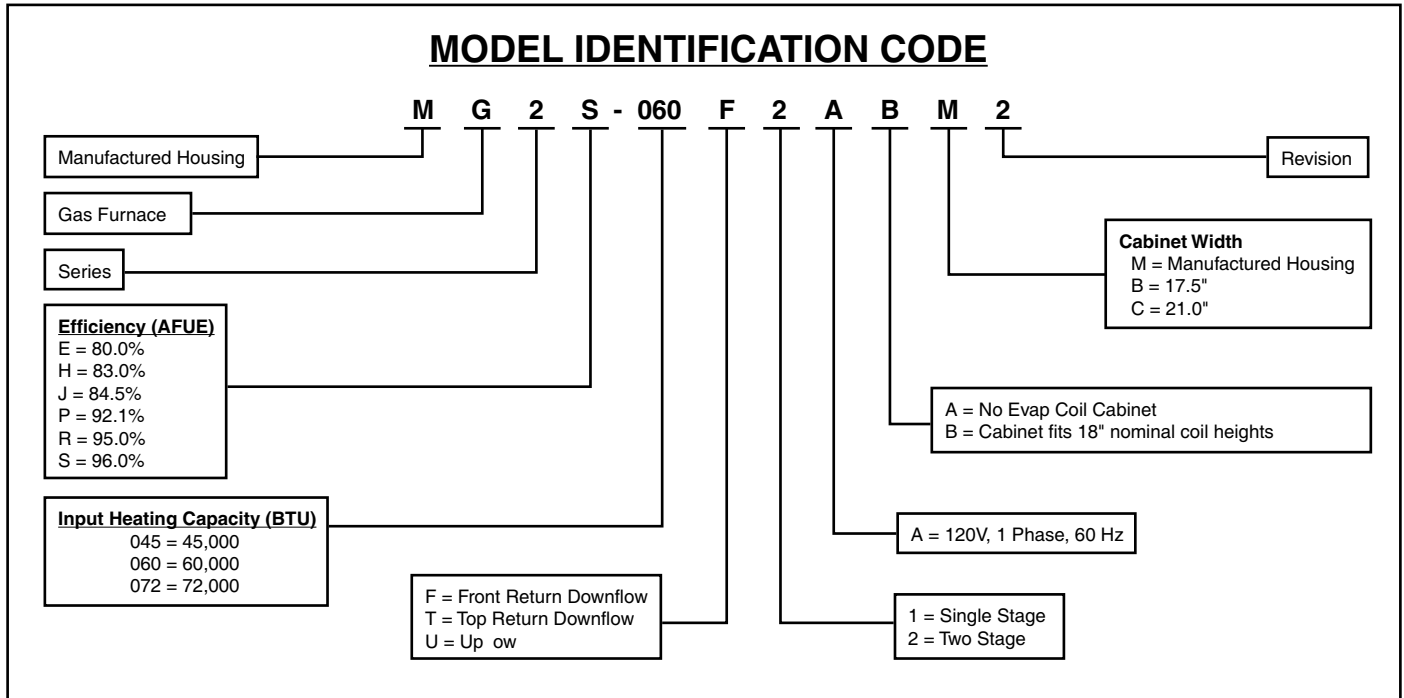

SPECIFICATIONS

MG2S MODEL NUMBERS:	045	060	072
Input (BTUH)*	45,000/29,000	60,000/39,000	72,000/47,000
Heating Capacity (BTUH)	43,200/27,840	57,600/37,440	69,120/45,120
AFUE (%)	96	96	96
Supply Voltage	115V/60Hz/1 Phase		
Blower D x W (in.)	11 x 8	11 x 8	11 x 8
Motor HP	3/4	3/4	3/4
Motor FLA (Amps)	8.4	8.4	8.4
Rated Ext. SP (in. WC)	0.3	0.3	0.3
Temperature Rise Range (°F)	30-60	30-60	35-65
Max Amps	11.7	11.7	11.7
Fuse or Breaker (Amps)	15	15	15

Note: Gas Connections are 1/2" NPT. AFUE = Annual Fuel Utilization Efficiency
 * Ratings to 2,000 ft. Over 2,000 ft. reduce 4% for each 1,000 ft. above sea level.

MILLER

MG2S GAS FURNACES BLOWER PERFORMANCE



BLOWER PERFORMANCE - Front Return

MODEL NUMBER	MOTOR SWITCH SETTINGS (0 =OFF,1 =ON)				COOLING				HEATING							
					EXTERNAL STATIC PRESSURE (IN.W.C.)				EXTERNAL STATIC PRESSURE (IN.W.C.)							
					0.2	0.3	0.4	0.5	0.2		0.3		0.4		0.5	
	1/5	2/6	3/7	4/8	CFM	CFM	CFM	CFM	CFM	RISE	CFM	RISE	CFM	RISE	CFM	RISE
MG2S-045F*	0	0	0	0	913	868	841	795	913	44	868	46	841	48	795	50
	1	0	0	0	965	944	886	848	965	41	944	42	886	45	848	47
	0	1	0	0	1037	1000	973	933	1037	39	1000	40	973	41	933	43
	1	1	0	0	1112	1079	1047	1012	1112	36	1079	37	1047	38	1012	40
	0	0	1	0	1185	1155	1118	1082	1185	34	1155	35	1118	36	1082	37
	1	0	1	0	1256	1216	1180	1151	1256	32	1216	33	1180	34	1151	35
	0	1	1	0	1289	1258	1222	1186	1289	31	1258	32	1222	33	1186	34
	1	1	1	0	1354	1319	1283	1247	1354	30	1319	30	1283	31	1247	32
	0	0	0	1	1396	1366	1331	1299								
	1	0	0	1	1442	1411	1379	1351								
	0	1	0	1	1485	1451	1421	1388								
	1	1	0	1	1510	1473	1446	1416								
	0	0	1	1	1550	1517	1494	1460								
	1	0	1	1	1588	1561	1530	1503								
0	1	1	1	1635	1606	1582	1554									
1	1	1	1	1646	1612	1582	1550									
MG2S-060F*	0	0	0	0	913	868	841	795	913	58	868	61	841	63	795	67
	1	0	0	0	965	944	886	848	965	55	944	56	886	60	848	63
	0	1	0	0	1037	1000	973	933	1037	51	1000	53	973	55	933	57
	1	1	0	0	1112	1079	1047	1012	1112	48	1079	49	1047	51	1012	53
	0	0	1	0	1185	1155	1118	1082	1185	45	1155	46	1118	48	1082	49
	1	0	1	0	1256	1216	1180	1151	1256	42	1216	44	1180	45	1151	46
	0	1	1	0	1289	1258	1222	1186	1289	41	1258	42	1222	44	1186	45
	1	1	1	0	1354	1319	1283	1247	1354	39	1319	40	1283	42	1247	43
	0	0	0	1	1396	1366	1331	1299								
	1	0	0	1	1442	1411	1379	1351								
	0	1	0	1	1485	1451	1421	1388								
	1	1	0	1	1510	1473	1446	1416								
	0	0	1	1	1550	1517	1494	1460								
	1	0	1	1	1588	1561	1530	1503								
0	1	1	1	1635	1606	1582	1554									
1	1	1	1	1646	1612	1582	1550									
MG2S-072F	0	0	0	0	923	884	843	798	923	69	884	72	843	76	798	80
	1	0	0	0	964	922	886	843	964	66	922	69	886	72	843	76
	0	1	0	0	1052	1017	977	938	1052	61	1017	63	977	66	938	68
	1	1	0	0	1117	1088	1049	1017	1117	57	1088	59	1049	61	1017	63
	0	0	1	0	1196	1163	1131	1092	1196	54	1163	55	1131	57	1092	59
	1	0	1	0	1258	1219	1190	1151	1258	51	1219	53	1190	54	1151	56
	0	1	1	0	1283	1248	1213	1177	1283	50	1248	51	1213	53	1177	54
	1	1	1	0	1335	1299	1268	1234	1335	48	1299	49	1268	50	1234	52
	0	0	0	1	1389	1356	1322	1292	1389	46	1356	47	1322	48	1292	50
	1	0	0	1	1442	1406	1374	1340	1442	44	1406	46	1374	47	1340	48
	0	1	0	1	1480	1446	1415	1382	1480	43	1446	44	1415	45	1382	46
	1	1	0	1	1506	1475	1442	1410	1506	42	1475	43	1442	44	1410	45
	0	0	1	1	1542	1507	1474	1443	1542	42	1507	42	1474	43	1443	44
	1	0	1	1	1583	1554	1518	1488	1583	40	1554	41	1518	42	1488	43
	0	1	1	1	1630	1601	1563	1530	1630	39	1601	40	1563	41	1530	42
	1	1	1	1	1633	1599	1564	1529								

Greyed out blower speeds do not meet FER efficiency requirements and should not be used.

MG1E ATMOSPHERIC GAS FURNACES
80% — SINGLE STAGE



- FER compliant, single stage
- Hot surface ignition
- Natural gas with LP conversion kit (†)
- Sealed combustion system
- 120V, 60 Hz, 1 phase
- 24, 60 Hz, 30 VAC thermostat circuit
- 1/4" NFPT gas connection
- 45°F - 75°F temperature rise
- Permanent, washable air filter
- High efficiency drum heat exchanger
- Fully-insulated cabinet
- Reliable burner
- Designed for all sizes of manufactured and modular homes



RESIDENTIAL WARRANTY

Effective on product manufactured after 4-1-19. Original homeowner only. (†)

- 1 year parts, 20 year heat exchanger, 1 year labor

For Contractors' Preferred Protection Plans, contact your R. A. Townsend Co. representative.

(†) IMPORTANT WARRANTY NOTE:

In order to be eligible for the full registered warranty and quality pledge, the consumer or Nortek dealer must register within 60 days of the later date of either installation or occupancy. If registration is not completed within 60 days, the warranty reverts to the non-registered (base standard) warranty.

ID ORDER#	MODEL#	AFUE	A/C READY TONS	HEATING		DIMENSIONS W x D x H
				INPUT BTUH	OUTPUT BTUH	
AAW SERIES (Without integral A/C coil cabinet)						
741143	MG1E-056F1AAM2	80.0	4.0	56,000	45,000	20" x 23-3/4" x 56"
741164	MG1E-070F1AAM2	80.0	4.0	70,000	57,000	20" x 23-3/4" x 56"
741168	MG1E-077F1AAM2	80.0	4.0	77,000	62,000	20" x 23-3/4" x 56"
741172	MG1E-090F1AAM2	80.0	4.0	85,000	68,000	20" x 23-3/4" x 56"
ABW SERIES (With integral A/C coil cabinet)						
741156	MG1E-056F1ABM2	80.0	4.0	56,000	45,000	20" x 23-3/4" x 76"
741165	MG1E-070F1ABM2	80.0	4.0	70,000	57,000	20" x 23-3/4" x 76"
741170	MG1E-077F1ABM2	80.0	4.0	77,000	62,000	20" x 23-3/4" x 76"
741176	MG1E-090F1ABM2	80.0	4.0	85,000	68,000	20" x 23-3/4" x 76"

FOR SPECIFICATIONS & BLOWER PERFORMANCE, SEE PAGES 504.9-504.11

FOR ACCESSORIES, SEE PAGES 504.12-504.13

FOR AIR CONDITIONING COILS, SEE PAGE 504.16

FOR ADDITIONAL INFORMATION, VISIT THE NORTEK WEBSITE AT www.nortekhvac.com

MILLER

MG1E ATMOSPHERIC GAS FURNACES SPECIFICATIONS

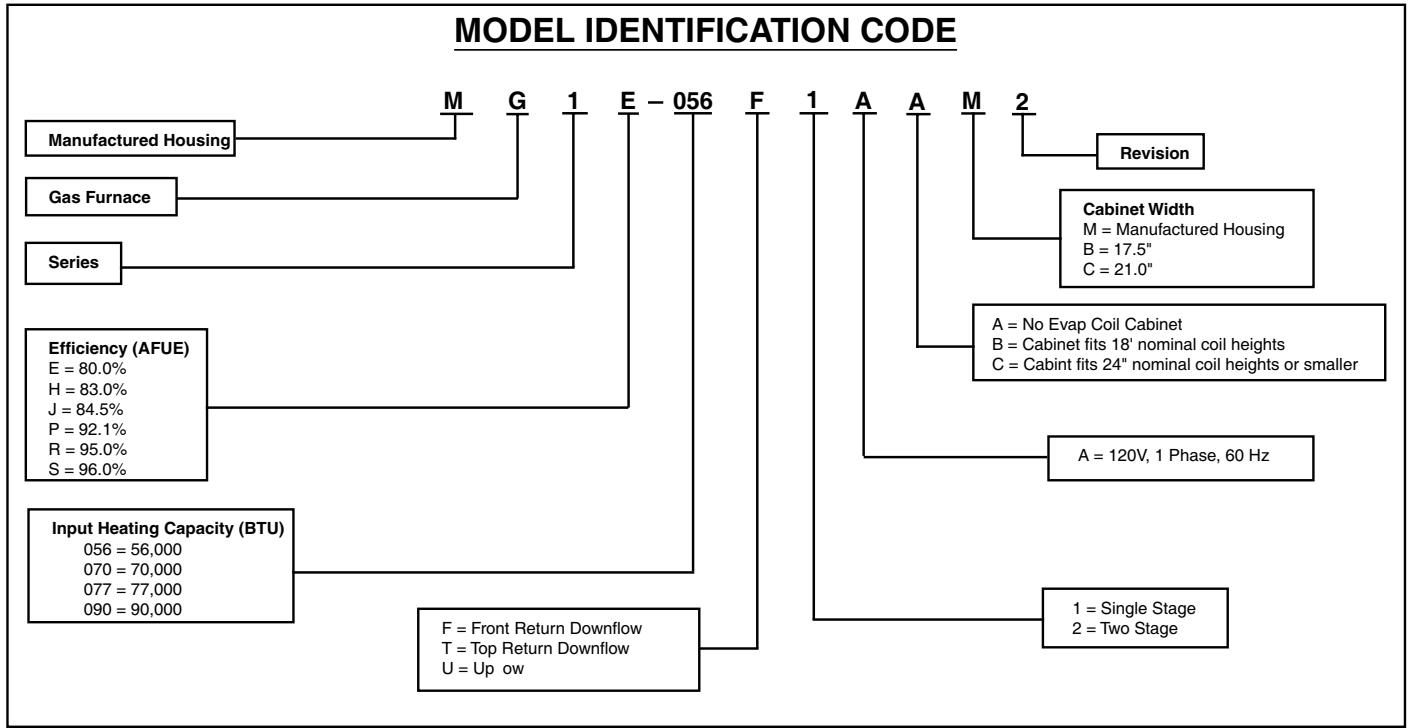

SPECIFICATIONS

Furnace Model No	Input	Output	Orifice Number		ESP in WC	Motor HP	Motor FLA	A / C Ready Tons	AFUE %	Shipping Weight	
			Nat	LP						A Cabinet	B Cabinet
MG1E-056	56000	45000	29	45	0.3	3/4	8.4	4	80%	157	171
MG1E-070	70000	57000	24	42	0.3	3/4	8.4	4	80%	157	171
MG1E-077	77000	62000	21	40	0.3	3/4	8.4	4	80%	157	171
MG1E-090	85000	68000	17	36	0.3	3/4	8.4	4	80%	157	171

Electrical Supply - 120 volts, 60HZ, 1 Ph.
 Fuse or Breaker - 15 amps
 Temperature Rise - 45° to 75°F
 Gas Connection - 1/2" NFPT
 High Altitude - Tables in the Installation Instructions for elevations above 2,000 feet.

Thermostat Circuit - 24 volts, 60HZ, 30 vac
 Normal Anticipator Setting - 0.4
 Manifold Pressure - Natural Gas: 3.5" w.c. LP Gas: 10" w.c.

MG1E ATMOSPHERIC GAS FURNACES
BLOWER PERFORMANCE



BLOWER PERFORMANCE

Heating Airflow (CFM) & Temperature Rise (°F)

WHAT'S INSIDE MATTERS®

MG1E-056F1A(A,B)M2											
MODEL NAME/ HEATING INPUT	MOTOR SPEED	EXTERNAL STATIC PRESSURE (IN. W.C.)									
		0.1		0.2		0.3		0.4		0.5	
		CFM	RISE	CFM	RISE	CFM	RISE	CFM	RISE	CFM	RISE
MG1E-056F1AAM2 56,000 BTU/Hr	5 - High										
	4 - Alternate										
	3 - Med-Hi*					928	45	876	47	829	50
	2 - Med-Low	890	47	843	49	790	53	735	56	683	61
	1 - Low	798	52	749	55	695	60	629	66		

MG1E-070F1A(A,B)M2											
MODEL NAME/ HEATING INPUT	MOTOR SPEED	EXTERNAL STATIC PRESSURE (IN. W.C.)									
		0.1		0.2		0.3		0.4		0.5	
		CFM	RISE	CFM	RISE	CFM	RISE	CFM	RISE	CFM	RISE
MG1E-070F1AAM2 70,000 BTU/Hr	5 - High										
	4 - Alternate										
	3 - Med-High*	1,212	43	1,178	44	1,148	45	1,114	47	1,079	48
	2 - Med-Low	931	56	886	59	836	62	782	66	732	71
	1 - Low										

MG1E-077F1AAM2											
MODEL NAME/ HEATING INPUT	MOTOR SPEED	EXTERNAL STATIC PRESSURE (IN. W.C.)									
		0.1		0.2		0.3		0.4		0.5	
		CFM	RISE	CFM	RISE	CFM	RISE	CFM	RISE	CFM	RISE
MG1E-077F1AAM2 77,000 BTU/Hr	5 - High										
	4 - Alternate										
	3 - Med-High*	1,212	47	1,178	48	1,148	50	1,114	51	1,079	53
	2 - Med-Low	996	57	960	59	924	62	885	64	848	67
	1 - Low										

MG1E-090F1AAM2											
MODEL NAME/ HEATING INPUT	MOTOR SPEED	EXTERNAL STATIC PRESSURE (IN. W.C.)									
		0.1		0.2		0.3		0.4		0.5	
		CFM	RISE	CFM	RISE	CFM	RISE	CFM	RISE	CFM	RISE
MG1E-090F1AAM2 85,000 BTU/Hr	5 - High										
	4 - Med-High										
	3 - Med-Low*	1,188	56	1,154	58	1,119	60	1,091	61	1,054	63
	2 - Alternate	1,015	66	978	68	956	70	917	73		
	1 - Low										

NOTES:

1. To comply with government mandated efficiency standards, two openings are required for air flows above 1,600 CFM.
2. Data is shown without filter.
3. Temperature rises in the table are approximate. Actual temperature rises may vary.
4. To comply with government mandated efficiency standards, speed settings shaded in gray are not allowed in HEAT mode.
5. The "*" denotes the factory heat and cool setting. If a different motor speed is needed, the appropriate wire from the "HEAT" or "COOL" tap on the control board must be connected to the desired Tap (1-5) at the motor.

MG1E ATMOSPHERIC GAS FURNACES
BLOWER PERFORMANCE



BLOWER PERFORMANCE (cont.)

Cooling Airflow (CFM)

MG1E-056F1AAM2									
MODEL NAME/ HEATING INPUT	MOTOR SPEED	EXTERNAL STATIC PRESSURE (IN. W.C.)							
		0.1	0.2	0.3	0.4	0.5	0.6	0.7	0.8
		CFM	CFM	CFM	CFM	CFM	CFM	CFM	CFM
MG1E-056F1AAM2 56,000 BTU/Hr	5 - High*	1,524	1,491	1,458	1,421	1,385	1,348	1,308	1,270
	4 - Alternate	1,199	1,160	1,122	1,080	1,037	993	946	899
	3 - Med-High	1,013	972	928	876	829	780	728	675
	2 - Med-Low	890	843	790	735	683	615	566	510
	1 - Low	798	749	695	629	442	369		

MG1E-070F1AAM2									
MODEL NAME/ HEATING INPUT	MOTOR SPEED	EXTERNAL STATIC PRESSURE (IN. W.C.)							
		0.1	0.2	0.3	0.4	0.5	0.6	0.7	0.8
		CFM	CFM	CFM	CFM	CFM	CFM	CFM	CFM
MG1E-070F1AAM2 70,000 BTU/Hr	5 - High*	1,573	1,541	1,511	1,479	1,452	1,419	1,388	1,358
	4 - Alternate	1,387	1,353	1,321	1,289	1,254	1,216	1,183	1,148
	3 - Med-High	1,212	1,178	1,148	1,114	1,079	1,036	1,005	964
	2 - Med-Low	931	886	836	782	732	670	620	565
	1 - Low	640	599	562	513	476	425		

MG1E-077F1AAM2									
MODEL NAME/ HEATING INPUT	MOTOR SPEED	EXTERNAL STATIC PRESSURE (IN. W.C.)							
		0.1	0.2	0.3	0.4	0.5	0.6	0.7	0.8
		CFM	CFM	CFM	CFM	CFM	CFM	CFM	CFM
MG1E-077F1AAM2 77,000 BTU/Hr	5 - High*	1,573	1,541	1,511	1,479	1,452	1,419	1,388	1,358
	4 - Alternate	1,333	1,300	1,268	1,236	1,201	1,162	1,129	1,093
	3 - Med-High	1,212	1,178	1,148	1,114	1,079	1,036	1,005	964
	2 - Med-Low	996	960	924	885	848	814	772	734
	1 - Low	683	642	599	540	498	451	386	

MG1E-090F1AAM2									
MODEL NAME/ HEATING INPUT	MOTOR SPEED	EXTERNAL STATIC PRESSURE (IN. W.C.)							
		0.1	0.2	0.3	0.4	0.5	0.6	0.7	0.8
		CFM	CFM	CFM	CFM	CFM	CFM	CFM	CFM
MG1E-085F1AAM2 85,000 BTU/Hr	5 - High*	1,590	1,555	1,521	1,493	1,458	1,426	1,397	1,371
	4 - Med-High	1,337	1,306	1,274	1,243	1,210	1,182	1,142	1,104
	3 - Med-Low	1,188	1,154	1,119	1,091	1,054	1,023	984	941
	2 - Alternate	1,015	978	956	917	871	834	792	740
	1 - Low	779	742	698	654	617	564	516	472

NOTES:

1. To comply with government mandated efficiency standards, two openings are required for air flows above 1,600 CFM.
2. Data is shown without filter.
3. The "*" denotes the factory heat and cool setting. If a different motor speed is needed, the appropriate wire from the "HEAT" or "COOL" tap on the control board must be connected to the desired Tap (1-5) at the motor.

MILLER FURNACE ACCESSORIES



ID ORDER#	MODEL#	MILLER#	DESCRIPTION
MG2R SERIES ACCESSORIES			
77688	--	911969A	COIL CABINET , white
191313	--	901083	AUTOMATIC DAMPER KIT , fits in coil cavity
236367	--	904106	VENT CONVERSION KIT , converts roofjacks to accept (2) 2" PVC pipes for high efficiency furnace installations
442214	CVENT-2	904952	CONCENTRIC VENT , 2"
442213	CVENT-3	904953	Same as above, but 3"
48623	--	901987A	DUCT CONNECTOR , 11" x 13.25" x .88"
75721	--	901988A	Same as above, but 11" x 13.25" x 2.00"
75722	--	901989A	Same as above, but 11" x 13.25" x 4.25"
75723	--	901990A	Same as above, but 11" x 13.25" x 6.25"
75724	--	901991A	Same as above, but 11" x 13.25" x 8.25"
MG2S SERIES ACCESSORIES			
191313	--	901083	AUTOMATIC DAMPER KIT , fits in coil cavity
442214	CVENT-2	904952	CONCENTRIC VENT , 2"
442213	CVENT-3	904953	Same as above, but 3"
237277	--	904953	NEUTRALIZER KIT
236367	--	904106	VENT CONVERSION KIT , converts roofjacks to accept (2) 2" PVC pipes for high efficiency furnace installations
569309	--	904617	SIDE WALL VENT KIT , 2"
569204	--	904347	Same as above, but 3"
48623	--	901987A	DUCT CONNECTOR , 11" x 13.25" x .88"
75721	--	901988A	Same as above, but 11" x 13.25" x 2.00"
75722	--	901989A	Same as above, but 11" x 13.25" x 4.25"
75723	--	901990A	Same as above, but 11" x 13.25" x 6.25"
75724	--	901991A	Same as above, but 11" x 13.25" x 8.25"

FOR ADDITIONAL INFORMATION, VISIT
THE NORTEK WEBSITE AT www.nortekhvac.com

SEPTEMBER 2024

Line #4950/4952

MILLER FURNACE ACCESSORIES

504.13



ID ORDER#	MODEL#	MILLER#	DESCRIPTION
MG1E SERIES ACCESSORIES			* = SPECIAL ORDER ITEM
77688	--	911969A	COIL CABINET , white
191313	--	901083	AUTOMATIC DAMPER KIT , fits in coil cavity
140640	--	902521	FLAT CEILING PLATE , 2-piece
48623	--	901987A	DUCT CONNECTOR , 11" x 13.25" x .88"
75721	--	901988A	Same as above, but 11" x 13.25" x 2.00"
75722	--	901989A	Same as above, but 11" x 13.25" x 4.25"
75723	--	901990A	Same as above, but 11" x 13.25" x 6.25"
75724	--	901991A	Same as above, but 11" x 13.25" x 8.25"
202485	--	903893	ROOF JACK ADAPTER (ROOF WEDGE) , 2.5/12 pitch, 21"W x 30"D, for MI series and CMF series
202486	--	903894	Same as above, but 3.0/12 pitch, 21"W x 30-3/4"D
202487	--	903895	Same as above, but 4.0/12 pitch, 21"W x 31-1/2"D
160594	FAW1523-0A	903658	ROOF JACK ASSEMBLY , with flat flashing, "all weather," 15" - 23", with 5" flue pipe
718084 *	FAW2135-0A	903659	Same as above, but 21" - 35"
160287	FAW2747-0A	903660	Same as above, but 27" - 47"
161419	SAW2135-2A	903662	ROOF JACK ASSEMBLY , with slant flashing, "all weather," 2.5/12 pitch, 21" - 35", with 5" flue pipe
161420	SAW2747-2A	903663	Same as above, but 27" - 47"
160599	SAW3563-2A	903664	Same as above, but 35" - 63"
190779	SAW2747-4A	903678A	Same as above, but 27" - 47" and 4/12 pitch
190781	SAW3563-4A	903665A	Same as above, but 35 - 63"
160602	SAW5195-4A	903666A	Same as above, but 51" - 95"
76936	--	901935	INTERNAL EXTENSION , includes (1) 5"x10" inner pipe and (1) 8"x10" outer pipe
94323	--	901937	EXTERNAL EXTENSION , includes (1) 5-1/2"x16-1/2" inner pipe and (1) 8-1/2"x16" outer pipe
MISCELLANEOUS ACCESSORIES			
154172	--	901996B	AUTOMATIC DAMPER KIT , fits in the base of the furnace
161421	--	903656	STANDARD "ALL WEATHER" ROOF CAP
139049	--	901995	CONTROL BOX , 5-wire,

**FOR ADDITIONAL INFORMATION, VISIT
THE NORTEK WEBSITE AT www.nortekhv.com**

HSA1BD CONDENSERS
13 SEER - 1.5 TO 5 TON CAPACITY



• 13 SEER, R-410A (◆)

Note 1: When matched with Nortek variable speed air handler or Nortek variable speed blower kits, **the HSA1BD is rated up to 14 SEER**

Note 2: To match your condensing unit and coil for an accurate SEER rating, visit the Nortek website at www.nortekhv.com

- Composite base pan
- Louvered condenser guard
- Removable top grille assembly
- High pressure switch
- Liquid line filter drier (field installed)
- One-piece top/orifice
- Easy compressor and control access
- All-aluminum coils
- Servicer-friendly jacket



RESIDENTIAL REGISTERED WARRANTY

Effective on product manufactured after 4-1-19. Original homeowner only. Product must be registered within 60 days of installation date. (††)

- 10 year parts, 10 year compressor, 1 year labor

RESIDENTIAL NON-REGISTERED WARRANTY

Effective on product manufactured after 4-1-19. Original homeowner only.

- 1 year parts, 5 year compressor, 1 year labor

For Contractors' Preferred Protection Plans, contact your R. A. Townsend Co. representative.

(†) IMPORTANT WARRANTY NOTE:

In order to be eligible for the full registered warranty and quality pledge, the consumer or Nortek dealer must register within **60** days of the later date of either installation or occupancy. If registration is not completed within **60** days, the warranty reverts to the non-registered (base standard) warranty.

ID ORDER#	MODEL#	SEER (◆)	NOM. TONS	NOM. COOLING(††) CAPACITY BTUH	DIMENSIONS W x D x H
1 PHASE CONDENSERS (208/230V, 60 hz)					
* = SPECIAL ORDER ITEM					
725231 *	HSA1BD4M1SN18K	13	1.5	18,000	23-3/4" x 23-3/4" x 24-1/2"
725234 *	HSA1BD4M1SN24K	13	2.0	24,000	23-3/4" x 23-3/4" x 24-1/2"
725235 *	HSA1BD4M1SN30K	13	2.5	30,000	23-3/4" x 23-3/4" x 28-1/2"
725236 *	HSA1BD4M1SN36K	13	3.0	36,000	23-3/4" x 23-3/4" x 28-1/2"
725237 *	HSA1BD4M1SN42K	13	3.5	42,000	31-3/4" x 31-3/4" x 29-1/4"
725238 *	HSA1BD4M1SN48K	13	4.0	48,000	31-3/4" x 31-3/4" x 29-1/4"
725239 *	HSA1BD4M1SN60K	13	5.0	60,000	31-3/4" x 31-3/4" x 33-1/4"

FOR SPECIFICATIONS, SEE PAGE 504.15

FOR COILS, SEE PAGE 504.16

FOR SPLIT SYSTEM ACCESSORIES, SEE PAGE 504.17

FOR ADDITIONAL INFORMATION, VISIT THE NORTEK WEBSITE AT www.nortekhv.com

OUTPUT NOTE (††): Output capacity may vary slightly. See Nortek website (www.nortekhv.com) or current AHRI directory (www.ahridirectory.com) for certified combinations and ratings.

MILLER

HSA1BD CONDENSERS

SPECIFICATIONS

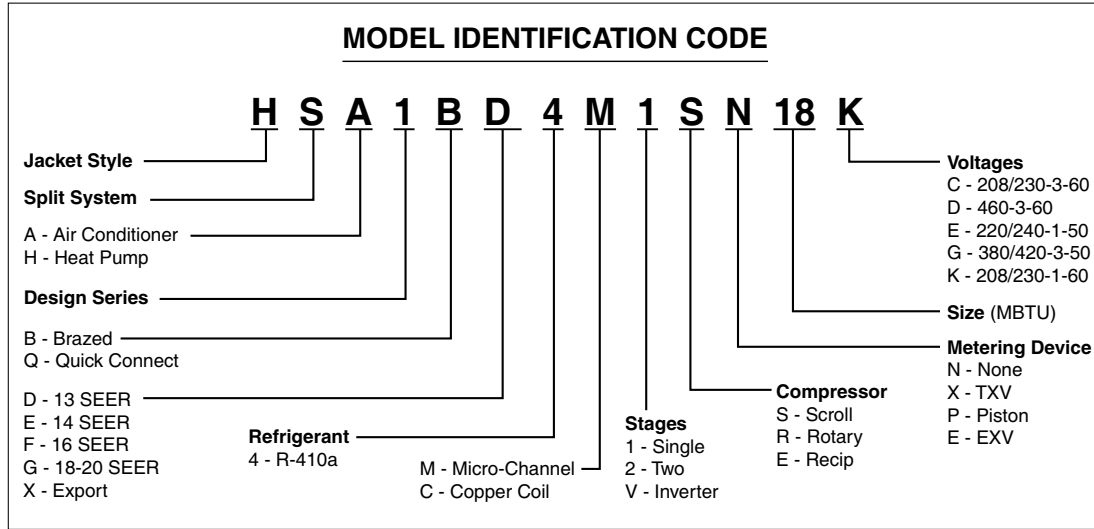

PHYSICAL AND ELECTRICAL SPECIFICATIONS / OUTDOOR UNITS

13 SEER — High Efficiency — Single Phase

Model Number HSA1(B,Q)D		18K (5)	24K	30K	36K	42K	48K	60K	
Electrical Data	Volts-Cycles-Phase (1)	208/230-60-1	208/230-60-1	208/230-60-1	208/230-60-1	208/230-60-1	208/230-60-1	208/230-60-1	
	Total Amps	9.7	13.5	14.8	18.0	19.3	23.2	27.6	
	Max. Overcurrent Protection (2)	20	25	30	35	40	50	60	
	Min. Circuit Ampacity	12.0	16.7	18.3	22.0	23.0	28.6	34.2	
	Fan Motor	Type	PSC	PSC	PSC	PSC	PSC	PSC	PSC
		Amps	0.35	0.7	0.7	1.4	1.4	1.4	1.4
		HP	0.13	0.13	0.13	0.25	0.25	0.25	0.25
	Fan Blade	Dia - # Blades	18" - 3	18" - 3	18" - 3	18" - 4	24" - 2	24" - 2	24" - 2
		SCFM	2600	2800	3000	3000	3500	3500	3800
	Compressor Data	RLA	9.3	12.8	14.1	16.6	17.9	21.8	26.2
LRA		56.6	58.3	73.0	79.0	112.0	117.0	134.0	
Refrigerant suction line O.D. NOTE: Liquid line is 3/8" O.D. for entire length	0-24 ft.	3/4"	3/4"	3/4"	3/4"	7/8"	7/8"	7/8"	
	25-39 ft.	3/4"	3/4"	3/4"	7/8" (3)	7/8"	7/8"	1-1/8" (4)	
	40-75 ft.	3/4"	3/4"	3/4"	7/8" (3)	7/8"	7/8"	1-1/8" (4)	
Approximate Weight (lbs.)	Net	129	126	133	140	195	197	217	
	Ship	138	135	142	149	205	207	228	
Sound Rating db		74	74	74	76	79	78	79	

- (1) Operating Voltage Range: 187v min. - 253v max.
- (2) HACR Type Circuit Breakers may be used.
- (3) Requires 7/8" to 3/4" reducer from line to unit.
- (4) Requires 7/8" to 1-1/8" reducer from line to unit.
- (5) Capacity only available on brazed versions.

COPPER WIRE SIZE - AWG (1% Voltage Drop)				
Supply Wire Length-Feet				Supply Circuit Ampacity
200	150	100	50	
6	8	10	14	15
4	6	8	2	20
4	6	8	0	25
4	4	6	0	30
	4	6	8	35
	4	6	8	40
	3	4	6	45
	3	4	6	50

Wire size based on N.E.C. for 60° type copper conductors.

Nortek Technical Specifications #054F-0918

MILLER C8 & CM4B COILS

13 SEER - VERTICAL - UNCASED



- 13 SEER, R-410A
- Uncased
- Brazed refrigerant connections (downturned)
- Upflow and counterflow applications
- Plastic long-life drain pan and fitting

IMPORTANT
Miller coils cannot be used with a Nortek condenser—not a matched system for extended warranty.

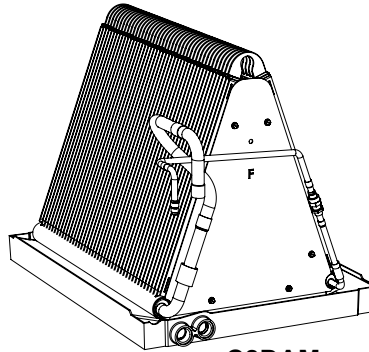

C8DAM

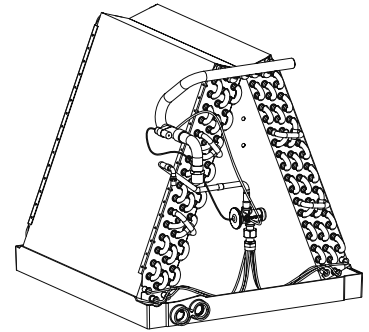

CM4B

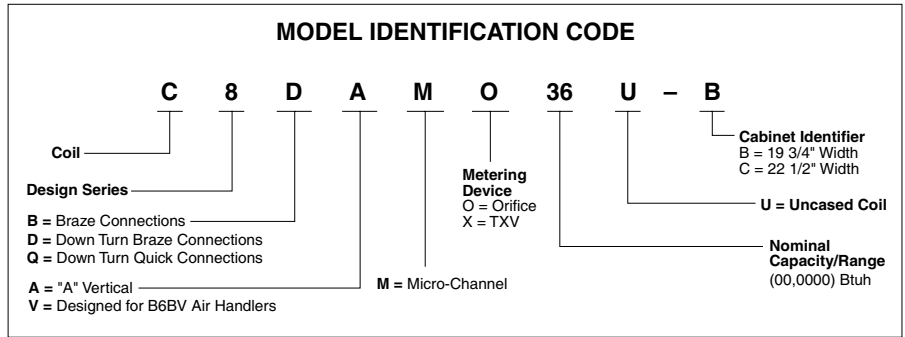

ID ORDER#	MODEL#	SEER	NOM. TONS	NOMINAL AIRFLOW CFM		REFRIGERANT CONNECTIONS		METERING ORIFICE SIZE/TXV
				LOWER TONNAGE	HIGHER TONNAGE	SUCTION	LIQUID	
C8DAM COILS (Micro-channel with metering orifice)								
655597	C8DAM01830U	13	1.5-2.5	600	1,000	3/4" OD	3/8" OD	0.061
664631	C8DAM036U-B	13	3.0	N/A	1,200	3/4" OD	3/8" OD	0.067
CM4B COILS (Copper tubing with TXV)								
642314	CM4B-53U	13	3.5	1,600	1,600	7/8" OD	3/8" OD	TXV
674754	CM4B-54U	13	4.0	--	--	7/8" OD	3/8" OD	TXV

DIMENSIONAL DATA (per Nortek Technical Specification #860D-1117)										
MODEL	CABINET OVERALL DIMENSIONS			CABINET BOTTOM OPENING		CABINET TOP OPENING		COIL ONLY		
	Width	Depth	Height	Width	Depth	Width	Depth	Width	Depth	Height
C8DAM01830U	--	--	--	--	--	--	--	18-1/8"	19-1/2"	18"
C8DAM036U-B	--	--	--	--	--	--	--	18-1/8"	19-1/2"	18"
CM4B-53U	--	--	--	--	--	--	--	18"	19-5/8"	18-1/2"
CM4B-54U	--	--	--	--	--	--	--	18"	19-5/8"	18-1/2"

FOR ADDITIONAL INFORMATION, VISIT THE NORTEK WEBSITE AT www.nortekhvac.com

SEPTEMBER 2024

Line #4951/4952/5182

MILLER

SPLIT SYSTEM ACCESSORIES

504.17



ID ORDER#	MODEL#	DESCRIPTION
190477 *	911656	STUB KIT , with quick-connect end, to be used with sweat linesets, 3/8" x 5/8"
190478 *	911657	<i>Same as above</i> , but 3/8" x 3/4"
190479 *	911658	<i>Same as above</i> , but 3/8" x 7/8"
190481	918080	COOLING ONLY THERMOSTAT , white, 24V, snap action (=White Rodgers #1C21-123)
199862	918081	HEAT/COOL THERMOSTAT , white, 24V, 50°F-90°F, snap action (= White-Rodgers #1C26-123)
192961 *	900759	MULTI-SPEED BLOWER ASSEMBLY , 4 ton, 5-wire, for Coleman 7600 or 7900 Series furnaces
192968 *	911030	5-SPEED BLOWER ASSEMBLY , 4 ton, 5-wire, for Miller MGH and MAC Series furnaces
154166 *	903773	BLOWER ASSEMBLY , 2-3 ton, for Miller M1M Series furnaces
154168 *	903413	<i>Same as above</i> , but 2-4 ton
138960	901998	BLOWER ASSEMBLY , 2-3.5 ton, 10 x 8, for Miller MGHA-01, MMHA-01 and MGHA-01 Series furnaces
139117	902809	BLOWER ASSEMBLY , 2.5-3 ton, 10 x 7, for Miller MGHA-05, MMHA-05 and MGHA-05 Series furnaces

FOR ADDITIONAL INFORMATION, VISIT
THE NORTEK WEBSITE AT www.nortekhvac.com

* = SPECIAL ORDER ITEM

MILLER

P7RE PACKAGED A/C UNITS

14 SEER



- 14 SEER, R-410A
- Quality compressor
- High pressure switches
- All-aluminum coils
- ECM blower motor
- Permanently-lubricated condenser motor
- Low voltage transformer
- Liquid line filter drier (factory installed)
- Galvanized steel with a polyester urethane coat finish
- Compact footprint and profile
- 0" clearance to combustibles on duct side of the unit
- Epoxy-coated wire guard and plastic mesh hail guard
- Raised base pan
- Easy access to compressor, controls and evaporator coil
- Drain trap
- Removable top grille assembly
- Notched base rail supports

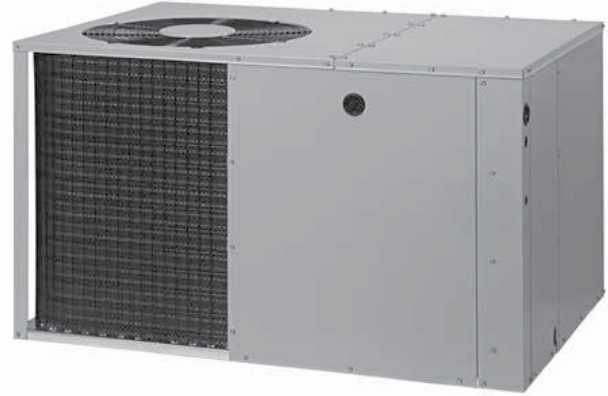

RESIDENTIAL REGISTERED WARRANTY

Effective on product manufactured after 4-1-19. Original homeowner only. Product must be registered within 60 days of installation date. (††)

- 10 year parts, 20 year heat exchanger, 10 year compressor, 1 year labor

RESIDENTIAL NON-REGISTERED WARRANTY

Effective on product manufactured after 4-1-19. Original homeowner only.

- 1 year parts, 20 year heat exchanger, 5 year compressor, 1 year labor

(†) IMPORTANT WARRANTY NOTE:

In order to be eligible for the full registered warranty and quality pledge, the consumer or Nortek dealer must register within **60** days of the later date of either installation or occupancy. If registration is not completed within 60 days, the warranty reverts to the non-registered (base standard) warranty.

For Contractors' Preferred Protection Plans, contact your R. A. Townsend Co. representative.

ID ORDER#	MODEL#	MILLER#	SEER	COOLING BTUH	NOM. TON.	CONNECTION DIA. SUPPLY	CONNECTION DIA. RETURN	DIMENSION W x D x H
WHILE SUPPLIES LAST								
696433	P7RE-030K	922413	14	28,400	2.5	12"	12"	35" x 49" x 22.2"

FOR SPECIFICATIONS, SEE PAGES 504.19
FOR BLOWER PERFORMANCE, SEE PAGE 504.20
FOR ELECTRICAL DATA, SEE PAGE 504.21
FOR ACCESSORIES, SEE PAGES 504.22-504.23
FOR ADDITIONAL INFORMATION, VISIT
THE NORTEK WEBSITE AT www.nortekhvac.com

MILLER PACKAGED A/C UNITS SPECIFICATIONS



MODEL IDENTIFICATION CODE

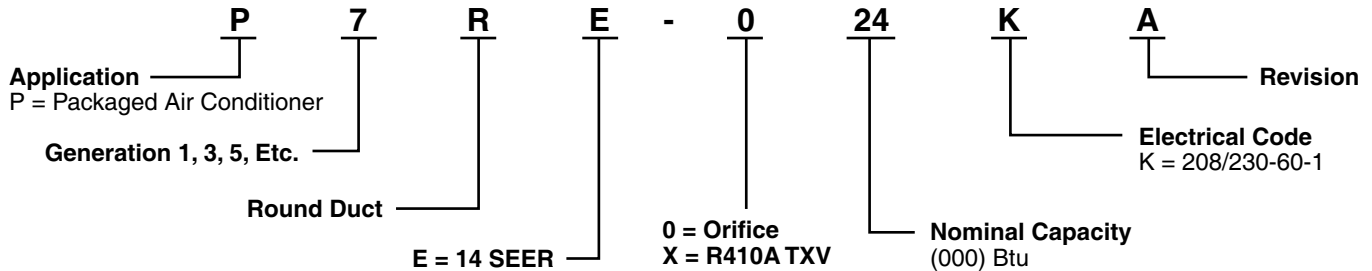

PHYSICAL SPECIFICATIONS

Model No. P7RE		018K	024K	030K	036K	042K	048K	X60KA
Performance Data	Cooling Btu/h	17800	23,800	28,400	35,000	40,500	47,000	56,000
	SEER	14	14	14	14	14	14	14
	EER	11	11	11	11	11	11	11
	Sound Ratings	73	73	73	76	76	78	78
Electrical Data	Volts-Cycles-Phase (1)	208/230-60-1						
	Operating Voltage Range	187-253	187 - 253	187 - 253	187 - 253	187 - 253	187 - 253	187 - 253
	Total Amps	11.5	13.1	14.7	21.5	24.8	28.7	32.8
	Delay Fuse - Max. (2)	20	20	25	40	45	50	60
	Min. Circuit Ampacity	13.2	15.2	17.2	25.7	29.3	34.2	38.9
Compressor Data	RLA	6.7	8.3	9.9	16.6	17.9	21.8	24.3
	LRA	42	50	69	79	112	117	144.2
Fan Motor	Amps		1	1	1.1	1.5	1.5	1.5
Blower Motor	Amps		3.8	3.8	3.8	5.4	5.4	7
R410A Refrigerant Charge	Oz.	55	55	58	58	57	70	73
Approximate Weight (lbs.)	Shipping	238	242	248	242	297	300	325
	Net Weight (lbs.)	226	230	236	230	283	286	309

(1) Operating Voltage Range: 187v min. - 253v max. Amperage and wire size based on refrigeration system only. See electrical data tables for supplemental electric heaters.

(2) HACR Type Circuit Breakers may be used.

Nortek Technical Specifications #640E-0818

P7RE PACKAGED ROOFTOPS
BLOWER PERFORMANCE



BLOWER PERFORMANCE

HEAT RISE DATA (Based on Nominal 10kw Electric Heat Kit)																	
UNIT	BLOWER SETTING	EXTERNAL STATIC PRESSURE DROP - INCHES WATER COLUMN															
		0.1		0.2		0.3		0.4		0.5		0.6		0.7		0.8	
		CFM	HEAT RISE	CFM	HEAT RISE	CFM	HEAT RISE	CFM	HEAT RISE	CFM	HEAT RISE	CFM	HEAT RISE	CFM	HEAT RISE	CFM	HEAT RISE
018K	Tap T1	609	52	541	58	522	61	450	70	390	81	333	95	-	-	-	-
	Tap T2*	729	43	690	46	651	49	599	53	542	58	475	67	421	75	357	88
	Tap T3	859	37	813	39	768	41	724	44	673	47	609	52	555	57	497	64
	Tap T4**	1123	28	1100	29	1065	30	1023	31	978	32	929	34	877	36	820	39
	Tap T5	1359	23	1320	24	1302	24	1280	25	1243	25	1205	26	1162	27	1112	28
024K	Tap T1*	950	33	823	38	881	36	832	38	788	40	722	44	655	48	593	53
	Tap T2**	1123	28	1100	29	1065	30	1023	31	978	32	929	34	877	36	820	39
	Tap T3	1189	27	1158	27	1141	28	1084	29	1047	30	1009	31	959	33	906	35
	Tap T4	1291	24	1246	25	1236	26	1195	26	1161	27	1120	28	1075	29	1031	31
	Tap T5	1359	23	1320	24	1302	24	1280	25	1243	25	1205	26	1162	27	1112	28
030K	Tap T1	965	33	910	35	870	36	800	39	720	44	665	48	615	51	560	56
	Tap T2**	1100	29	1050	30	1010	31	955	33	890	35	830	38	750	42	700	45
	Tap T3*	1160	27	1120	28	1080	29	1030	31	980	32	930	34	880	36	800	39
	Tap T4	1440	22	1400	23	1360	23	1320	24	1280	25	1220	26	1180	27	1120	28
	Tap T5	1560	20	1530	21	1490	21	1440	22	1400	23	1360	23	1310	24	1270	25
036K	Tap T1**	1215	26	1175	27	1130	28	1075	29	1020	31	970	33	900	35	840	38
	Tap T2	1313	24	1277	25	1236	26	1190	27	1153	27	1104	29	1051	30	992	32
	Tap T3	1460	22	1415	22	1385	23	1335	24	1275	25	1225	26	1170	27	1120	28
	Tap T4*	1502	21	1466	22	1437	22	1388	23	1345	23	1305	24	1251	25	1204	26
	Tap T5	1565	20	1525	21	1490	21	1450	22	1410	22	1370	23	1315	24	1270	25
042K	Tap T1	1375	23	1345	23	1310	24	1275	25	1240	25	1205	26	1160	27	1120	28
	Tap T2**	1470	21	1435	22	1400	23	1370	23	1335	24	1300	24	1260	25	1215	26
	Tap T3*	1600	20	1570	20	1535	21	1505	21	1470	21	1440	22	1400	23	1355	23
	Tap T4	1715	18	1680	19	1650	19	1620	20	1585	20	1545	20	1505	21	1470	21
	Tap T5	1895	17	1865	17	1830	17	1795	18	1760	18	1730	18	1695	19	1655	19
048K	Tap T1	1375	23	1345	23	1310	24	1275	25	1240	25	1205	26	1160	27	1120	28
	Tap T2**	1470	21	1435	22	1400	23	1370	23	1335	24	1300	24	1260	25	1215	26
	Tap T3	1600	20	1570	20	1535	21	1505	21	1470	21	1440	22	1400	23	1355	23
	Tap T4*	1715	18	1680	19	1650	19	1620	20	1585	20	1545	20	1505	21	1470	21
	Tap T5	1895	17	1865	17	1830	17	1795	18	1760	18	1730	18	1695	19	1655	19
X60KA	Tap T1**	1390	23	1350	23	1310	24	1270	25	1240	25	1205	26	1160	27	1120	28
	Tap T2	1540	21	1510	21	1480	21	1440	22	1410	22	1380	23	1340	24	1310	24
	Tap T3	1700	19	1670	19	1630	19	1600	20	1580	20	1540	21	1510	21	1480	21
	Tap T4*	1800	18	1762	18	1737	18	1705	19	1661	19	1630	19	1600	20	1565	20
	Tap T5	2080	15	2030	16	2020	16	1970	16	1940	16	1910	17	1870	17	1840	17

NOTES:

Temperature rises shaded gray are for reference only. These conditions are not recommended.

* Denotes factory set cooling speed

** Denotes factory set electric heating speed

Nortek Technical Specifications #640E-0818

MILLER

P7RE PACKAGED ROOFTOPS

ELECTRICAL DATA



ELECTRICAL DATA

Model	Heater kw	Single Circuit		Multiple Supply Circuit Option			
		MCA	MOP	Circuit A (Compressor, Blower & Fan)		Circuit B (Heater)	
				MCA	MOP	MCA	MOP
P7RE-018K	0	13.2	15.0	-	-	-	-
	5	29.8	30.0	-	-	-	-
	8	44.3	45.0	-	-	-	-
	10	54.8	60.0	-	-	-	-
	15	79.8	80.0	54.8	60	25	30
P7RE-024K	0	15.2	20.0	-	-	-	-
	5	29.8	30.0	-	-	-	-
	8	44.3	45.0	-	-	-	-
	10	54.8	60.0	-	-	-	-
	15	79.8	80.0	54.8	60	25	30
P7RE-030K	0	17.2	25.0	-	-	-	-
	5	29.8	30.0	-	-	-	-
	8	44.3	45.0	-	-	-	-
	10	54.8	60.0	-	-	-	-
	15	79.8	80	54.8	60	25	30
P7RE-036K	0	25.7	40.0	-	-	-	-
	5	29.8	40.0	-	-	-	-
	8	44.3	45.0	-	-	-	-
	10	54.8	60.0	-	-	-	-
	15	79.8	80	54.8	60	25	30
P7RE-042K	0	29.3	45.0	-	-	-	-
	5	31.9	45.0	-	-	-	-
	8	46.3	50.0	-	-	-	-
	10	56.8	60.0	-	-	-	-
	15	81.8	90	56.8	60	25	30
	20	106.8	110	56.8	60	50	60
P7RE-048K	0	34.2	50.0	-	-	-	-
	5	34.2	50.0	-	-	-	-
	8	46.3	50.0	-	-	-	-
	10	56.8	60.0	-	-	-	-
	15	81.8	90	56.8	60	25	30
	20	106.8	110	56.8	60	50	60
P7RE-X60KA	0	38.9	60.0	-	-	-	-
	5	38.9	60.0	-	-	-	-
	8	48.3	60.0	-	-	-	-
	10	58.8	60.0	-	-	-	-
	15	83.8	90	58.8	60	25	30
	20	108.8	110	58.8	60	50	60

Nortek Technical Specifications #640E-0818

MILLER

P7RE PACKAGED ROOFTOPS

ACCESSORIES



ID ORDER#	MODEL#	MILLER#	DESCRIPTION
524235 *	MHFK-12/14-SW	919455	DUCT FITTING KIT , single-wide 12" supply x 14" return
524236 *	MHFK-12/14-DW	919456	Same as above, but double-wide

* = SPECIAL ORDER ITEM

TYPICAL APPLICATIONS

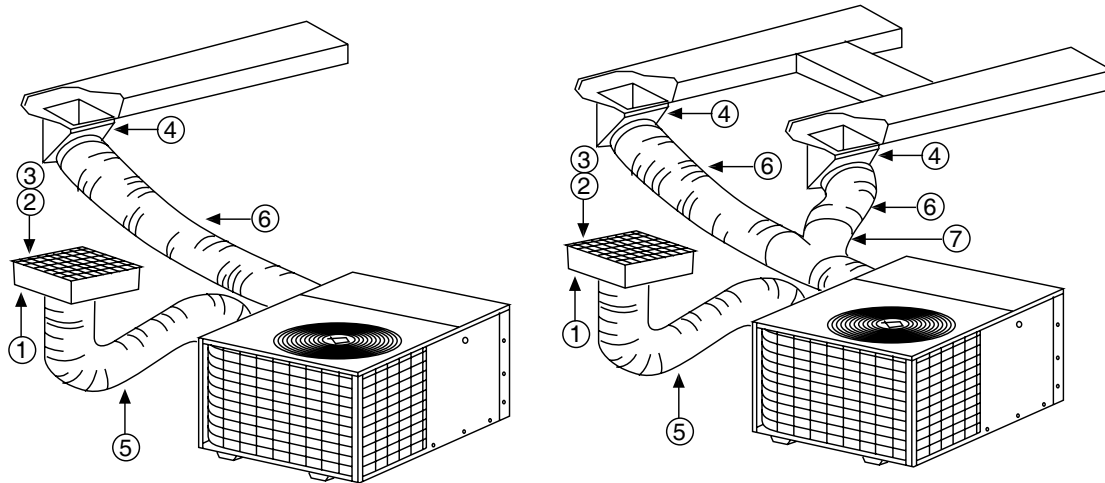

Single Wide Application

Double Wide Application

Ref. No.	Description
①	12" x 20" Return Air
②	16" x 20" Air Filter
③	12" x 20" Grille
④	Supply Damper
⑤	12" or 14" Diameter Flex Return Duct
⑥	12" Diameter Flex Supply Duct
⑦	12" x 12" x 12" "Y" Fitting

FOR ELECTRIC HEATER KITS, SEE PAGE 504.23

FOR ADDITIONAL INFORMATION, VISIT
THE NORTEK WEBSITE AT www.nortekhvac.com

MILLER

P7RE PACKAGED ROOFTOPS ACCESSORIES



ID ORDER#	MODEL#	MILLER#	DESCRIPTION
191364 *	H3HK005H-01C	917166C	ELECTRIC HEATER KIT (†), single stage, 240VAC, 5KW, <u>less circuit breaker</u> NOTE: ONE YEAR WARRANTY ON PARTS AND LABOR ON ELECTRIC HEATER KITS
191366 *	H3HK008H-01C	917167C	<i>Same as above</i> , but 8 K
191367 *	H3HK010H-01C	917168C	<i>Same as above</i> , but 10 KW
191368 *	H3HK015H-01C	917169C	<i>Same as above</i> , but 15 KW
191369 *	H3HK020H-01C	917170C	<i>Same as above</i> , but 20 KW
191370 *	H3HK015H-21C	917172C	<i>Same as above</i> , but <u>with (2) circuit breakers</u> and 15KW
NOTE FOR ELECTRIC HEATER KITS WITH CIRCUIT BREAKERS: Circuit breakers supplied with the H3HK electric heater kits are for short-circuit protection of the internal wiring and to serve as a unit disconnect. Circuit breakers supplied with the H3HK electric heater kits <u>do not</u> provide over-current protection of the supply wiring			
191371 *	H3HK020H-21C	917173C	<i>Same as above</i> , but 20 KW

* = SPECIAL ORDER ITEM

FOR ADDITIONAL INFORMATION, VISIT
THE NORTEK WEBSITE AT www.nortekhvac.com

Heater Application Matrix

Model Number P7RE	H3HK-005H-01C 917166C	H3HK-008H-01C 917167C	H3HK-010H-01C 917168C	H3HK-015H-01C 917169C	H3HK-020H-01C 917170C	H3HK-015H-21C 917172C	H3HK-020H-21C 917173C
018K	X	X	X	X	NA	X	NA
024K	X	X	X	X	NA	X	NA
030K	X	X	X	X(2)	NA	X	NA
036K	X	X	X	X(2)	NA	X	NA
042K	X	X	X	X(2)	X(2)	X	X
048K	X	X	X	X(2)	X(2)	X	X
X60KA	X	X	X	X(2)	X(2)	X	X

NA = Not Approved.
 () = Number of internal circuit breaker kits required.
 X = Branch circuit protection only.

MGC2SA & MGC2SK GAS FURNACES
80% - SINGLE STAGE - FIXED SPEED



HEATING AND COOLING PRODUCTS

- Single stage, fixed speed, upflow/horizontal or downflow
- FER compliant
- Multi-speed ECM direct drive blower
- Natural gas with LP conversion kit
- Low boy height
- Tubular primary heat exchanger
- 30-second blower delay
- 30-second post purge
- 60-second cooling cycle blower-off delay (TDR)
- Hot surface igniter with Smartlite technology
- Color-coded wire harness
- High static blowers
- Flexible category I venting system
- High efficiency blower kits
- Easy troubleshooting diagnostic lights
- Integrated control board
- 100% fired and tested



PLEASE NOTE:

Maytag products are supported and sold through an authorized dealer network. Please contact your sales representative or our office for details.

RESIDENTIAL REGISTERED & MATCHED WARRANTY

Effective on product manufactured after 4-1-19. Original homeowner only. Product must be registered within 60 days of installation date. (†)

- 12 year parts, lifetime heat exchanger (original owner), 90 day labor

RESIDENTIAL NON-REGISTERED WARRANTY

Effective on product manufactured after 4-1-19. Original homeowner only.

- 5 year parts, 20 year heat exchanger, 90 day labor

(†) IMPORTANT WARRANTY NOTE:

In order to be eligible for the full registered warranty and quality pledge, the consumer or Nortek dealer must register within 60 days of the later date of either installation or occupancy. If registration is not completed within 60 days, the warranty reverts to the non-registered (base standard) warranty.

For Contractors' Preferred Protection Plans, contact your R. A. Townsend Co. representative.

ID ORDER#	MODEL#	MBH CAPACITY		AFUE	HP	W x D x H	SUPPLY PLENUM OPENING
		IN	OUT				
UPFLOW/HORIZONTAL — NATURAL GAS							
* = SPECIAL ORDER ITEM							
740986	MGC2SA045C-T23A1P	45.0	36.0	80	1/2	14-1/4" x 28" x 34-1/2"	12-5/8" x 19"
740988	MGC2SA054C-T23A1P	52.0	42.0	80	1/2	14-1/4" x 28" x 34-1/2"	12-5/8" x 19"
740992	MGC2SA072C-T24B1P	70.0	56.0	80	3/4	17-1/2" x 28" x 34-1/2"	15-7/8" x 19"
740995	MGC2SA090C-T24B1P	90.0	72.0	80	3/4	17-1/2" x 28" x 34-1/2"	15-7/8" x 19"
740996 *	MGC2SA090C-T35C1P	90.0	72.0	80	1	21" x 28" x 34-1/2"	19-3/8" x 19"
740998	MGC2SA108C-T35C1P	108.0	86.4	80	1	21" x 28" x 34-1/2"	19-3/8" x 19"
741000 *	MGC2SA126C-T45D1P	126.0	100.8	80	1	24-1/2" x 28" x 34-1/2"	22-7/8" x 19"
DOWNFLOW — NATURAL GAS							
RETURN PLENUM OPENING							
741004	MGC2SK054C-T23A1P	52.0	42.0	80	1/2	14-1/4" x 28" x 34-1/2"	12-5/8" x 19"
741002	MGC2SK072C-T23B1P	70.0	56.0	80	3/4	17-1/2" x 28" x 34-1/2"	15-7/8" x 19"
741003 *	MGC2SK090C-T24B1P	90.0	72.0	80	3/4	17-1/2" x 28" x 34-1/2"	19-3/8" x 19"
741005 *	MGC2SK108C-T35C1P	108.0	86.4	80	1	21" x 28" x 34-1/2"	19-3/8" x 19"
741006 *	MGC2SK126C-T45D1P	126.0	100.8	80	1	24-1/2" x 28" x 34-1/2"	22-7/8" x 19"

FOR SPECIFICATIONS, SEE PAGE 505.1

FOR FURNACE ACCESSORIES, SEE PAGES 505.18

FOR ADDITIONAL INFORMATION, VISIT THE NORTEK WEBSITE AT www.nortekhvaca.com

MAYTAG

MGC2SA & MGC2SK GAS FURNACES

SPECIFICATIONS



HEATING AND COOLING PRODUCTS

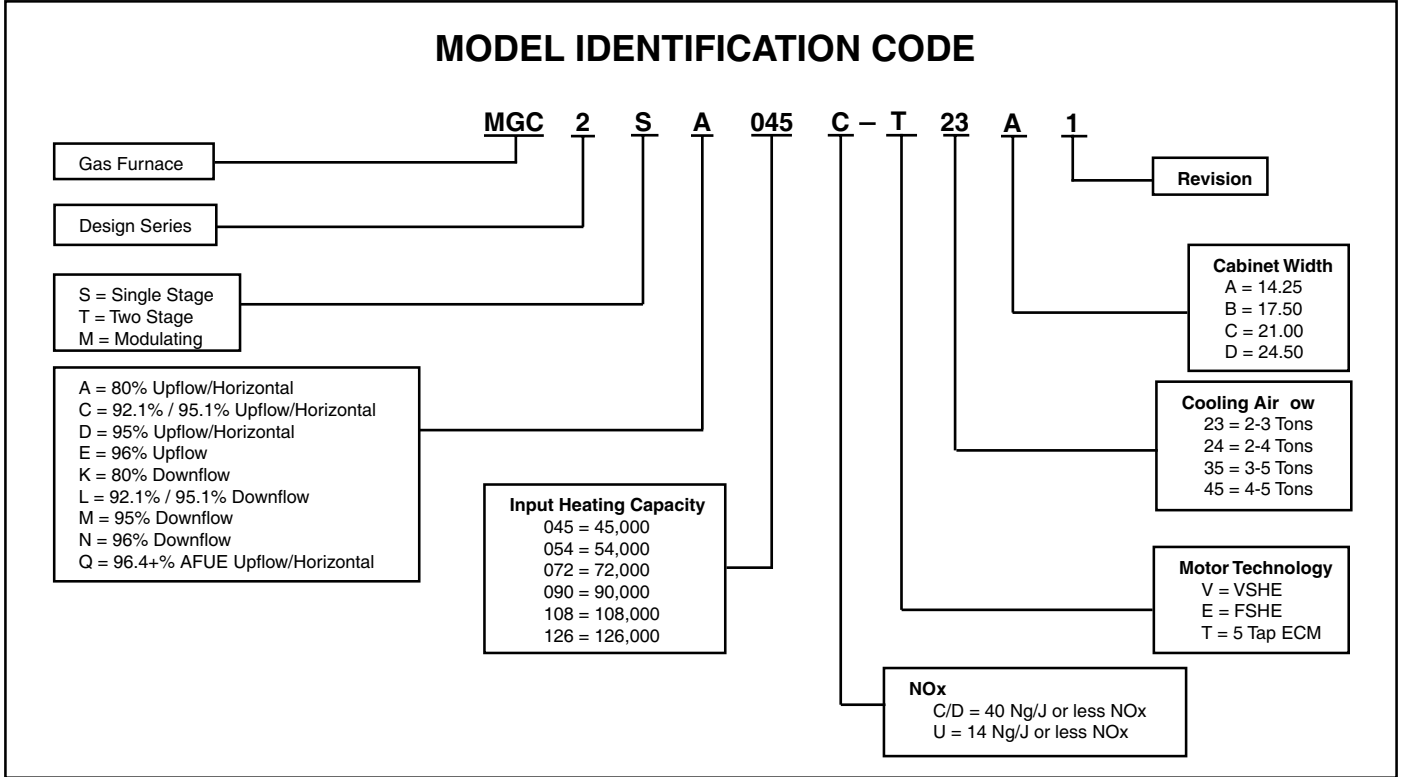

SPECIFICATIONS

MGC2SA MODEL NUMBERS	-045C-T23A1	-054C-T23A1	-072C-T24B1	-072C-T35C1	-090C-T24B1	-090C-T35C1	-108C-T35C1	-126C-T45D1
Input - Btuh (a)	45,000	52,000	70,000	70,000	90,000	Specifications not available on the Nortek website.	Specifications not available on the Nortek website.	Specifications not available on the Nortek website.
Heating Capacity - Btuh	36,000	42,000	56,000	56,000	72,000			
AFUE	80.0	80.0	80.0	80.0	80.0			
Motor H.P. - Speed - Type	1/2 - 5 - ECM	1/2 - 5 - ECM	3/4 - 5 - ECM	1 - 5 - ECM	3/4 - 5 - ECM			
Motor FLA	6.4	6.4	8.8	11.5	8.8			
Rated Ext. SP - In. W.C.	0.5	0.5	0.5	0.5	0.5			
Temperature Rise Range - °F	30-60	30-60	35-65	35-65	35-65			
Shipping Weights	95 lbs	95 lbs	110 lbs	115 lbs	115 lbs			

MGC2SK MODEL NUMBERS	-054C-T23A1	-072C-T23B1	-072C-T24B1	-090C-T24B1	-108C-T35C1	-126C-T45D1
Input - Btuh (a)	Specifications not available on the Nortek website.	Specifications not available on the Nortek website.	72,000	90,000	Specifications not available on the Nortek website.	Specifications not available on the Nortek website.
Heating Capacity - Btuh				72,000		
AFUE			80.0	80.0		
Motor H.P. - Speed - Type			3/4 - 5 - ECM	3/4 - 5 - ECM		
Motor FLA			8.8	8.8		
Rated Ext. SP - In. W.C.			0.5	0.5		
Temperature Rise Range - °F			35-65	35-65		
Shipping Weights	110 lb	115 lb				

Note: All models are 115V, 60 Hz. Gas Connections are 1/2" N.P.T. AFUE = Annual Fuel Utilization Efficiency
 (a) Ratings to 2,000 ft. Over 2,000 ft. reduce 4% for each 1,000 ft. above sea level.

MGC2SD GAS FURNACES
95% - SINGLE STAGE - FIXED SPEED



- Single stage, fixed speed, upflow only
- FER compliant
- Multi-speed ECM direct drive blower
- Natural gas with LP conversion kit
- Low boy height
- Tubular primary heat exchanger
- 30-second blower delay
- 30-second post purge
- 60-second cooling cycle blower-off delay (TDR)
- Hot surface igniter with Smartlite technology
- Color-coded wire harness
- High static blowers
- Flexible category IV venting system
- High efficiency blower kits
- Sealed vestibule
- Easy troubleshooting diagnostic lights
- Integrated control board
- 100% fired and tested



PLEASE NOTE:

Maytag products are supported and sold through an authorized dealer network. Please contact your sales representative or our office for details.

RESIDENTIAL REGISTERED & MATCHED WARRANTY

Effective on product manufactured after 4-1-19. Original homeowner only. Product must be registered within 60 days of installation date. (†)

- 12 year parts, lifetime heat exchanger (original owner), 90 day labor

RESIDENTIAL NON-REGISTERED WARRANTY

Effective on product manufactured after 4-1-19. Original homeowner only.

- 5 year parts, 20 year heat exchanger, 90 day labor

For Contractors' Preferred Protection Plans, contact your R. A. Townsend Co. representative.

(†) IMPORTANT WARRANTY NOTE:

In order to be eligible for the full registered warranty and quality pledge, the consumer or Nortek dealer must register within 60 days of the later date of either installation or occupancy. If registration is not completed within 60 days, the warranty reverts to the non-registered (base standard) warranty.

ID ORDER#	MODEL#	MBH CAPACITY IN	MBH CAPACITY OUT	AFUE	HP	W x D x H	SUPPLY PLENUM OPENING
UPFLOW ONLY — NATURAL GAS							* = SPECIAL ORDER ITEM
741007 *	MGC2SD038D-T24B1P	38.0	36.1	95.0	1/2	17-1/2" x 28" x 34-1/2"	15-7/8" x 19"
741008	MGC2SD054D-T24B1P	54.0	51.3	95.0	1/2	17-1/2" x 28" x 34-1/2"	15-7/8" x 19"
741009	MGC2SD072D-T35C1P	72.0	68.4	95.0	1/2	21" x 28" x 34-1/2"	19-3/8" x 19"
741010	MGC2SD090D-T35C1P	90.0	85.5	95.0	1	21" x 28" x 34-1/2"	19-3/8" x 19"
741012	MGC2SD108D-T45D1P	108.0	102.6	95.0	1	24-1/2" x 28" x 34-1/2"	22-7/8" x 19"
741013	MGC2SD120D-T45D1P	120.0	114.0	95.0	1	24-1/2" x 28" x 34-1/2"	22-7/8" x 19"

FOR SPECIFICATIONS, SEE PAGE 505.3

FOR FURNACE ACCESSORIES, SEE PAGES 505.18

FOR ADDITIONAL INFORMATION, VISIT
THE NORTEK WEBSITE AT www.nortekhvac.com

MAYTAG

MGC2SD GAS FURNACES SPECIFICATIONS



HEATING AND COOLING PRODUCTS

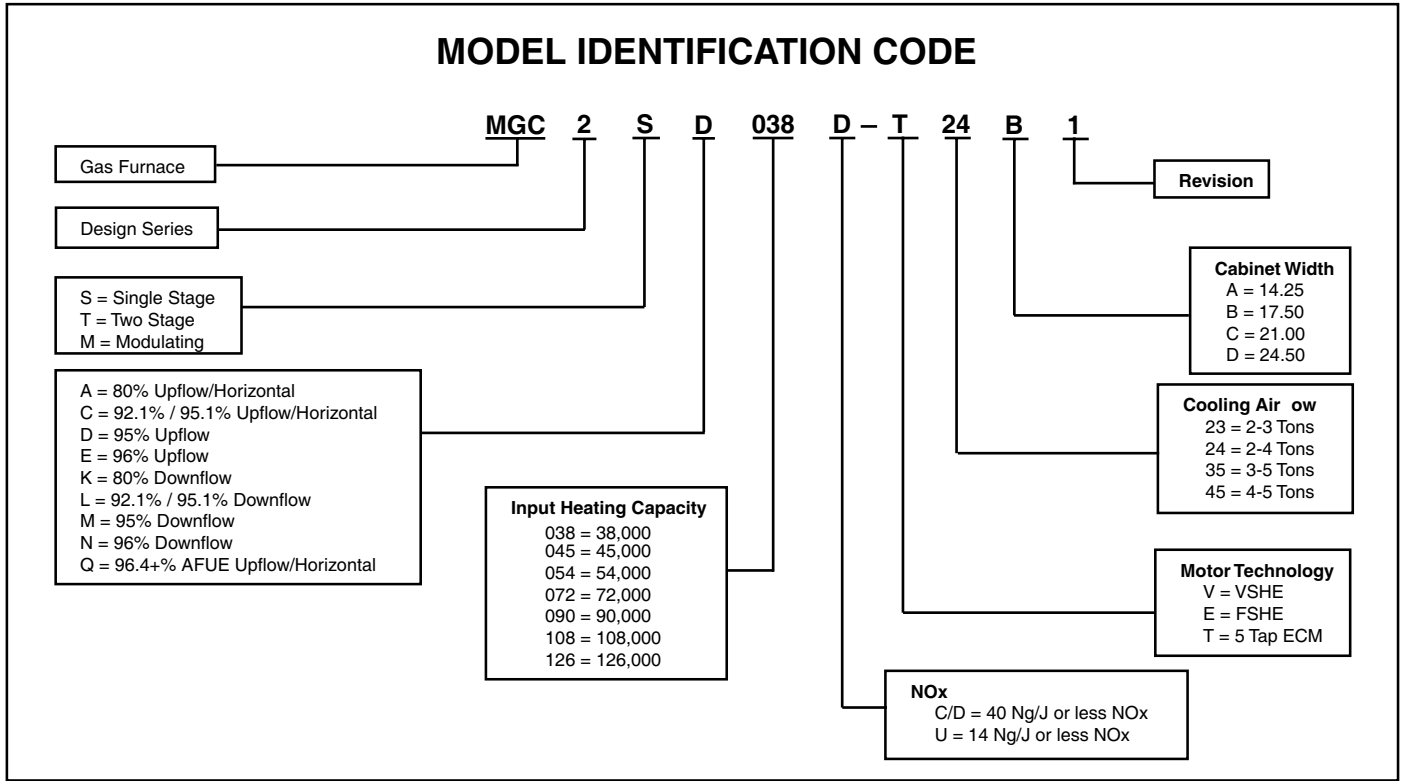

SPECIFICATIONS

MGC2SD MODEL NUMBERS	038D-T24B1	054D-T24B1	072D-T35C1	090D-T35C1	108D-T45D1	120D-T45D1
Input - Btuh (a)	38,000	54,000	72,000	85,000	108,000	Specifications not available on the Nortek website.
Heating Capacity - Btuh	36,000	51,000	68,000	81,000	103,000	
AFUE	95	95	95	95	95	
Blower D x W	10 x 8	11 x 8	10 x 10	11 x 10	11 x 10	
Motor H.P. - Speed - Type	3/4 - 5 - ECM	3/4 - 5 - ECM	3/4 - 5 - ECM	1 - 5 - ECM	1 - 5 - ECM	
Motor FLA	8.8	8.8	8.8	11.5	11.5	
Rated Ext. SP - In. W.C.	0.5	0.5	0.5	0.5	0.5	
Temperature Rise Range - °F	25-55	30-60	35-65	35-65	35-65	
Shipping Weights	100lbs	120lbs	130lbs	135lbs	155lbs	

Note: All models are 115V, 60 Hz. Gas Connections are 1/2" N.P.T. AFUE = Annual Fuel Utilization Efficiency
 (a) Ratings to 2,000 ft. Over 2,000 ft. reduce 4% for each 1,000 ft. above sea level.

PGC2TC GAS FURNACES

95% - TWO STAGE - VARIABLE SPEED



HEATING AND COOLING PRODUCTS

- Two stage, variable speed, upflow/horizontal
- FER compliant
- Multi-speed ECM direct drive blower
- Natural gas with LP conversion kit
- Low boy height
- Tubular primary heat exchanger
- 30-second blower delay
- 30-second post purge
- 60-second cooling cycle blower-off delay (TDR)
- Hot surface igniter with Smartlite technology
- Color-coded wire harness
- High static blowers
- Flexible category IV venting system
- Easy troubleshooting diagnostic lights
- Sealed vestibule
- Integrated control board
- 100% fired and tested



PLEASE NOTE:

Maytag products are supported and sold through an authorized dealer network. Please contact your sales representative or our office for details.

RESIDENTIAL REGISTERED & MATCHED WARRANTY

Effective on product manufactured after 4-1-19. Original homeowner only. Product must be registered within 60 days of installation date. (†)

- 12 year parts, lifetime heat exchanger (original owner), 90 day labor

RESIDENTIAL NON-REGISTERED WARRANTY

Effective on product manufactured after 4-1-19. Original homeowner only.

- 5 year parts, 20 year heat exchanger, 90 day labor

For Contractors' Preferred Protection Plans, contact your R. A. Townsend Co. representative.

(†) IMPORTANT WARRANTY NOTE:

In order to be eligible for the full registered warranty and quality pledge, the consumer or Nortek dealer must register within 60 days of the later date of either installation or occupancy. If registration is not completed within 60 days, the warranty reverts to the non-registered (base standard) warranty.

ID ORDER#	MODEL#	MBH CAPACITY IN	MBH CAPACITY OUT	AFUE	HP	W x D x H	SUPPLY PLENUM OPENING
UPFLOW/HORIZONTAL — NATURAL GAS							
741035	PGC2TC060D-V24B1P	60.0/39.0	57.0/37.0	95.0	3/4	17-1/2" x 28" x 34-1/2"	15-7/8" x 19"
741036	PGC2TC080D-V35C1P	80.0/52.0	76.0/49.0	95.0	1	21" x 28" x 34-1/2"	19-3/8" x 19"
741037	PGC2TC100D-V35C1P	100.0/65.0	95.0/62.0	95.0	1	21" x 28" x 34-1/2"	19-3/8" x 19"
741040	PGC2TC120D-V45D1P	120.0/78.0	114.0/74.0	95.0	1	24-1/2" x 28" x 34-1/2"	22-7/8" x 19"

FOR SPECIFICATIONS, SEE PAGE 505.5

FOR FURNACE ACCESSORIES, SEE PAGES 505.18

FOR ADDITIONAL INFORMATION, VISIT THE NORTEK WEBSITE AT www.nortekhvac.com

MAYTAG PGC2TC GAS FURNACES SPECIFICATIONS

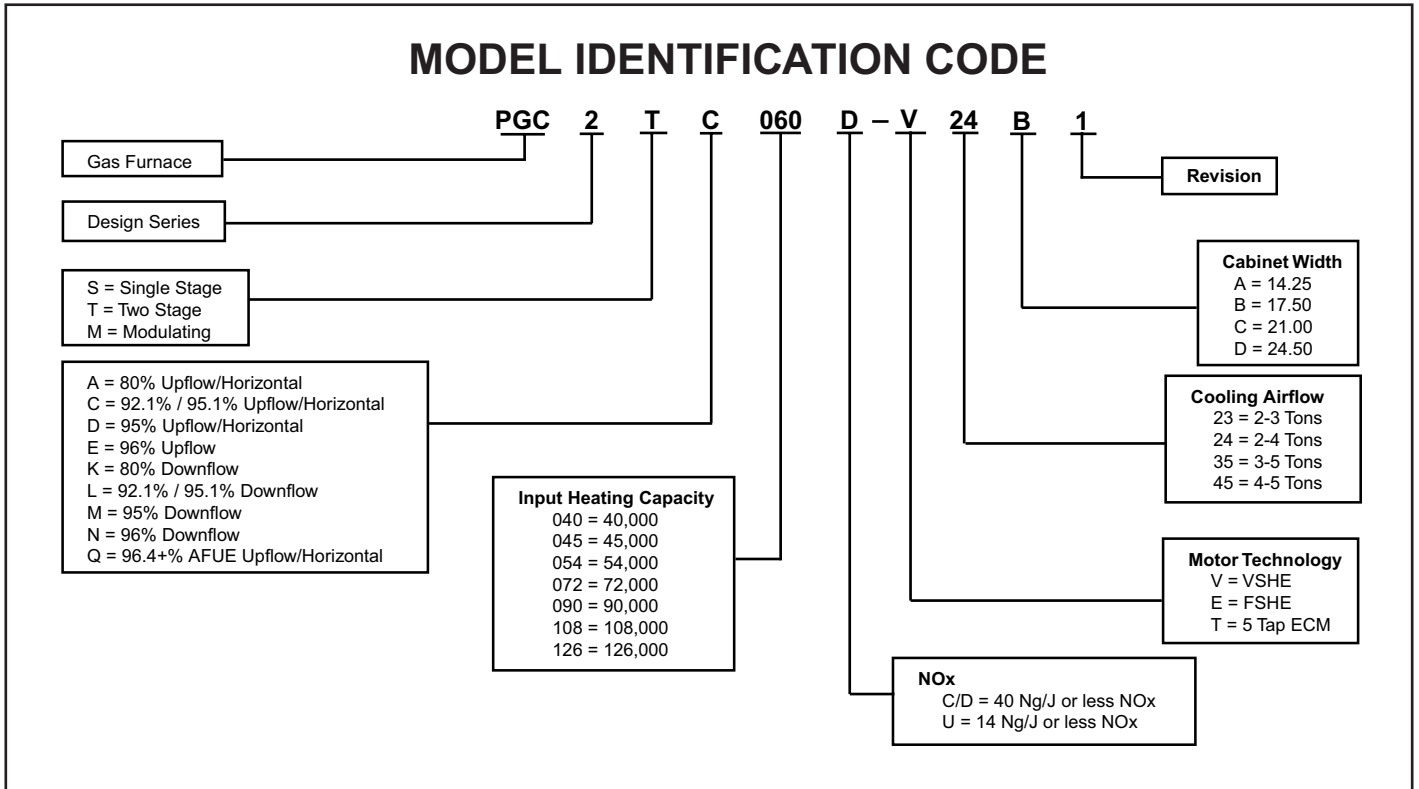

SPECIFICATIONS

PGC2TC MODEL NUMBERS	-060D-V24B1	-080D-V35C1	-100D-V35C1	-120D-V45D1
Input - Btuh (a)	60,000 / 39,000	80,000 / 52,000	100,000 / 65,000	Specifications not available on the Nortek website.
Heating Capacity - BtuH	57,000 / 37,000	76,000 / 49,000	95,000 / 62,000	
AFUE	95.0	95.0	95.0	
Motor H.P. - Speed - Type	3/4 - Variable	1 - Variable	1 - Variable	
Motor FLA	8.8	11.5	11.5	
Rated Ext. SP - In. W.C.	0.50	0.50	0.50	
Temperature Rise Range - F	30-60	35-65	35-65	
Shipping Weights	120 lb	140 lb	145 lb	
SKU	1025924P	1025925P	1025926P	

Note:
All models are 115V, 60 Hz. Gas Connections are 1/2" N.P.T. AFUE = Annual Fuel Utilization Efficiency
(a) Ratings to 2,000 ft. Over 2,000 ft. reduce 4% for each 1,000 ft. above sea level.

PGC2TE GAS FURNACES
96% - TWO STAGE - FIXED SPEED



HEATING AND COOLING PRODUCTS

- Two stage, fixed speed, upflow only
- FER compliant
- Multi-speed ECM direct drive blower
- Natural gas with LP conversion kit
- Low boy height
- Tubular primary heat exchanger
- 30-second blower delay
- 30-second post purge
- 60-second cooling cycle blower-off delay (TDR)
- Hot surface igniter with Smartlite technology
- Color-coded wire harness
- High static blowers
- Flexible category IV venting system
- Easy troubleshooting diagnostic lights
- Sealed vestibule
- Integrated control board
- 100% fired and tested



PLEASE NOTE:

Maytag products are supported and sold through an authorized dealer network. Please contact your sales representative or our office for details.

RESIDENTIAL REGISTERED & MATCHED WARRANTY
Effective on product manufactured after 4-1-19. Original homeowner only. Product must be registered within 60 days of installation date. (†)

- 12 year parts, lifetime heat exchanger (original owner), 90 day labor

RESIDENTIAL NON-REGISTERED WARRANTY
Effective on product manufactured after 4-1-19. Original homeowner only.

- 5 year parts, 20 year heat exchanger, 90 day labor

For Contractors' Preferred Protection Plans, contact your R. A. Townsend Co. representative.

(†) IMPORTANT WARRANTY NOTE:

In order to be eligible for the full registered warranty and quality pledge, the consumer or Nortek dealer must register within 60 days of the later date of either installation or occupancy. If registration is not completed within 60 days, the warranty reverts to the non-registered (base standard) warranty.

ID ORDER#	MODEL#	MBH CAPACITY IN	MBH CAPACITY OUT	AFUE	HP	W x D x H	SUPPLY PLENUM OPENING
UPFLOW ONLY — NATURAL GAS							
756704	PGC2TE035D-E23A1P	35.0/23.0	33.0/22.0	96.0	1/2	14-1/4" x 28" x 34-1/2"	12-5/8" x 19"
741049	PGC2TE060D-E24B1P	60.0/39.0	58.0/37.0	96.0	3/4	17-1/2" x 28" x 34-1/2"	15-7/8" x 19"
741050	PGC2TE080D-E35C1P	80.0/52.0	77.0/50.0	96.0	1	21" x 28" x 34-1/2"	19-3/8" x 19"
741051	PGC2TE100D-E35C1P	100.0/65.0	96.0/62.0	96.0	1	21" x 28" x 34-1/2"	19-3/8" x 19"
741052	PGC2TE115D-E45D1P	115.0/74.75	110.0/72.0	96.0	1	24-1/2" x 28" x 34-1/2"	22-7/8" x 19"

FOR SPECIFICATIONS, SEE PAGE 505.7

FOR FURNACE ACCESSORIES, SEE PAGES 505.18

FOR ADDITIONAL INFORMATION, VISIT THE NORTEK WEBSITE AT www.nortekhvac.com

MAYTAG

PGC2TE GAS FURNACES

SPECIFICATIONS



HEATING AND COOLING PRODUCTS

MODEL IDENTIFICATION CODE

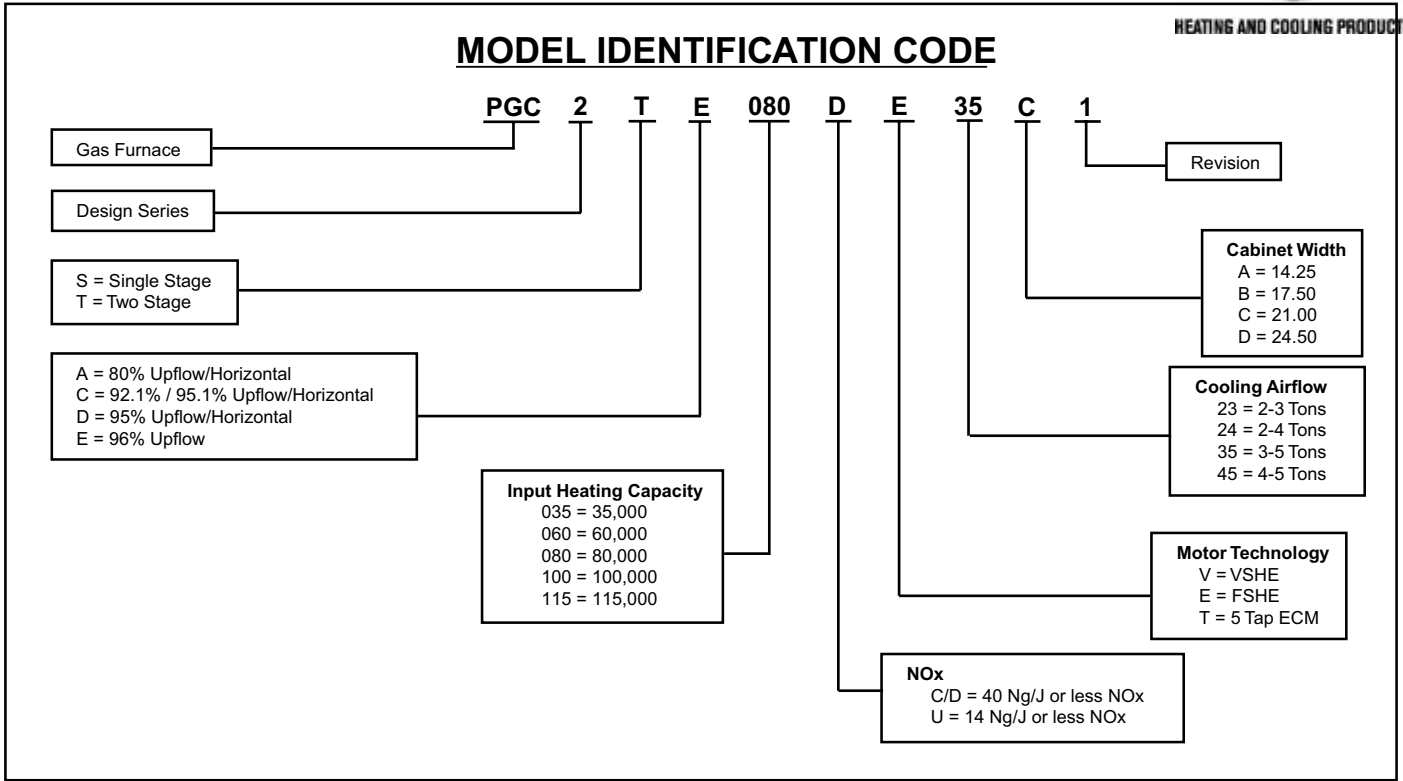

SPECIFICATIONS

PGC2TE MODEL NUMBERS:	035DE23A1	060DE24B1	080DE35C1	100DE35C1	115DE45D1
Input - Btuh (a)	35000 / 23000	60000 / 39000	80000 / 52000	100000 / 65000	115000 / 74750
Heating Capacity - BtuH	33000 / 22000	58000 / 37000	77000 / 50000	96000 / 62000	110000 / 72000
AFUE	96.0	96.0	96.0	96.0	96.0
Motor H.P. - Speed - Type	1/2 - BLDC	3/4 - BLDC	1 - BLDC	1 - BLDC	1 - BLDC
Motor FLA	6.9	8.8	11.5	11.5	11.5
Rated Ext. SP - In. W.C.	0.50	0.50	0.50	0.50	0.50
Temperature Rise Range - F	30-60	30-60	30-60	35-65	40-70
Shipping Weights	101 lb	120 lb	130 lb	135 lb	145 lb
SKU	1037159P	1025958P	1025959P	1025960P	1025961P

Note:

All models are 115V, 60 Hz. Gas Connections are 1/2" N.P.T. AFUE = Annual Fuel Utilization Efficiency
 (a) Ratings to 2,000 ft. Over 2,000 ft. reduce 4% for each 1,000 ft. above sea level.

PGC2TE & PGC2TN GAS FURNACES
96% - TWO STAGE - VARIABLE SPEED



HEATING AND COOLING PRODUCTS

- Two stage, variable speed, upflow or downflow only
- FER compliant
- Multi-speed ECM direct drive blower
- Natural gas with LP conversion kit
- Low boy height
- Tubular primary heat exchanger
- 30-second blower delay
- 30-second post purge
- 60-second cooling cycle blower-off delay (TDR)
- Hot surface igniter with Smartlite technology
- Color-coded wire harness
- High static blowers
- Flexible category IV venting system
- Easy troubleshooting diagnostic lights
- Integrated control board
- 100% fired and tested



PLEASE NOTE:

Maytag products are supported and sold through an authorized dealer network. Please contact your sales representative or our office for details.

(†) IMPORTANT WARRANTY NOTE:

In order to be eligible for the full registered warranty and quality pledge, the consumer or Nortek dealer must register within 60 days of the later date of either installation or occupancy. If registration is not completed within 60 days, the warranty reverts to the non-registered (base standard) warranty.

VENTING NOTE:

If venting out the right or left side, a #664969 condensate drain and a #71420 2" PVC vent tee are required. These accessories are not required if venting out of the top of the furnace.

RESIDENTIAL REGISTERED & MATCHED WARRANTY

Effective on product manufactured after 4-1-19. Original homeowner only. Product must be registered within 60 days of installation date. (†)

- 12 year parts, lifetime heat exchanger (original owner), 90 day labor

RESIDENTIAL NON-REGISTERED WARRANTY

Effective on product manufactured after 4-1-19. Original homeowner only.

- 5 year parts, 20 year heat exchanger, 90 day labor

For Contractors' Preferred Protection Plans, your R. A. Townsend Co. representative.

ID ORDER#	MODEL#	MBH CAPACITY IN	MBH CAPACITY OUT	AFUE	HP	W x D x H	SUPPLY PLENUM OPENING	RETURN PLENUM OPENING
UPFLOW ONLY — NATURAL GAS								
741043	PGC2TE060D-V24B1P	60.0/39.0	58.0/37.0	96.0	3/4	17-1/2" x 28" x 34-1/2"	15-7/8" x 19"	
741053	PGC2TE080D-V35C1P	80.0/52.0	77.0/50.0	96.0	1	21" x 28" x 34-1/2"	19-3/8" x 19"	
741044	PGC2TE100D-V35C1P	100.0/65.0	96.0/62.0	96.0	1	21" x 28" x 34-1/2"	19-3/8" x 19"	
741046	PGC2TE115D-V45D1P	115.0/75.0	110.0/72.0	96.0	1	24-1/2" x 28" x 34-1/2"	22-7/8" x 19"	
DOWNFLOW ONLY — NATURAL GAS								
741058	PGC2TN060D-V24B1P	60.0/39.0	58.0/37.0	96.0	3/4	17-1/2" x 28" x 34-1/2"	15-7/8" x 19"	
741059	PGC2TN080D-V35C1P	80.0/52.0	77.0/50.0	96.0	1	21" x 28" x 34-1/2"	19-3/8" x 19"	
741060	PGC2TN100D-V35C1P	100.0/65.0	96.0/62.0	96.0	1	21" x 28" x 34-1/2"	19-3/8" x 19"	
741061	PGC2TN115D-V45D1P	115.0/75.0	110.0/72.0	96.0	1	24-1/2" x 28" x 34-1/2"	22-7/8" x 19"	

FOR SPECIFICATIONS, SEE PAGE 505.9

FOR FURNACE ACCESSORIES, SEE PAGES 505.18

FOR ADDITIONAL INFORMATION, VISIT THE NORTEK WEBSITE AT www.nortekhvac.com

MAYTAG

PGC2TE & PGC2TN GAS FURNACES

SPECIFICATIONS



HEATING AND COOLING PRODUCTS

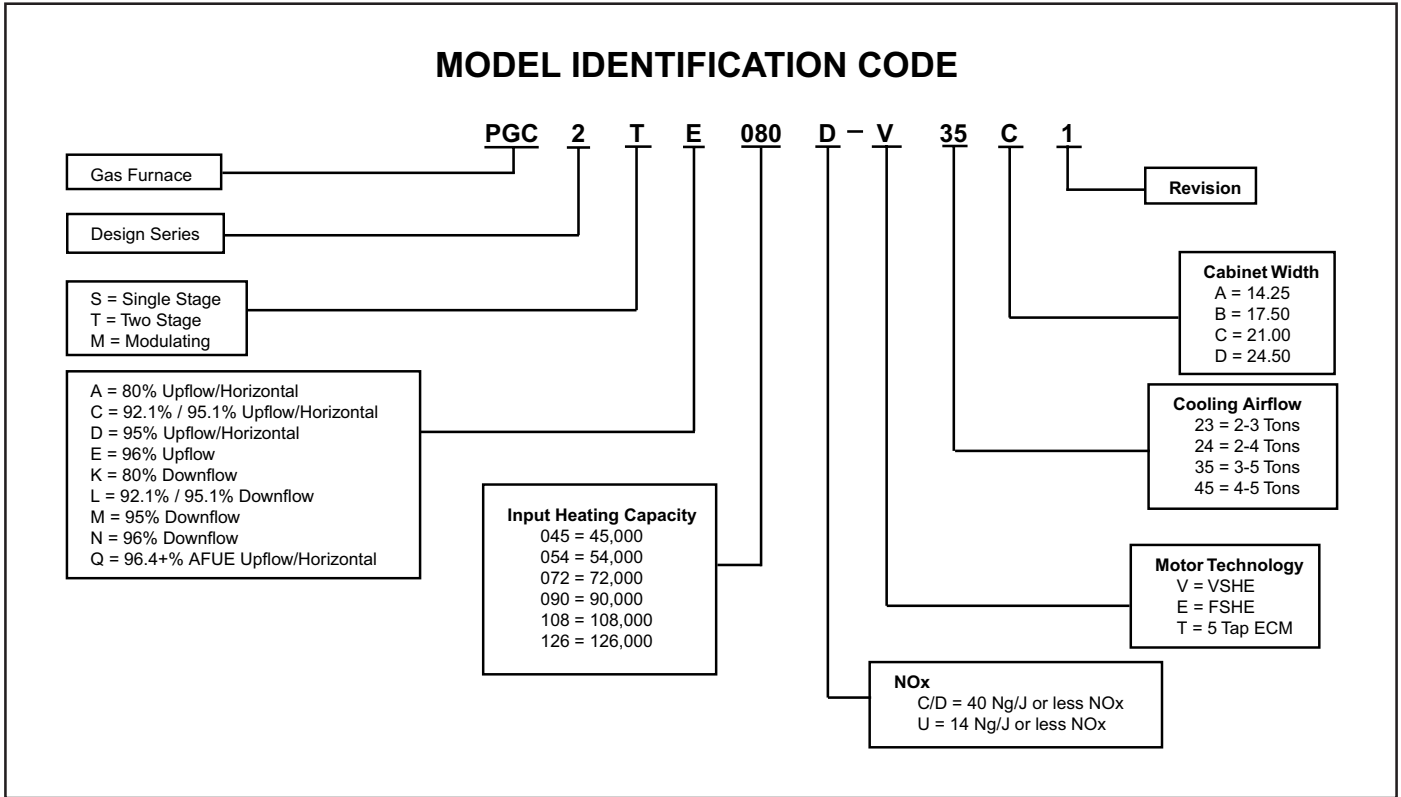

SPECIFICATIONS

PGC2TE MODEL NUMBERS	060D-V24B1	080D-V35C1	100D-V35C1	115D-V45D1
Input - Btuh (a)	Specifications not available on the Nortek website.	80,000 / 52,000	Specifications not available on the Nortek website.	Specifications not available on the Nortek website.
Heating Capacity - BtuH		77,000 / 50,000		
AFUE		96.0		
Motor H.P. - Speed - Type		1 - Variable		
Motor FLA		11.5		
Rated Ext. SP - In. W.C.		0.50		
Temperature Rise Range - F		35-65		
Shipping Weights		130 lb		
SKU		1025967P		

PGC2TN MODEL NUMBERS	060D-V24B1	080D-V35C1	100D-V35C1	115D-V45D1
Input - Btuh (a)	60,000 / 39,000	80,000 / 52,000	100,000 / 65,000	115,000 / 75,000
Heating Capacity - BtuH	58,000 / 37,000	77,000 / 50,000	96,000 / 62,000	110,000 / 72,000
AFUE	96.0	96.0	96.0	96.0
Motor H.P. - Speed - Type	3/4 - Variable	1 - Variable	1 - Variable	1 - Variable
Motor FLA	8.8	11.5	11.5	11.5
Rated Ext. SP - In. W.C.	0.50	0.50	0.50	0.50
Temperature Rise Range - F	30-60	35-65	35-65	40-70
Shipping Weights	120 lb	130 lb	135 lb	145 lb
SKU	1025970P	1025971P	1025972P	1025973P

Note:
All models are 115V, 60 Hz. Gas Connections are 1/2" N.P.T. AFUE = Annual Fuel Utilization Efficiency
(a) Ratings to 2,000 ft. Over 2,000 ft. reduce 4% for each 1,000 ft. above sea level.

SEPTEMBER 2024

Line #5184

MAYTAG

505.10

CSA1BD CONDENSERS

13 SEER - 1.5 TO 5 TON CAPACITY



HEATING AND COOLING PRODUCTS

- 13 SEER, R-410A
- Single phase
- Quiet Plus compressor sound blanket and Swept Wing fan blade
- Galvanized steel with polyester urethane coat finish
- Permanently lubricated PSC motor
- Removable top grille assembly
- High pressure switch with Smartlite technology
- Liquid line filter drier (included, field installed)
- One piece top/orifice
- Easy compressor and control access
- Composite base pan
- Micro-channel coils
- Servicer-friendly jacket



PLEASE NOTE:

Maytag products are supported and sold through an authorized dealer network. Please contact your sales representative or our office for details.

RESIDENTIAL REGISTERED & MATCHED WARRANTY

Effective on product manufactured after 4-1-19. Original homeowner only. Product must be registered within 60 days of installation date. (†)

- 12 year parts, 12 year compressor, 90 day labor

RESIDENTIAL NON-REGISTERED WARRANTY

Effective on product manufactured after 4-1-19. Original homeowner only.

- 5 year parts, 5 year compressor, 90 day labor

For Contractors' Preferred Protection Plans, contact your R. A. Townsend Co. representative.

(†) IMPORTANT WARRANTY NOTE:

In order to be eligible for the full registered warranty and quality pledge, the consumer or Nortek dealer must register within 60 days of the later date of either installation or occupancy. If registration is not completed within 60 days, the warranty reverts to the non-registered (base standard) warranty.

ID ORDER#	MODEL#	SEER	NOM. TON	NOMINAL COOLING (††) CAPACITY BTUH	DIMENSIONS W x D x H
738195	CSA1BD4M1SN24KA	13	2.0	24,000	23-3/4" x 23-3/4" x 24-1/2"
738196	CSA1BD4M1SN30K	13	2.5	30,000	23-3/4" x 23-3/4" x 28-1/2"

WHILE SUPPLIES LAST

FOR SPECIFICATIONS, SEE PAGE 505.11

FOR A/C ACCESSORIES, SEE PAGES 505.19

FOR ADDITIONAL INFORMATION, VISIT THE NORTEK WEBSITE AT www.nortekhv.com

OUTPUT NOTE (††): Output capacity may vary slightly. See Nortek website (www.nortekhv.com) or current AHRI directory (www.ahridirectory.com) for certified combinations and ratings.

MAYTAG CSA1BD CONDENSERS SPECIFICATIONS

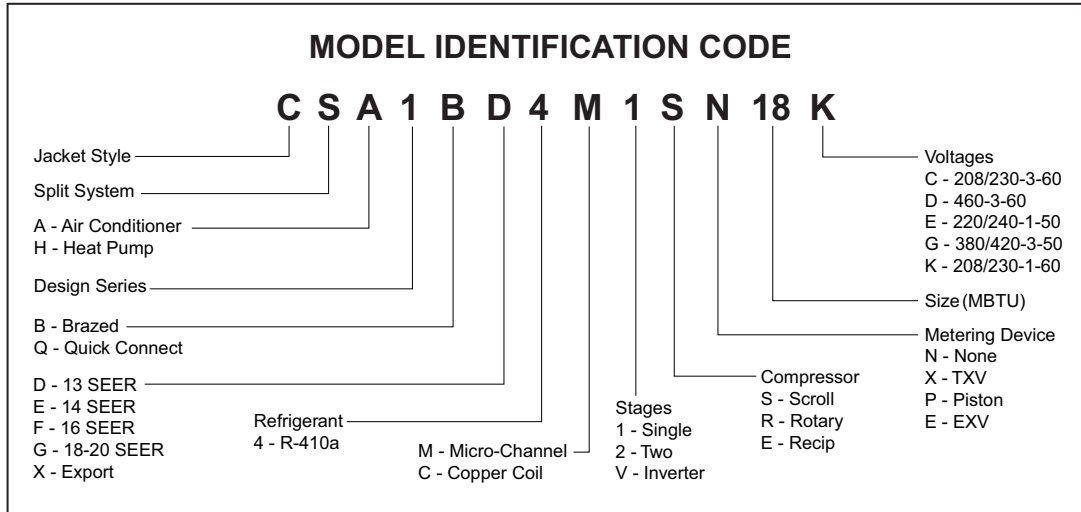

PHYSICAL AND ELECTRICAL SPECIFICATIONS / OUTDOOR UNITS

13 SEER — High Efficiency

Model Number CSA1BD		18K	24K	30K	36K	42K	48K	60K	
Electrical Data	Volts-Cycles-Phase (1)	208/230-60-1	208/230-60-1	208/230-60-1	208/230-60-1	208/230-60-1	208/230-60-1	208/230-60-1	
	Total Amps	9.3	13.5	14.8	18.0	19.4	23.2	27.8	
	Delay Fuse Max. (2)	20	25	30	35	40	50	60	
	Min. Circuit Ampacity	11.6	16.7	18.3	22.2	23.9	28.7	34.4	
Component Data	Fan Motor	Type	PSC	PSC	PSC	PSC	PSC	PSC	
		Amps	0.35	0.7	0.7	1.4	1.5	1.5	1.5
		HP	0.05	0.1	0.1	0.25	0.25	0.25	0.25
	Compressor Data	RLA	9.0	12.8	14.1	16.6	17.9	21.8	26.4
		LRA	48.0	58.3	73.0	79.0	112.0	117.0	134.0
Refrigerant suction line O.D. NOTE: Liquid line is 3/8" O.D. for entire length.	0-24 ft.	3/4"	3/4"	3/4"	3/4"	7/8"	7/8"	7/8"	
	25-39 ft.	3/4"	3/4"	3/4"	7/8" (3)	7/8"	7/8"	1-1/8" (4)	
	40-75 ft.	3/4"	3/4"	3/4"	7/8" (3)	7/8"	7/8"	1-1/8" (4)	
Approximate Weight (lbs.)	Net	141	161	145	144	210	210	220	
	Ship	150	170	154	153	220	220	231	
Sound Rating db		67	67	67	70	69	69	69	

(1) Operating Voltage Range: 187v min. - 253v max.

(2) HACR Type Circuit Breakers may be used.

(3) Requires 7/8" to 3/4" reducer from line to unit.

(4) Requires 7/8" to 1-1/8" reducer from line to unit.

Note: Additional charge fro line sets above 15 feet.

Values based on suction line as follows with 3/8" liquid line.

a) 3/4" = 0.6 oz. per additional foot.

b) 7/8" = 0.7 oz. per additional foot.

c) 1-1/8" = 0.8 oz. per additional foot.

(5) For additional charging instructions please refer to the QRD.

SEPTEMBER 2024

Line #5184

MAYTAG

505.12

PSA1BE CONDENSERS

14 SEER - 1.5 TO 5 TON CAPACITY



HEATING AND COOLING PRODUCTS

- 14 SEER, R-410A
- Single phase
- Quiet Plus compressor sound blanket and Swept Wing fan blade
- Galvanized steel with polyester urethane coat finish
- Permanently lubricated PSC motor
- Removable top grille assembly
- Low and high pressure switches
- Liquid line filter drier (included, field installed)
- One piece top/orifice
- Easy compressor and control access
- Composite base pan
- Micro-channel coils
- CoreSense compressor protection
- Servicer-friendly jacket



PLEASE NOTE:

Maytag products are supported and sold through an authorized dealer network. Please contact your sales representative or our office for details.

RESIDENTIAL REGISTERED & MATCHED WARRANTY

Effective on product manufactured after 4-1-19. Original homeowner only. Product must be registered within 60 days of installation date. (†)

- 12 year parts, 12 year compressor, 90 day labor

RESIDENTIAL NON-REGISTERED WARRANTY

Effective on product manufactured after 4-1-19. Original homeowner only.

- 5 year parts, 5 year compressor, 90 day labor

For Contractors' Preferred Protection Plans, contact your R. A. Townsend Co. representative.

(†) IMPORTANT WARRANTY NOTE:

In order to be eligible for the full registered warranty and quality pledge, the consumer or Nortek dealer must register within 60 days of the later date of either installation or occupancy. If registration is not completed within 60 days, the warranty reverts to the non-registered (base standard) warranty.

ID ORDER#	MODEL#	SEER	NOM. TON	NOMINAL COOLING (††) CAPACITY BTUH	DIMENSIONS W x D x H
738204	PSA1BE4M1SN24K	14	2.0	24,000	23-3/4" x 23-3/4" x 32-1/2"
738205	PSA1BE4M1SN30K	14	2.5	30,000	31-3/4" x 31-3/4" x 29-1/4"
738207	PSA1BE4M1SN42K (◆)	14	3.5	42,000	31-3/4" x 31-3/4" x 41-1/4"
738208	PSA1BE4M1SN48K	14	4.0	48,000	31-3/4" x 31-3/4" x 41-1/4"
738209	PSA1BE4M1SN60K	14	5.0	60,000	31-3/4" x 31-3/4" x 45-1/4"

WHILE SUPPLIES LAST

(◆) NOTE: Add for required metering device (#920671A TXV valve or #664071R orifice)

FOR SPECIFICATIONS, SEE PAGE 505.13

FOR A/C ACCESSORIES, SEE PAGES 505.19

FOR ADDITIONAL INFORMATION, VISIT THE NORTEK WEBSITE AT www.nortekhvac.com

OUTPUT NOTE (††): Output capacity may vary slightly. See Nortek website (www.nortekhvac.com) or current AHRI directory (www.ahridirectory.com) for certified combinations and ratings.

MSH1BE HEAT PUMPS
14 SEER - 1.5 TO 5 TON CAPACITY



HEATING AND COOLING PRODUCTS

- 14 SEER, R-410A
- Single phase
- Quiet Plus compressor
- Galvanized steel with polyester urethane coat finish
- Permanently lubricated PSC motor
- Removable top grille assembly
- High pressure switch
- Liquid line filter drier (included, field installed)
- One piece fixed top/orifice
- Fixed orifice
- Easy compressor and control access
- Composite base pan
- Micro-channel coils
- 5 minute restart time delay



PLEASE NOTE:

Maytag products are supported and sold through an authorized dealer network. Please contact your sales representative or our office for details.

RESIDENTIAL REGISTERED & MATCHED WARRANTY

Effective on product manufactured after 4-1-19. Original homeowner only. Product must be registered within 60 days of installation date. (†)

- 12 year parts, 12 year compressor, 90 day labor

RESIDENTIAL NON-REGISTERED WARRANTY

Effective on product manufactured after 4-1-19. Original homeowner only.

- 5 year parts, 5 year compressor, 90 day labor

For Contractors' Preferred Protection Plans, contact your R. A. Townsend Co. representative.

(†) IMPORTANT WARRANTY NOTE:

In order to be eligible for the full registered warranty and quality pledge, the consumer or Nortek dealer must register within 60 days of the later date of either installation or occupancy. If registration is not completed within 60 days, the warranty reverts to the non-registered (base standard) warranty.

ID ORDER#	MODEL#	SEER	NOM. TON	NOMINAL COOLING (††) CAPACITY BTUH	DIMENSIONS W x D x H
739926	MSH1BE4M1SP24K	14	2.0	24,000	31-3/4" x 31-3/4" x 33-1/4"
739928	MSH1BE4M1SP30K	14	2.5	30,000	31-3/4" x 31-3/4" x 41-1/4"
739929	MSH1BE4M1SP36K	14	3.0	36,000	31-3/4" x 31-3/4" x 45-1/4"
739931	MSH1BE4M1SP48K	14	4.0	48,000	31-3/4" x 31-3/4" x 45-1/4"

WHILE SUPPLIES LAST

FOR SPECIFICATIONS, SEE PAGE 505.15

FOR A/C ACCESSORIES, SEE PAGES 505.19

FOR ADDITIONAL INFORMATION, VISIT THE NORTEK WEBSITE AT www.nortekhvac.com

OUTPUT NOTE (††): Output capacity may vary slightly. See Nortek website (www.nortekhvac.com) or current AHRI directory (www.ahridirectory.com) for certified combinations and ratings.

MAYTAG

MSH1BE HEAT PUMPS

SPECIFICATIONS



HEATING AND COOLING PRODUCTS

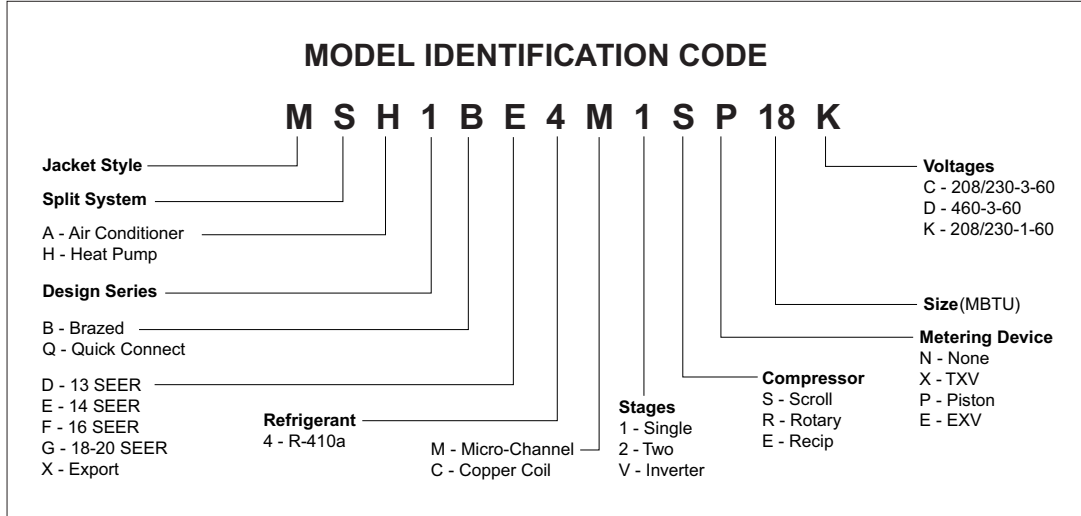

PHYSICAL AND ELECTRICAL SPECIFICATIONS / OUTDOOR UNITS

14 SEER — High Efficiency — Single Phase

Model Number MSH1BE		18K	24K	30K	36K	42K	48K	60KA
Electrical Data	Volts-Cycles-Phase (1)	208/230-60-1						
	Total Amps	9.9	14.4	13.7	15.1	19.4	21.3	26.9
	Delay Fuse Max. (2)	20	30	25	30	40	45	50
	Min. Circuit Ampacity	12.1	17.7	16.9	18.6	23.9	26.3	33.0
Fan Motor	HP	0.13	0.13	0.13	0.20	0.25	0.25	0.33
Refrigerant suction line O.D. NOTE: Liquid line is 3/8" O.D. for entire length."	0-24 ft.	3/4"	3/4"	3/4"	7/8"	7/8"	7/8"	7/8"
	25-39 ft.	3/4"	3/4"	3/4"	7/8"	7/8"	7/8"	1-1/8" (3)
	40-75 ft.	3/4"	3/4"	3/4"	7/8"	7/8"	7/8"	1-1/8" (3)
Approximate Weight (lbs.)	Net	186	192	208	204	232	256	236
	Ship	197	203	220	217	245	269	249
Sound Rating db		75	75	75	76	79	79	79

(1) Operating Voltage Range: 187v min. - 253v max.

(2) HACR Type Circuit Breakers may be used.

(3) Requires 7/8" to 1-1/8" reducer from line to unit.

Notes:

Additional charge for line sets above 15 feet.

Values based on suction line as follows with 3/8" liquid line.

a) 3/4" = 0.6 oz. per additional foot.

b) 7/8" = 0.7 oz. per additional foot.

c) 1 1/8" = 0.8 oz. per additional foot.

**FOR ADDITIONAL INFORMATION, VISIT
THE NORTEK WEBSITE AT www.nortekhvac.com**

SEPTEMBER 2024

Line #5184

MAYTAG

505.16

PSH1BE HEAT PUMPS

14 SEER - 1.5 TO 5 TON CAPACITY



HEATING AND COOLING PRODUCTS

- 14 SEER, R-410A
- Single phase
- Quiet Plus compressor
- Galvanized steel with polyester urethane coat finish
- Permanently lubricated PSC motor
- Removable top grille assembly
- Low and high pressure switches
- CoreSense compressor protection
- Liquid line filter drier (included, field installed)
- One piece top/orifice
- Fixed orifice
- Easy compressor and control access
- Composite base pan
- Micro-channel coils
- 5 minute restart time delay



PLEASE NOTE:

Maytag products are supported and sold through an authorized dealer network. Please contact your sales representative or our office for details.

RESIDENTIAL REGISTERED & MATCHED WARRANTY

Effective on product manufactured after 4-1-19. Original homeowner only. Product must be registered within 60 days of installation date. (†)

- 12 year parts, 12 year compressor, 90 day labor

RESIDENTIAL NON-REGISTERED WARRANTY

Effective on product manufactured after 4-1-19. Original homeowner only.

- 5 year parts, 5 year compressor, 90 day labor

For Contractors' Preferred Protection Plans, contact your R. A. Townsend Co. representative.

(†) IMPORTANT WARRANTY NOTE:

In order to be eligible for the full registered warranty and quality pledge, the consumer or Nortek dealer must register within 60 days of the later date of either installation or occupancy. If registration is not completed within 60 days, the warranty reverts to the non-registered (base standard) warranty.

ID ORDER#	MODEL#	SEER	NOM. TON	NOMINAL COOLING (††) CAPACITY BTUH	DIMENSIONS W x D x H
738962	PSH1BE4M1SP48K	14	4.0	48,000	31-3/4" x 31-3/4" x 45-1/4"

WHILE SUPPLIES LAST

FOR SPECIFICATIONS, SEE PAGE 505.17

FOR A/C ACCESSORIES, SEE PAGES 505.19

FOR ADDITIONAL INFORMATION, VISIT THE NORTEK WEBSITE AT www.nortekhv.com

OUTPUT NOTE (††): Output capacity may vary slightly. See Nortek website (www.nortekhv.com) or current AHRI directory (www.ahridirectory.com) for certified combinations and ratings.

MAYTAG PSH1BE HEAT PUMPS SPECIFICATIONS



HEATING AND COOLING PRODUCTS

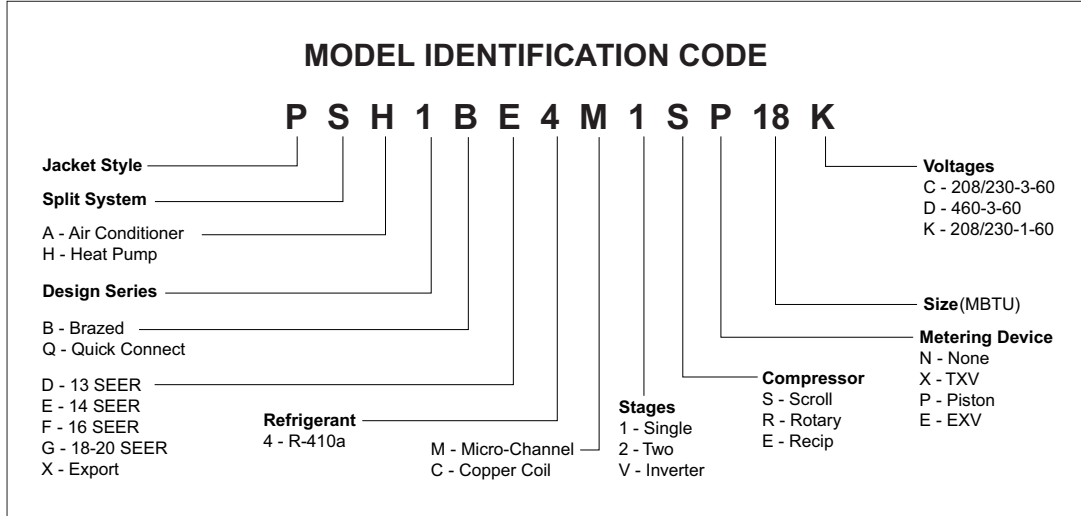

PHYSICAL AND ELECTRICAL SPECIFICATIONS / OUTDOOR UNITS

14 SEER — High Efficiency — Single Phase

Model Number PSH1BE		18K	24K	30K	36K	42K	48K	60KA
Electrical Data	Volts-Cycles-Phase (1)	208/230-60-1						
	Total Amps	9.9	14.4	13.7	15.1	19.4	21.3	26.9
	Delay Fuse Max. (2)	20	30	25	30	40	45	50
	Min. Circuit Ampacity	12.1	17.7	16.9	18.6	23.9	26.3	33.0
	Fan Motor	HP	0.13	0.13	0.13	0.20	0.25	0.25
Refrigerant suction line O.D. NOTE: Liquid line is 3/8" O.D. for entire length."	0-24 ft.	3/4"	3/4"	3/4"	7/8"	7/8"	7/8"	7/8"
	25-39 ft.	3/4"	3/4"	3/4"	7/8"	7/8"	7/8"	1-1/8" (3)
	40-75 ft.	3/4"	3/4"	3/4"	7/8"	7/8"	7/8"	1-1/8" (3)
Approximate Weight (lbs.)	Net	201	199	222	227	160	261	266
	Ship	212	210	234	240	173	274	279
Sound Rating db		71	71	71	73	74	74	74

- (1) Operating Voltage Range: 187v min. - 253v max.
- (2) HACR Type Circuit Breakers may be used.
- (3) Requires 7/8" to 1-1/8" reducer from line to unit.
- (4) Additional charge for line sets above 15 feet.
Values based on suction line as follows with 3/8" liquid line.
 - a) 3/4" = 0.6 oz. per additional foot.
 - b) 7/8" = 0.7 oz. per additional foot.
 - c) 1 1/8" = 0.8 oz. per additional foot.
- (5) For additional charging instructions, please refer to the QRD.

**FOR ADDITIONAL INFORMATION, VISIT
THE NORTEK WEBSITE AT www.nortekhvac.com**

MAYTAG

FURNACE ACCESSORIES



ID ORDER#	MODEL#	DESCRIPTION
--------------	--------	-------------

MGC2SA & MGC2SK SERIES (80%)

93776	902974	DOWNFLOW SUB-BASE KIT , for "A" cabinets
600483	904911	Same as above, but for "B", "C" and "D" cabinets
653787	905028	LP CONVERSION KIT

MGC2SD SERIES (95%)

442214	904952	CONCENTRIC VENT KIT, 2" (CVENT-2)
442215	904953	Same as above, but 3" (CVENT-3)
93776	902974	DOWNFLOW SUB-BASE KIT , for "A" cabinets
600483	904911	Same as above, but for "B", "C" and "D" cabinets
653787	905028	LP CONVERSION KIT
569309	904617	SIDE WALL VENT, 2"
569204	904347	Same as above, but 3"

PGC2TC SERIES (95%)

442214	904952	CONCENTRIC VENT KIT, 2" (CVENT-2)
442215	904953	Same as above, but 3" (CVENT-3)
653787	905028	LP CONVERSION KIT
569309	904617	SIDE WALL VENT, 2"
569204	904347	Same as above, but 3"

PGC2TE SERIES (96% speed)

442214	904952	CONCENTRIC VENT KIT, 2" (CVENT-2)
442215	904953	Same as above, but 3" (CVENT-3)
653787	905028	LP CONVERSION KIT
569309	904617	SIDE WALL VENT, 2"
569204	904347	Same as above, but 3"

PGC2TE & PGC2TN SERIES (96%)

442214	904952	CONCENTRIC VENT KIT, 2" (CVENT-2)
442215	904953	Same as above, but 3" (CVENT-3)
654336	664969	CONDENSATE DRAIN—FOR PGC2TN ONLY, 2" x 3/4"
93776	902974	DOWNFLOW SUB-BASE KIT , for "A" cabinets
600483	904911	Same as above, but for "B", "C" and "D" cabinets
653787	905028	LP CONVERSION KIT
743118	71420	PVC VENT TEE—FOR PGC2TN ONLY, 2", HxHxH
569309	904617	SIDE WALL VENT, 2"
569204	904347	Same as above, but 3"

ADDITIONAL INFORMATION, VISIT THE NORTEK WEBSITE AT www.nortekhvac.com

SEPTEMBER 2024

Line #5184

MAYTAG A/C ACCESSORIES

505.19



ID ORDER#	MODEL#	DESCRIPTION
--------------	--------	-------------

HORIZONTAL DRAIN KITS

600782	920265	HORIZONTAL DRAIN KIT , 18", C7 coils 1824-A, 3036-A, 1824-B and 3036-B
600782	920266	<i>Same as above</i> , but 24" and for C7 coils 3642-B, 30-C and 3648-C
600784	920267	<i>Same as above</i> , but 28" and for C7 coils 48-C, 60-C, 42-D, 48-D and 60-D

LOW AMBIENT KITS

568262	918837	LOW AMBIENT KIT , R-410A
--------	--------	---------------------------------

TXV VALVES

635397	920668A	TXV VALVE , R-410A, 2.0 ton
634751	920669A	<i>Same as above</i> , but 2.5 ton
635398	920670A	<i>Same as above</i> , but 3.0 ton
635399	920671A	<i>Same as above</i> , but 3.5 ton
635400	620672A	<i>Same as above</i> , but 4.0 ton
635401	920673A	<i>Same as above</i> , but 5.0 ton

FOR ADDITIONAL INFORMATION, VISIT
THE NORTEK WEBSITE AT www.nortekhv.com

KG7SA & KG7SK GAS FURNACES
80% - SINGLE STAGE - FIXED SPEED



- Single stage, fixed speed, upflow/horizontal or downflow
- FER compliant
- Multi-speed ECM direct drive blower
- Natural gas with LP conversion kit
- Low boy height
- Tubular primary heat exchanger
- 30-second blower delay
- 30-second post purge
- 60-second cooling cycle blower-off delay (TDR)
- Hot surface igniter with Smartlite technology
- Color-coded wire harness
- High static blowers
- Flexible category I venting system
- High efficiency blower kits
- Easy troubleshooting diagnostic lights
- Integrated control board
- 100% fired and tested



RESIDENTIAL REGISTERED & MATCHED WARRANTY

Effective on product manufactured after 7-1-19. Original homeowner only. Product must be registered within 60 days of installation date. (†)

- 10 year parts, lifetime heat exchanger (original owner), 90 day labor

RESIDENTIAL NON-REGISTERED WARRANTY

Effective on product manufactured after 7-1-19. Original homeowner only.

- 3 year parts, 20 year heat exchanger, 90 day labor

(†) IMPORTANT WARRANTY NOTE:

In order to be eligible for the full registered warranty and quality pledge, the consumer or Nortek dealer must register within 60 days of the later date of either installation or occupancy. If registration is not completed within 60 days, the warranty reverts to the non-registered (base standard) warranty.

For Contractors' Preferred Protection Plans, contact your R. A. Townsend Co. representative.

ID ORDER#	MODEL#	MBH CAPACITY		AFUE	HP	W x D x H	SUPPLY PLENUM OPENING
		IN	OUT				
UPFLOW/HORIZONTAL — NATURAL GAS							* = SPECIAL ORDER ITEM
740836 *	KG7SA045C-T23AP	45.0	36.0	80	1/2	14-1/4" x 28" x 34-1/2"	12-5/8" x 19"
740826 *	KG7SA054C-T23AP	52.0	42.0	80	1/2	14-1/4" x 28" x 34-1/2"	12-5/8" x 19"
740837 *	KG7SA072C-T24BP	70.0	56.0	80	3/4	17-1/2" x 28" x 34-1/2"	15-7/8" x 19"
740844	KG7SA090C-T24BP	90.0	72.0	80	3/4	17-1/2" x 28" x 34-1/2"	15-7/8" x 19"
740845 *	KG7SA090C-T35CP	90.0	72.0	80	1	21" x 28" x 34-1/2"	19-3/8" x 19"
740846	KG7SA108C-T35CP	108.0	86.0	80	1	21" x 28" x 34-1/2"	19-3/8" x 19"
740847 *	KG7SA126C-T45DP	122.0	98.0	80	1	24-1/2" x 28" x 34-1/2"	22-7/8" x 19"
DOWNFLOW — NATURAL GAS							RETURN PLENUM OPENING
740827	KG7SK054C-T23AP	54.0	43.0	80	1/2	14-1/4" x 28" x 34-1/2"	12-5/8" x 19"
740848	KG7SK072C-T24BP	72.0	58.0	80	3/4	17-1/2" x 28" x 34-1/2"	15-7/8" x 19"
740849	KG7SK090C-T24BP	90.0	72.0	80	3/4	17-1/2" x 28" x 34-1/2"	15-7/8" x 19"
740828 *	KG7SK108C-T35CP	108.0	86.4	80	1	21" x 28" x 34-1/2"	19-3/8" x 19"
740829 *	KG7SK126C-T45DP	126.0	100.8	80	1	24-1/2" x 28" x 34-1/2"	22-7/8" x 19"

FOR SPECIFICATIONS, SEE PAGE 506.1

FOR FURNACE ACCESSORIES, SEE PAGE 506.10

FOR ADDITIONAL INFORMATION, VISIT THE NORTEK WEBSITE AT www.nortekhvaca.com

GIBSON

KG7SA & KG7SK GAS FURNACES

SPECIFICATIONS

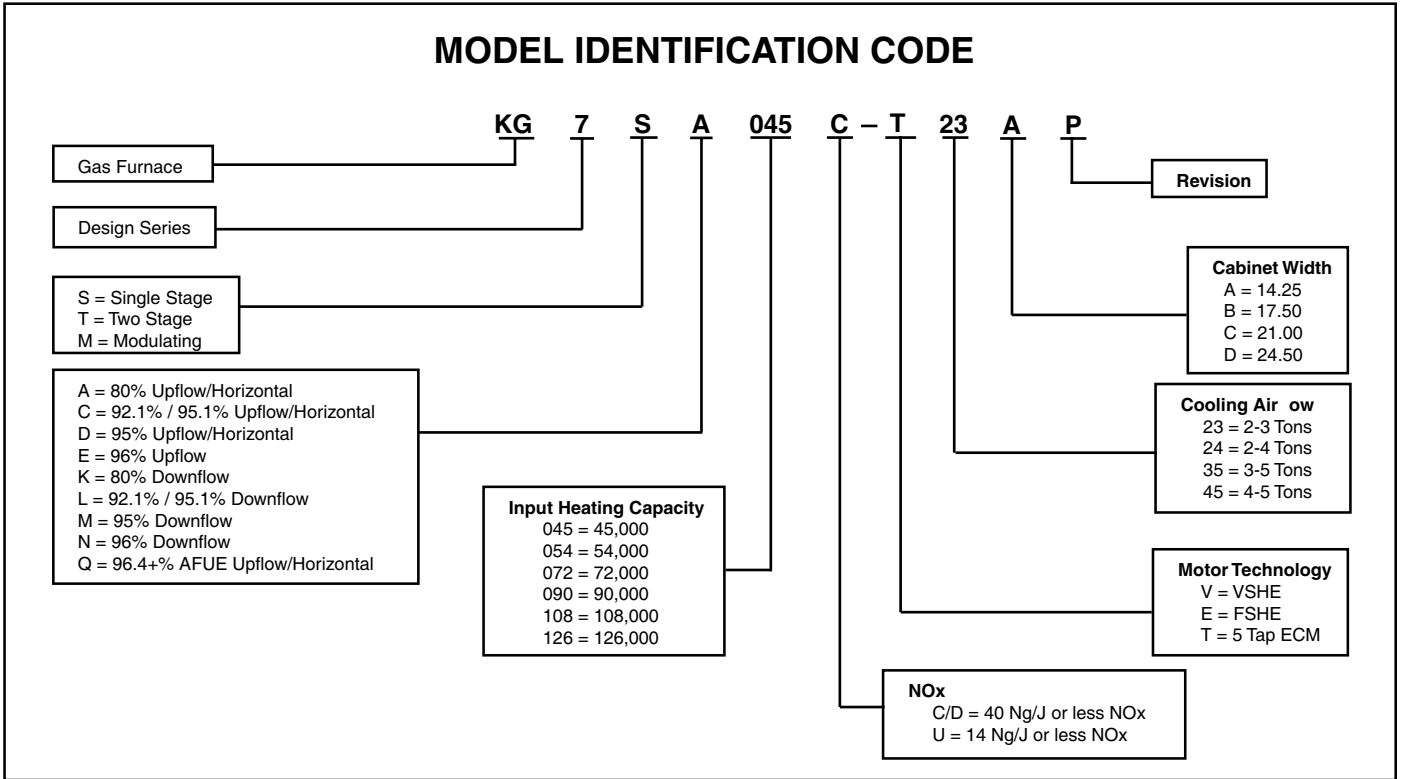

SPECIFICATIONS

KG7SA MODEL NUMBERS	-045C-T23AP	-054C-T23AP	-072C-T24BP	-072C-T35CP	-090C-T24BP	-090C-T35CP	-108C-T35CP	-126C-T45DP
Input - Btuh (a)	45,000	52,000	70,000	75,000	90,000	85,000	108,000	122,000
Heating Capacity - Btuh	36,000	42,000	56,000	60,000	72,000	68,000	86,000	98,000
AFUE	80.0	80.0	80.0	80.0	80.0	80	80	80
Motor H.P. - Speed - Type	1/2 - 5 - ECM	1/2 - 5 - ECM	3/4 - 5 - ECM	3/4 - 5 - ECM	3/4 - 5 - ECM	3/4-5-ECM	1 - 5 - ECM	1 - 5 - ECM
Motor FLA	6.4	6.4	8.8	8.8	8.8	8.8	11.5	11.5
Rated Ext. SP - In. W.C.	0.5	0.5	0.5	0.5	0.5	0.5	0.5	0.5
Temperature Rise Range - °F	30-60	30-60	30-60	35-65	35-65	35-65	35-65	40-70
Shipping Weights	95 lbs	95 lbs	110 lbs	115 lbs	115 lbs	134 lbs	136 lbs	147 lbs

KG7SK MODEL NUMBERS	-054C-T23AP	-072C-T24BP	-090C-T24BP	-108C-T35BP	-126C-T45DP
Input - Btuh (a)	54,000	72,000	90,000	Specifications not available on the Nortek website.	Specifications not available on the Nortek website.
Heating Capacity - Btuh	43,000	58,000	72,000		
AFUE	80.0	80.0	80.0		
Motor H.P. - Speed - Type	1/2 - 5 - ECM	3/4 - 5 - ECM	3/4 - 5 - ECM		
Motor FLA	6.4	8.8	8.8		
Rated Ext. SP - In. W.C.	0.5	0.5	0.5		
Temperature Rise Range - °F	30-60	35-65	35-65		
Shipping Weights	102 lbs	110 lb	115 lb		

Note: All models are 115V, 60 Hz. Gas Connections are 1/2" N.P.T. AFUE = Annual Fuel Utilization Efficiency
(a) Ratings to 2,000 ft. Over 2,000 ft. reduce 4% for each 1,000 ft. above sea level.

KG7SD GAS FURNACES
95% - SINGLE STAGE - FIXED SPEED



- Single stage, fixed speed, upflow only or downflow
- FER compliant
- ISEER, multi-speed ECM direct drive blower
- Natural gas with LP conversion kit
- Low boy height
- Tubular primary heat exchanger
- 30-second blower delay
- 30-second post purge
- 90-second cooling cycle blower-off delay (TDR)
- Hot surface igniter with Smartlite technology
- Color-coded wire harness
- High static blowers
- Flexible category IV venting system
- Sealed vestibule
- Easy troubleshooting diagnostic lights
- Integrated control board
- 100% fired and tested



RESIDENTIAL REGISTERED & MATCHED WARRANTY
Effective on product manufactured after 7-1-19. Original homeowner only. Product must be registered within 60 days of installation date. (†)

- 10 year parts, lifetime heat exchanger (original owner), 90 day labor

RESIDENTIAL NON-REGISTERED WARRANTY
Effective on product manufactured after 7-1-19. Original homeowner only.

- 3 year parts, 20 year heat exchanger, 90 day labor

For Contractors' Preferred Protection Plans, contact your R. A. Townsend Co. representative.

(†) IMPORTANT WARRANTY NOTE:

In order to be eligible for the full registered warranty and quality pledge, the consumer or Nortek dealer must register within 60 days of the later date of either installation or occupancy. If registration is not completed within 60 days, the warranty reverts to the non-registered (base standard) warranty.

ID ORDER#	MODEL#	MBH CAPACITY IN	MBH CAPACITY OUT	AFUE	HP	W x D x H	SUPPLY PLENUM OPENING
UPFLOW ONLY — NATURAL GAS							
740885	KG7SD038D-T24BP	38.0	36.0	95	3/4	17-1/2" x 28" x 34-1/2"	15-7/8" x 19"
740890	KG7SD054D-T24BP	54.0	51.0	95	3/4	17-1/2" x 28" x 34-1/2"	15-7/8" x 19"
740891 *	KG7SD072D-T35CP	72.0	68.0	95	3/4	21" x 28" x 34-1/2"	19-3/8" x 19"
740892 *	KG7SD090D-T35CP	85.0	81.0	95	1	21" x 28" x 34-1/2"	19-3/8" x 19"
740894	KG7SD108D-T45DP	108.0	103.0	95	1	24-1/2" x 28" x 34-1/2"	22-7/8" x 19"
740895 *	KG7SD120D-T45DP	120.0	114.0	95	1	24-1/2" x 28" x 34-1/2"	22-7/8" x 19"

* = SPECIAL ORDER ITEM

FOR SPECIFICATIONS, SEE PAGE 506.3

FOR FURNACE ACCESSORIES, SEE PAGES 506.10

FOR ADDITIONAL INFORMATION, VISIT THE NORTEK WEBSITE AT www.nortekhvac.com

GIBSON

KG7SD & KG7SM GAS FURNACES

SPECIFICATIONS

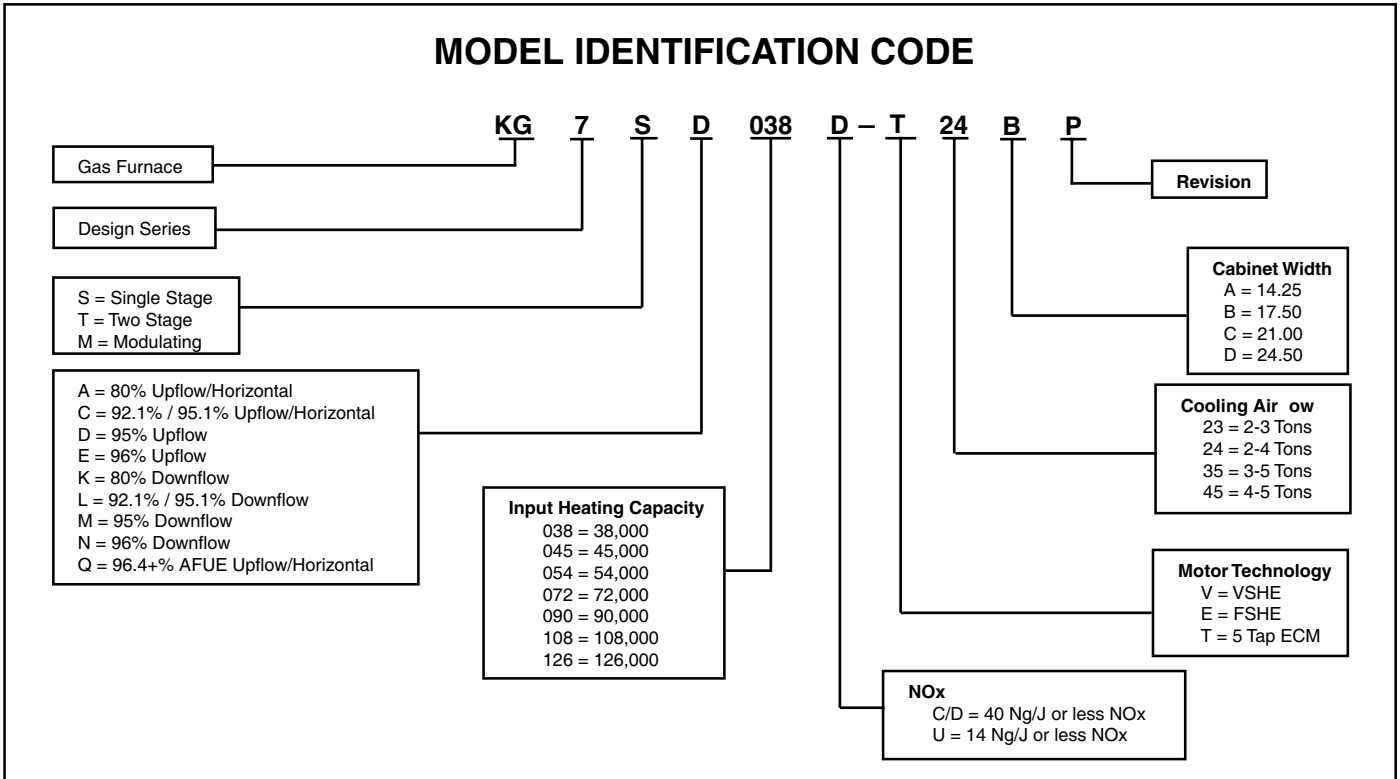

SPECIFICATIONS

KG7SD MODEL NUMBERS:	038D-T24BP	054D-T24BP	072D-T35CP	090D-T35CP	108D-T45DP	120D-T45DP
Input - Btuh (a)	38,000	54,000	72,000	85,000	108,000	Specifications not available on the Nortek website.
Heating Capacity - Btuh	36,000	51,000	68,000	81,000	103,000	
AFUE	95	95	95	95	95	
Blower D x W	10 x 8	11 x 8	10 x 10	11 x 10	11 x 10	
Motor H.P. - Speed - Type	3/4 - 5 - ECM	3/4 - 5 - ECM	3/4 - 5 - ECM	1 - 5 - ECM	1 - 5 - ECM	
Motor FLA	8.8	8.8	8.8	11.5	11.5	
Rated Ext. SP - In. W.C.	0.5	0.5	0.5	0.5	0.5	
Temperature Rise Range - °F	25-55	30-60	35-65	35-65	35-65	
Shipping Weights	100lbs	120lbs	130lbs	135lbs	155lbs	

KG7SM MODEL NUMBERS:	-054D-T24BP
Input - Btuh (a)	54,000
Heating Capacity - Btuh	51,000
AFUE	95
Blower D x W	11 x 8
Motor H.P. - Speed - Type	3/4 - 5 - ECM
Motor FLA	8.8
Rated Ext. SP - In. W.C.	0.5
Temperature Rise Range - °F	25-55
Shipping Weights	120lbs

Note: All models are 115V, 60 Hz. Gas Connections are 1/2" N.P.T. AFUE = Annual Fuel Utilization Efficiency
 (a) Ratings to 2,000 ft. Over 2,000 ft. reduce 4% for each 1,000 ft. above sea level.

KG7TC GAS FURNACES
95% - TWO STAGE - FIXED SPEED



- 2 stage, fixed speed, upflow/horizontal
- FER compliant
- Multi-speed ECM direct drive blower
- Natural gas with LP conversion kit
- Low boy height
- Tubular primary heat exchanger
- 30-second blower delay
- 30-second post purge
- 60-second cooling cycle blower-off delay (TDR)
- Hot surface igniter with Smartlite technology
- Color-coded wire harness
- High static blowers
- Flexible category IV venting system
- Sealed vestibule
- Easy troubleshooting diagnostic lights
- Integrated control board
- 100% fired and tested



RESIDENTIAL REGISTERED & MATCHED WARRANTY
Effective on product manufactured after 7-1-19. Original homeowner only. Product must be registered within 60 days of installation date. (†)

- 10 year parts, lifetime heat exchanger (original owner), 90 day labor

RESIDENTIAL NON-REGISTERED WARRANTY
Effective on product manufactured after 7-1-19. Original homeowner only.

- 3 year parts, 20 year heat exchanger, 90 day labor

For Contractors' Preferred Protection Plans, contact your R. A. Townsend Co. representative.

(†) IMPORTANT WARRANTY NOTE:

In order to be eligible for the full registered warranty and quality pledge, the consumer or Nortek dealer must register within 60 days of the later date of either installation or occupancy. If registration is not completed within 60 days, the warranty reverts to the non-registered (base standard) warranty.

ID ORDER#	MODEL#	MBH CAPACITY IN	MBH CAPACITY OUT	AFUE	HP	W x D x H	SUPPLY PLENUM OPENING
UPFLOW/HORIZONTAL — NATURAL GAS							
740850	KG7TC060D-E24BP	60.0/39.0	57.0/37.0	95.0	3/4	17-1/2" x 28" x 34-1/2"	15-7/8" x 19"
740851	KG7TC080D-E35CP	80.0/52.0	76.0/49.0	95.0	1	21" x 28" x 34-1/2"	19-3/8" x 19"
740852	KG7TC100D-E35CP	100.0/65.0	95.0/62.0	95.0	1	21" x 28" x 34-1/2"	19-3/8" x 19"
740853	KG7TC120D-E45DP	120.0/78.0	113.0/74.0	94.3	1	24-1/2" x 28" x 34-1/2"	22-7/8" x 19"

FOR SPECIFICATIONS, SEE PAGE 506.5

FOR FURNACE ACCESSORIES, SEE PAGES 506.10

FOR ADDITIONAL INFORMATION, VISIT THE NORTEK WEBSITE AT www.nortekhv.com

GIBSON

KG7TC GAS FURNACES

SPECIFICATIONS

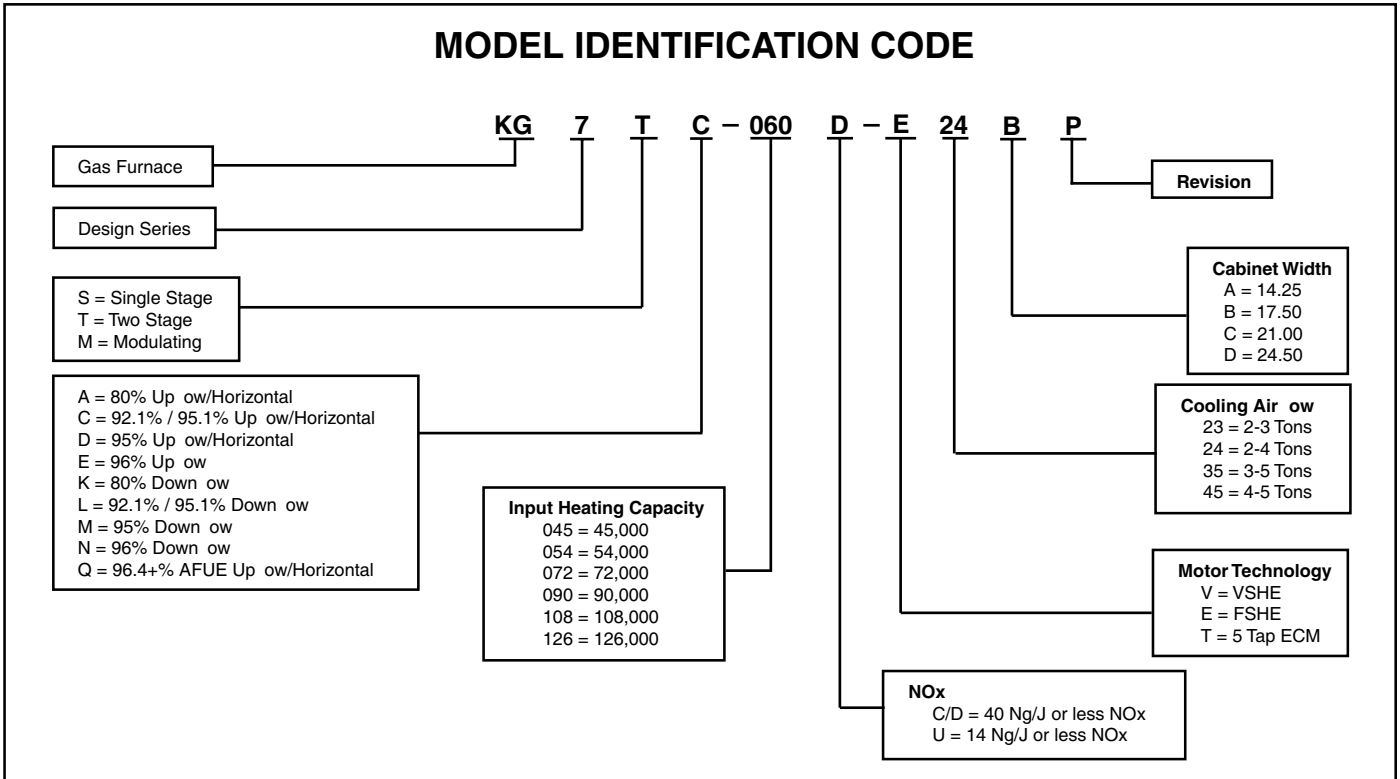

SPECIFICATIONS

KG7TC MODEL NUMBERS:	-060D-E24BP	-080D-E35CP	-100D-E35CP	-120D-E45DP
Input - Btuh (a)	60,000 / 39,000	80,000 / 52,000	100,000 / 65,000	120,000 / 78,000
Heating Capacity - BtuH	57,000 / 37,000	76,000 / 49,000	95,000 / 62,000	113,000 / 74,000
AFUE	95.0	95.0	95.0	94.3
Motor H.P. - Speed - Type	3/4 - BLDC	1 - BLDC	1 - BLDC	1 - BLDC
Motor FLA	8.8	11.5	11.5	11.5
Rated Ext. SP - In. W.C.	0.50	0.50	0.50	0.50
Temperature Rise Range - F	30-60	35-65	35-65	40-70
Shipping Weights	120 lb	130 lb	140 lb	155 lb
SKU	1025920K	1025921K	1025922K	1025923K

Note:

All models are 115V, 60 Hz. Gas Connections are 1/2" N.P.T. AFUE = Annual Fuel Utilization Efficiency
 (a) Ratings to 2,000 ft. Over 2,000 ft. reduce 4% for each 1,000 ft. above sea level.

KG7TN GAS FURNACES
96% - TWO STAGE - FIXED SPEED



- 2 stage, fixed speed, downflow only
- FER compliant
- Multi-speed ECM direct drive blower
- Natural gas with LP conversion kit
- Low boy height
- Tubular primary heat exchanger
- 30-second blower delay
- 30-second post purge
- 60-second cooling cycle blower-off delay (TDR)
- Hot surface igniter with Smartlite technology
- Color-coded wire harness
- Sealed vestibule
- Flexible category IV venting system
- High efficiency blower kits
- Easy troubleshooting diagnostic lights
- Integrated control board
- 100% fired and tested



RESIDENTIAL REGISTERED & MATCHED WARRANTY
Effective on product manufactured after 4-1-19. Original homeowner only. Product must be registered within 60 days of installation date. (†)

- 10 year parts, lifetime heat exchanger (original owner), 90 day labor

RESIDENTIAL NON-REGISTERED WARRANTY
Effective on product manufactured after 4-1-19. Original homeowner only.

- 3 year parts, 20 year heat exchanger, 90 day labor

For Contractors' Preferred Protection Plans, contact your R. A. Townsend Co. representative.

(†) IMPORTANT WARRANTY NOTE:

In order to be eligible for the full registered warranty and quality pledge, the consumer or Nortek dealer must register within 60 days of the later date of either installation or occupancy. If registration is not completed within 60 days, the warranty reverts to the non-registered (base standard) warranty.

VENTING NOTE FOR KG7TN SERIES:

If venting out the right or left side, a #664969 condensate drain and a #71420 2" PVC vent tee are required. These accessories are not required if venting out of the top of the furnace.

ID ORDER#	MODEL#	MBH CAPACITY IN	MBH CAPACITY OUT	AFUE	HP	W x D x H	RETURN PLENUM OPENING
DOWNFLOW ONLY — NATURAL GAS							
740870	KG7TN060D-E24BP	60.0/39.0	58.0/37.0	96.0	3/4	17-1/2" x 28" x 34-1/2"	15-7/8" x 19"
740871	KG7TN080D-E35CP	80.0/52.0	77.0/50.0	96.0	1	21" x 28" x 34-1/2"	19-3/8" x 19"
740872	KG7TN100D-E35CP	100.0/65.0	96.0/62.0	96.0	1	21" x 28" x 34-1/2"	19-3/8" x 19"
740873 *	KG7TN115D-E45DP	115.0/75.0	110.0/72.0	96.0	1	24-1/2" x 28" x 34-1/2"	22-7/8" x 19"

* = SPECIAL ORDER ITEM

FOR SPECIFICATIONS, SEE PAGE 506.7

FOR FURNACE ACCESSORIES, SEE PAGE 506.10

FOR ADDITIONAL INFORMATION, VISIT THE NORTEK WEBSITE AT www.nortekhvac.com

GIBSON

KG7TN GAS FURNACES SPECIFICATIONS



MODEL IDENTIFICATION CODE

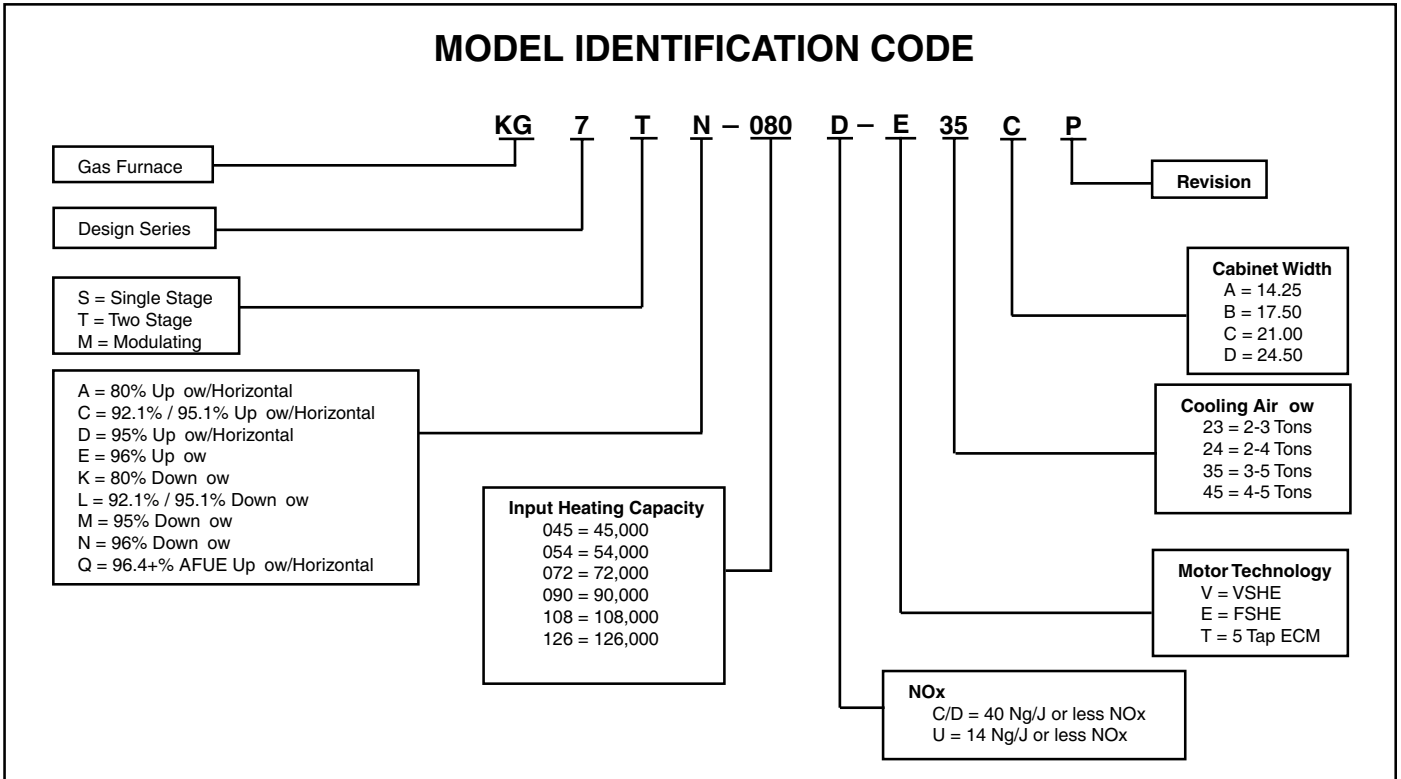

SPECIFICATIONS

KG7TN MODEL NUMBERS	-060D-E24BP	-080D-E35CP	-100D-E35CP	-115D-E45DP
Input - Btuh (a)	60,000 / 39,000	80,000 / 52,000	100,000 / 65,000	115,000 / 75,000
Heating Capacity - BtuH	58,000 / 37,000	77,000 / 50,000	96,000 / 62,000	110,000 / 72,000
AFUE	96.0	96.0	96.0	96.0
Motor H.P. - Speed - Type	3/4 - BLDC	1 - BLDC	1 - BLDC	1 - BLDC
Motor FLA	8.8	11.5	11.5	11.5
Rated Ext. SP - In. W.C.	0.50	0.50	0.50	0.50
Temperature Rise Range - F	30-60	35-65	35-65	40-70
Shipping Weights	120 lb	130 lb	135 lb	145 lb
SKU	1025962K	1025963K	1025964K	1025965K

Note:

All models are 115V, 60 Hz. Gas Connections are 1/2" N.P.T. AFUE = Annual Fuel Utilization Efficiency

(a) Ratings to 2,000 ft. Over 2,000 ft. reduce 4% for each 1,000 ft. above sea level.

WSA2BD CONDENSERS
13 SEER - 1.5 TO 5 TON CAPACITY



- 13 SEER, R-410A
- Single phase
- Copeland scroll compressor
- Full service brass valves
- Galvanized steel with polyester urethane coat finish
- Permanently lubricated PSC motor
- Removable top grille assembly
- High pressure switch
- Liquid line filter drier (included, field installed)
- One piece top/orifice
- Easy compressor and control access
- Composite base pan
- All-aluminum coils
- Powder-coated wire guard and mesh hail guard



RESIDENTIAL REGISTERED & MATCHED WARRANTY
Effective on product manufactured after 7-1-19. Original homeowner only. Product must be registered within 60 days of installation date. (†)

- 10 year parts, 10 year compressor, 90 day labor

RESIDENTIAL NON-REGISTERED WARRANTY
Effective on product manufactured after 7-1-19. Original homeowner only.

- 3 year parts, 3 year compressor, 90 day labor

For Contractors' Preferred Protection Plans, contact your R. A. Townsend Co. representative.

(†) IMPORTANT WARRANTY NOTE:

In order to be eligible for the full registered warranty and quality pledge, the consumer or Nortek dealer must register within 60 days of the later date of either installation or occupancy. If registration is not completed within 60 days, the warranty reverts to the non-registered (base standard) warranty.

ID ORDER#	MODEL#	SEER	NOM. TON	NOMINAL COOLING (††) CAPACITY BTUH	DIMENSIONS W x D x H
739765	WSA2BD4M1SN18K	13	1.5	18,000	22-3/4" x 22-3/4" x 24-1/2"
739766	WSA2BD4M1SN24KA	13	2.0	24,000	22-3/4" x 22-3/4" x 24-1/2"
739767	WSA2BD4M1SN30K	13	2.5	30,000	22-3/4" x 22-3/4" x 28-1/2"
739768	WSA2BD4M1SN36K	13	3.0	36,000	22-3/4" x 22-3/4" x 28-1/2"
739769	WSA2BD4M1SN42K	13	3.5	42,000	30-3/4" x 30-3/4" x 29-1/4"
739770	WSA2BD4M1SN48K	13	4.0	48,000	30-3/4" x 30-3/4" x 29-1/4"
739771	WSA2BD4M1SN60K	13	5.0	60,000	30-3/4" x 30-3/4" x 33-1/4"

FOR SPECIFICATIONS, SEE PAGE 506.9

FOR A/C ACCESSORIES, SEE PAGES 506.11

FOR ADDITIONAL INFORMATION, VISIT THE NORTEK WEBSITE AT www.nortekhv.com

OUTPUT NOTE (††): Output capacity may vary slightly. See Nortek website (www.nortekhv.com) or current AHRI directory (www.ahridirectory.com) for certified combinations and ratings.

GIBSON

WSA2BD CONDENSERS SPECIFICATIONS

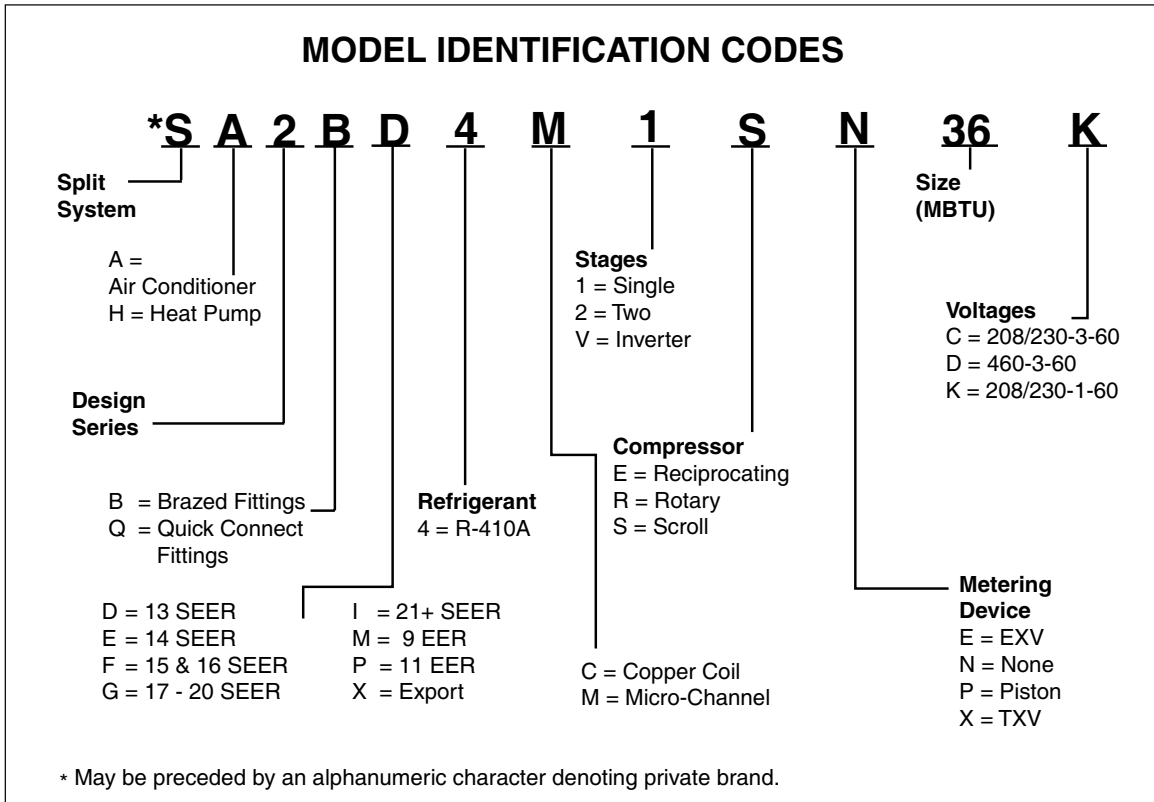

PHYSICAL AND ELECTRICAL SPECIFICATIONS / OUTDOOR UNITS

13 SEER — High Efficiency — Single Phase

Model Number WSA2BD4M1		SN18K	SN24KA	SN30K	SN36K	SN42K	SN48K	SN60K
Electrical Data	Volts-Cycles-Phase (1)	208/230-60-1						
	Delay Fuse Max. (2)	20	25	30	35	40	50	60
	Min. Circuit Ampacity	12.0	16.7	18.3	22.0	23.0	28.6	34.2
	Fan Motor HP	0.125	0.125	0.125	0.25	0.25	0.25	0.25
Refrigerant suction line O.D. NOTE: Liquid line is 3/8" O.D. for entire length.	0-24 ft.	3/4"	3/4"	3/4"	3/4"	7/8"	7/8"	7/8"
	25-39 ft.	3/4"	3/4"	3/4"	7/8" (3)	7/8"	7/8"	1-1/8" (4)
	40-75 ft.	3/4"	3/4"	3/4"	7/8" (3)	7/8"	7/8"	1-1/8" (4)
Approximate Weight (lbs.)	Net	93	99	103	108	151	144	175
	Ship	106	112	117	122	172	165	197
Sound Rating db		74	74	74	76	79	79	79

(1) Operating Voltage Range: 187v min. - 253v max.
 (2) HACR Type Circuit Breakers may be used.
 (3) Requires 7/8" to 3/4" reducer from line to unit.
 (4) Requires 7/8" to 1-1/8" reducer from line to unit.

GIBSON FURNACE ACCESSORIES



ID ORDER#	MODEL#	DESCRIPTION
KG7SA & KG7SK SERIES (80%)		
93776	902974	DOWNFLOW SUB-BASE KIT , for "A" cabinets
600483	904911	Same as above, but for "B", "C" and "D" cabinets
653787	905028	LP CONVERSION KIT
KG7SD SERIES (95%)		
654336	664969	CONDENSATE DRAIN , 2" x 3/4"
93776	902974	DOWNFLOW SUB-BASE KIT , for "A" cabinets
600483	904911	Same as above, but for "B", "C" and "D" cabinets
653787	905028	LP CONVERSION KIT
743118	71420	PVC VENT TEE , 2", HxHxH
569309	904617	SIDE WALL VENT , 2"
569204	904347	Same as above, but 3"
KG7TC SERIES (95%)		
653787	905028	LP CONVERSION KIT
569309	904617	SIDE WALL VENT , 2"
569204	904347	Same as above, but 3"
KG7TN SERIES (96%)		
654336	664969	CONDENSATE DRAIN , 2" x 3/4"
93776	902974	DOWNFLOW SUB-BASE KIT , for "A" cabinets
600483	904911	Same as above, but for "B", "C" and "D" cabinets
653787	905028	LP CONVERSION KIT
743118	71420	PVC VENT TEE , 2", HxHxH
569309	904617	SIDE WALL VENT , 2"
569204	904347	Same as above, but 3"

**FOR ADDITIONAL INFORMATION, VISIT
THE NORTEK WEBSITE AT www.nortekhvac.com**

GIBSON A/C ACCESSORIES



ID ORDER#	MODEL#	DESCRIPTION
--------------	--------	-------------

HORIZONTAL DRAIN KITS

600782	920265	HORIZONTAL DRAIN KIT , 18", C7 coils 1824-A, 3036-A, 1824-B and 3036-B
600782	920266	<i>Same as above</i> , but 24" and for C7 coils 3642-B, 30-C and 3648-C
600784	920267	<i>Same as above</i> , but 28" and for C7 coils 48-C, 60-C, 42-D, 48-D and 60-D

LOW AMBIENT KITS

568262	918837	LOW AMBIENT KIT , R-410A
--------	--------	---------------------------------

TXV VALVES

635397	920668A	TXV VALVE , R-410A, 2.0 ton
634751	920669A	<i>Same as above</i> , but 2.5 ton
635398	920670A	<i>Same as above</i> , but 3.0 ton
635399	920671A	<i>Same as above</i> , but 3.5 ton
635400	620672A	<i>Same as above</i> , but 4.0 ton
635401	920673A	<i>Same as above</i> , but 5.0 ton

**FOR ADDITIONAL INFORMATION, VISIT
THE NORTEK WEBSITE AT www.nortekhv.com**

MAMMOTH WSA2BD CONDENSERS

13 SEER - THREE PHASE - 3 TO 5 TON CAPACITY

- 13 SEER, R-410A
- FER compliant
- Copeland scroll compressor
- Full service valves
- Permanently lubricated PSC motor
- Corrosion-resistant drain pan
- Liquid line filter drier
- Galvanized steel cabinet
- Removable top grille assembly
- High pressure switch
- One-piece top/orifice
- Easy compressor and control access
- All-aluminum coils
- Powder-coated wire guard and mesh hail guard



WHILE SUPPLIES LAST

COMMERCIAL WARRANTY

Effective on product manufactured after 7-1-19.
Original homeowner only.

- 1 year parts, 5 year compressor, 90 day labor
- For Contractors' Preferred Protection Plans, contact your R. A. Townsend Co. representative.**

ID ORDER#	MODEL#	SEER	NOM. COOLING BTUH (†)	NOM. TON.	MOTOR HP	DIMENSION W x D x H (††)
740760	WSA2BD4M1SN36C	13	36,000	3	1/4	23-3/4" x 23-3/4" x 28-1/2"
740761	WSA2BD4M1SN48C	13	48,000	4	1/4	31-3/4" x 31-3/4" x 29-1/4"
740762	WSA2BD4M1SN60C	13	60,000	5	1/4	31-3/4" x 31-3/4" x 33-1/4"

FOR SPECIFICATIONS, SEE PAGE 507.1
FOR ACCESSORIES, SEE PAGES 507.4
FOR ADDITIONAL INFORMATION, VISIT THE NORTEK WEBSITE AT www.nortekhvac.com

NOTE: Shipped as downflow. Horizontal applications require a horizontal supply and return kit.

OUTPUT NOTE (†): Output capacity may vary slightly. See Nortek website (www.nortekhvac.com) or current AHRI directory (www.ahridirectory.com) for certified combinations and ratings.

DIMENSIONS NOTE(††): The height dimension includes the base rails.

MAMMOTH WSA2BD CONDENSERS SPECIFICATIONS

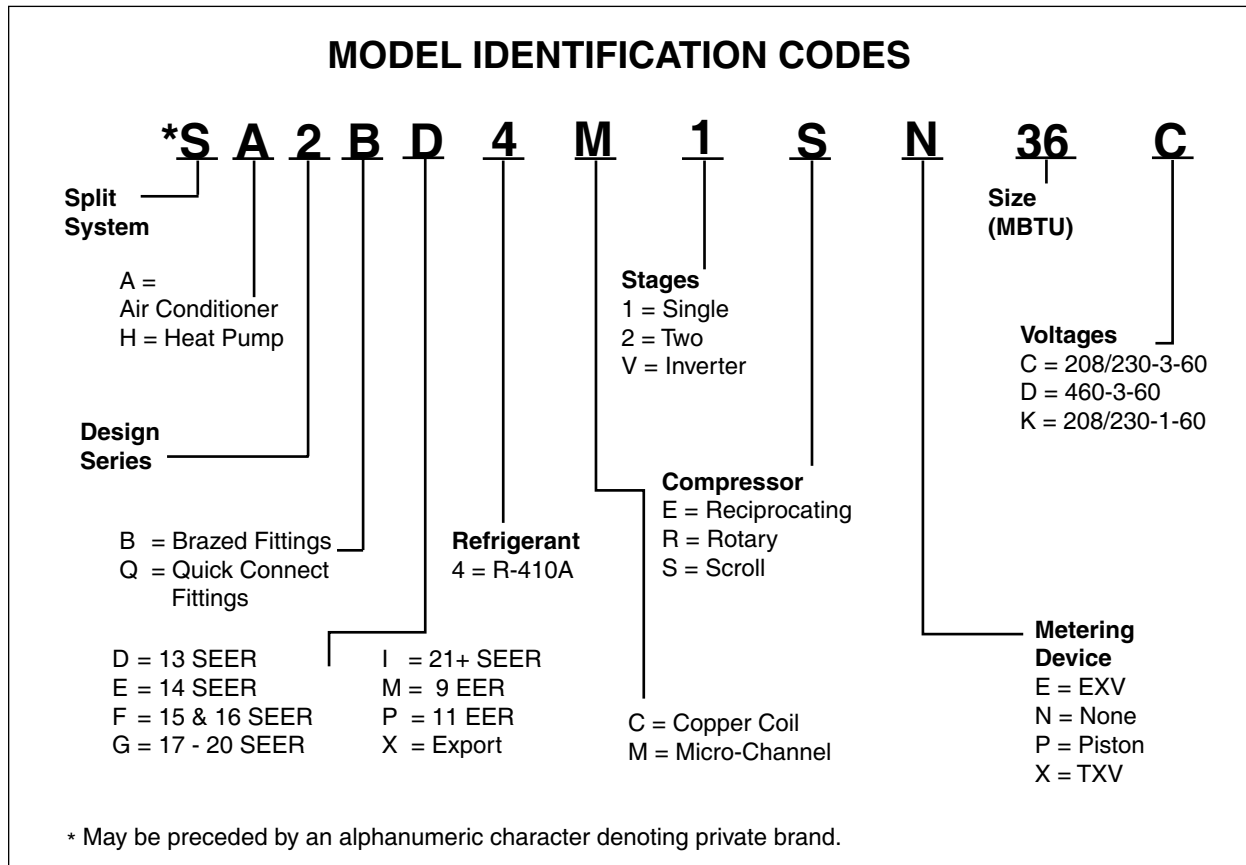

PHYSICAL AND ELECTRICAL SPECIFICATIONS / OUTDOOR UNITS

13 SEER — High Efficiency — Three Phase

Model Number WSA2BD		036CB	048CB	060CB	036DB	048DB	060DB
Electrical Data	Volts-Cycles-Phase (1)	208/230-60-3			460-60-3		
	Total Amps	11.8	15.2	17.4	6.5	6.9	8.4
	Delay Fuse Max. (2)	20	30	35	15	15	15
	Min. Circuit Ampacity	14.4	18.6	21.4	7.9	8.5	10.4
	Fan Motor	HP	0.25	0.25	0.25	0.25	0.25
Fan Blade	SCFM	3000	3500	3800	3000	3500	3800
Refrigerant suction line O.D. NOTE: Liquid line is 3/8" O.D. for entire length.	0-24 ft.	3/4"	7/8"	7/8"	3/4"	7/8"	7/8"
	25-39 ft.	7/8" (3)	7/8"	1-1/8" (4)	7/8" (3)	7/8"	1-1/8" (4)
	40-75 ft.	7/8" (3)	7/8"	1-1/8" (4)	7/8" (3)	7/8"	1-1/8" (4)
Refrigerant charge R-410A in ounces for outdoor unit & 15' lineset		65.6	80.0	80.0	65.6	80.0	80.0
Approximate Weight (lbs.)	Net	109	160	162	109	160	162
	Ship	115	169	171	115	169	171
Sound Rating db		76	79	79	76	79	79

Information from Nortek Technical Specification #396F-0419

C7 COILS WITH ORIFICE
13+ SEER - VERTICAL - UNCASSED

- 13+ SEER, R-410A
- Vertical uncased
- Micro-channel coil

RESIDENTIAL WARRANTY

Effective on product manufactured after 7-1-19.

- 3 year parts only to original owner if purchased as a separate item

For TXV valves, see page 508.11

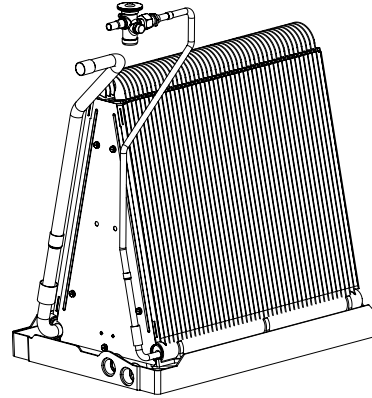

MODEL IDENTIFICATION CODE

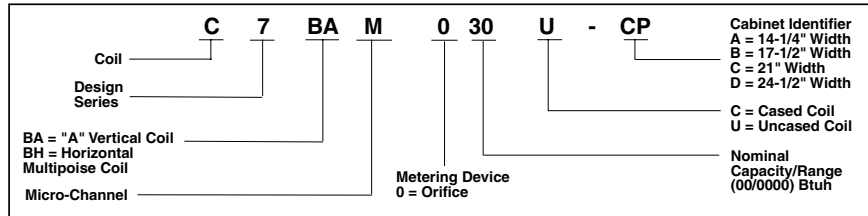

WHILE SUPPLIES LAST

ID ORDER#	MODEL#	SEER	NOM. TONS	NOMINAL AIRFLOW CFM		REFRIGERANT CONNECTIONS		METERING ORIFICE SIZE
				LOWER TONNAGE	HIGHER TONNAGE	SUCTION	LIQUID	
685731	C7BAM01824U-BP	13+	1.5-2	550	750	3/4" OD	3/8" OD	0.055
713413	C7BAM030U-CP	13+	2.5	960	960	3/4" OD	3/8" OD	0.061
665379	C7BAM03036U-BP	13+	2.5-3	1,000	1,200	3/4" OD	3/8" OD	0.067
664099	C7BAM03642U-BP	13+	3-3.5	1,300	1,300	7/8" OD	3/8" OD	0.071
664100	C7BAM03648U-CP	13+	3-4	1,250	1,400	7/8" OD	3/8" OD	0.067
674796	C7BAM060U-DP	13+	5	1,700	1,700	7/8" OD	3/8" OD	0.083

DIMENSIONAL DATA

MODEL	CABINET OVERALL DIMENSIONS			CABINET BOTTOM OPENING		CABINET TOP OPENING		COIL ONLY		
	Width	Depth	Height	Width	Depth	Width	Depth	Width	Depth	Height
C7BAM01824U-BP	--	--	--	--	--	--	--	16"	19-1/2"	18"
C7BAM030U-CP	--	--	--	--	--	--	--	19-1/2"	19-1/2"	18"
C7BAM03036U-AP	--	--	--	--	--	--	--	12-3/4"	19-1/2"	18-1/2"
C7BAM03036U-BP	--	--	--	--	--	--	--	16"	19-1/2"	18"
C7BAM03642U-BP	--	--	--	--	--	--	--	16"	19-1/2"	25"
C7BAM03648U-CP	--	--	--	--	--	--	--	19-1/2"	19-1/2"	24-1/2"
C7BAM060U-DP	--	--	--	--	--	--	--	23"	19-1/2"	27-3/4"

C7 COILS WITH ORIFICE 13+ SEER - VERTICAL - CASED

- 13+ SEER, R-410A
- Vertical cased
- Micro-channel coil

RESIDENTIAL WARRANTY

Effective on product manufactured after 7-1-19.

- 3 year parts only to original owner if purchased as a separate item

For TXV valves, see page 508.11

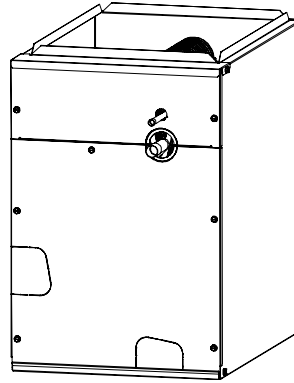

HEATING AND COOLING PRODUCTS



MODEL IDENTIFICATION CODE

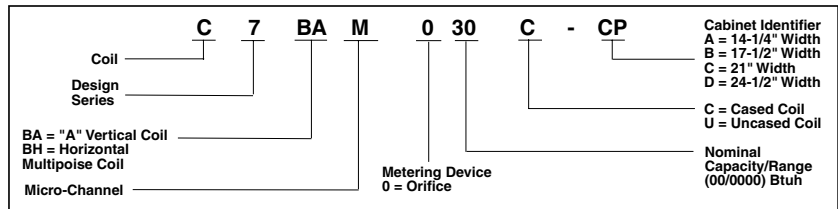

WHILE SUPPLIES LAST

ID ORDER#	MODEL#	SEER	NOM. TONS	NOMINAL AIRFLOW CFM		REFRIGERANT CONNECTIONS		METERING ORIFICE SIZE
				LOWER TONNAGE	HIGHER TONNAGE	SUCTION	LIQUID	
738327	C7BAM03642C-BP	13+	3-3.5	1,300	1,300	7/8" OD	3/8" OD	0.071
664695	C7BAM03648C-CP	13+	3-4	1,250	1,400	7/8" OD	3/8" OD	0.067
738114	C7BAM048C-DP	13+	4	1,300	1,300	7/8" OD	3/8" OD	0.077
738115	C7BAM060C-CP	13+	5	1,700	1,700	7/8" OD	3/8" OD	0.083

DIMENSIONAL DATA

MODEL	CABINET OVERALL DIMENSIONS			CABINET BOTTOM OPENING		CABINET TOP OPENING		COIL ONLY		
	Width	Depth	Height	Width	Depth	Width	Depth	Width	Depth	Height
C7BAM03642C-BP	17-1/2"	20-3/4"	26-3/4"	9-7/8"	16-3/8"	16-1/8"	17-3/4"	16"	19-1/2"	25"
C7BAM03648C-CP	21"	20-3/4"	26-3/4"	12-3/8"	16-3/8"	19-5/8"	17-3/4"	19-1/2"	19-1/2"	24-1/2"
C7BAM048C-DP	24-1/2"	20-3/4"	30-1/4"	16-7/8"	16-3/8"	23-1/8"	17-3/4"	23"	19-1/2"	27-3/4"
C7BAM060C-CP	21"	20-3/4"	30-1/4"	12-3/8"	16-3/8"	19-5/8"	17-3/4"	19-1/2"	19-1/2"	28-1/2"

C7 COILS WITH ORIFICE
13+ SEER - MULTI-POISE - CASED

- 13+ SEER, R-410A
- Multi-poise cased
- Micro-channel coil

RESIDENTIAL WARRANTY

Effective on product manufactured after 7-1-19.

- 3 year parts only to original owner if purchased as a separate item

For TXV valves, see page 508.11

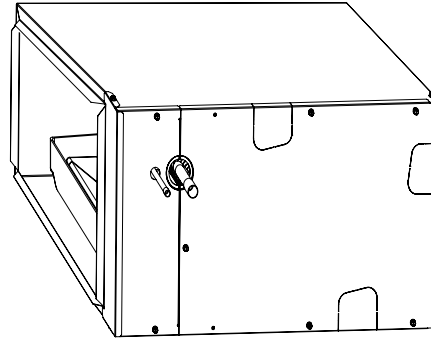

HEATING AND COOLING PRODUCTS



MODEL IDENTIFICATION CODE

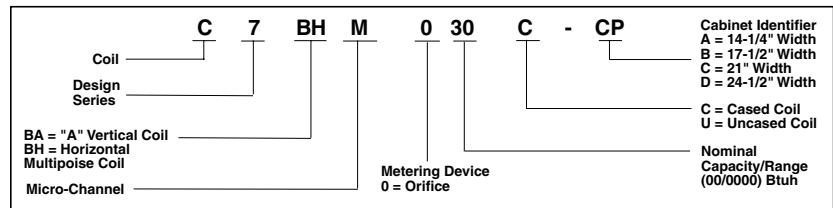

ID ORDER#	MODEL#	SEER	NOM. TONS	NOMINAL AIRFLOW CFM		REFRIGERANT CONNECTIONS		METERING ORIFICE SIZE
				LOWER TONNAGE	HIGHER TONNAGE	SUCTION	LIQUID	
659051	C7BHM01824C-AP	13+	1.5-2	600	700	3/4" OD	3/8" OD	0.048
659053	C7BHM01824C-BP	13+	1.5-2	550	750	3/4" OD	3/8" OD	0.055
659057 *	C7BHM030C-CP	13+	2.5	960	960	3/4" OD	3/8" OD	0.061
659055	C7BHM03036C-AP	13+	2.5-3	1,000	1,200	3/4" OD	3/8" OD	0.061
659056	C7BHM03036C-BP	13+	2.5-3	1,000	1,200	3/4" OD	3/8" OD	0.067
659058	C7BHM03642C-BP	13+	3-3.5	1,300	1,300	7/8" OD	3/8" OD	0.071
659059	C7BHM03648C-CP	13+	3-4	1,250	1,400	7/8" OD	3/8" OD	0.067
659065	C7BHM048C-CP	13+	4	1,300	1,300	7/8" OD	3/8" OD	0.077
659066	C7BHM048C-DP	13+	4	1,300	1,300	7/8" OD	3/8" OD	0.077
674795	C7BHM060C-CP	13+	5	1,700	1,700	7/8" OD	3/8" OD	0.083
674794	C7BHM060C-DP	13+	5	1,700	1,700	7/8" OD	3/8" OD	0.083

MODEL	DIMENSIONAL DATA									
	CABINET OVERALL DIMENSIONS			CABINET BOTTOM OPENING		CABINET TOP OPENING		COIL ONLY		
	Width	Depth	Height	Width	Depth	Width	Depth	Width	Depth	Height
C7BHM01824C-AP	14-1/4"	20-3/4"	26-3/4"	6-5/8"	16-3/8"	12-7/8"	17-3/4"	12-3/4"	19-1/2"	18-1/2"
C7BHM01824C-BP	17-1/2"	20-3/4"	26-3/4"	9-7/8"	16-3/8"	16-1/8"	17-3/4"	16"	19-1/2"	18"
C7BHM030C-CP	21"	20-3/4"	26-3/4"	12-3/8"	16-3/8"	19-5/8"	17-3/4"	19-1/2"	19-1/2"	18"
C7BHM03036C-AP	14-1/4"	20-3/4"	26-3/4"	6-5/8"	16-3/8"	12-7/8"	17-3/4"	12-3/4"	19-1/2"	18-1/2"
C7BHM03036C-BP	17-1/2"	20-3/4"	26-3/4"	9-7/8"	16-3/8"	16-1/8"	17-3/4"	16"	19-1/2"	18"
C7BHM03642C-BP	17-1/2"	20-3/4"	26-3/4"	9-7/8"	16-3/8"	16-1/8"	17-3/4"	16"	19-1/2"	25"
C7BHM03648C-CP	21"	20-3/4"	26-3/4"	12-3/8"	16-3/8"	19-5/8"	17-3/4"	19-1/2"	19-1/2"	24-1/2"
C7BHM048C-CP	21"	20-3/4"	30-1/4"	12-3/8"	16-3/8"	19-5/8"	17-3/4"	19-1/2"	19-1/2"	24-1/2"
C7BHM048C-DP	24-1/2"	20-3/4"	30-1/4"	16-7/8"	16-3/8"	23-1/8"	17-3/4"	23"	19-1/2"	27-3/4"
C7BHM060C-CP	21"	20-3/4"	30-1/4"	12-3/8"	16-3/8"	19-5/8"	17-3/4"	19-1/2"	19-1/2"	28-1/2"
C7BHM060C-DP	24-1/2"	20-3/4"	30-1/4"	16-7/8"	16-3/8"	23-1/8"	17-3/4"	23"	19-1/2"	27-3/4"

B6BMMX AIR HANDLERS WITH COIL
13+ SEER - MULTI-POISED/MULTI- SPEED



- **With micro-channel all-aluminum coil and TXV valve.**
- 13+ SEER, R-410A (†)
- Multi-poised — horizontal, upflow, downflow and vertical applications
- Multi-speed
- Plug-in heater kits
- Circuit board with blower time delay, low voltage terminal strip and heat strip sequencing
- Control board with field-selectable sequence timing
- 1" cabinet insulation
- Built-in filter rack
- Plug-in wire connections and modularity
- Breaker accessible from front of unit when heater is applied
- Galvanized steel with polyester urethane finish



RESIDENTIAL WARRANTY

Effective on product manufactured after 7-1-19.

- 3 year parts only to original owner if purchased as a separate item

WHILE SUPPLIES LAST

ID ORDER#	MODEL#	SEER(†)	NOM. TON.	NOM. COOLING BTUH(††)	HP	SPEED	REFRIGERANT CONNECTIONS		DIMENSIONS (W x D x H)
							SUCTION	LIQUID	
756646	B6BMMX30K-BP	13+	2.5	30,000	1/3	3-PSC	3/4" OD	3/8" OD	19-11/16" x 22" x 43-5/16"
751974	B6BMMX36K-BP	13+	3.0	36,000	1/3	3-PSC	3/4" OD	3/8" OD	19-11/16" x 22" x 43-5/16"
756647	B6BMMX42K-BP	13+	3.5	42,000	1/3	3-PSC	7/8" OD	3/8" OD	19-11/16" x 22" x 49-5/16"
751975	B6BMMX48K-CP	13+	4.0	48,000	1/2	3-PSC	7/8" OD	3/8" OD	22-7/16" x 22" x 55-15/16"

MODEL IDENTIFICATION CODE

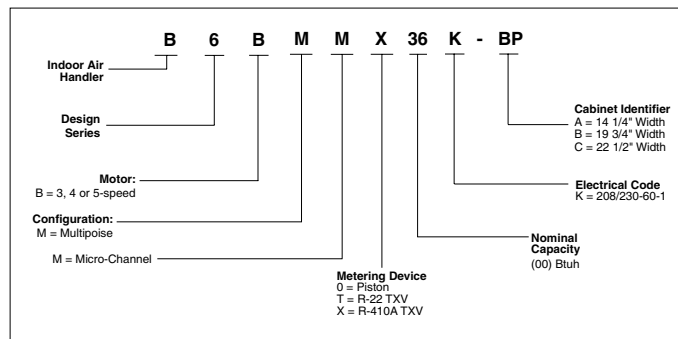

FOR SPECIFICATIONS, SEE PAGE 508.4 and 508.5

FOR A/C ACCESSORIES, SEE PAGES 508.11

FOR ADDITIONAL INFORMATION, VISIT THE NORTEK WEBSITE AT www.nortekhvac.com

OUTPUT NOTE (††): Output capacity may vary slightly. See Nortek website (www.nortekhvac.com) or current AHRI directory (www.ahridirectory.com) for certified combinations and ratings.

B6BMMX AIR HANDLERS WITH COIL
BLOWER PERFORMANCE DATA



BLOWER PERFORMANCE DATA

		Dry Coil ESP							
		0.10	0.20	0.30	0.40	0.50	0.60	0.70	0.80
*24K, A-Cabinet	Low	683	647	607	563	515	463	406	345
	Corrected ESP ¹	0.00	0.07	0.19	0.30	0.42	0.53	0.65	0.76
	Medium	861	823	781	734	682	625	564	498
	Corrected ESP ¹	0.00	0.00	0.11	0.23	0.36	0.48	0.60	0.72
	High	1072	1026	975	920	860	797	730	659
	Corrected ESP ¹	0.00	0.00	0.00	0.14	0.27	0.40	0.53	0.67
*30"36K, A-Cabinet	Low	849	825	793	753	704	647	581	508
	Corrected ESP ¹	0.00	0.04	0.15	0.27	0.38	0.50	0.62	0.74
	Medium	1118	1087	1046	997	940	874	799	717
	Corrected ESP ¹	0.00	0.00	0.04	0.17	0.29	0.42	0.55	0.68
	High	1277	1233	1184	1130	1070	1005	935	860
	Corrected ESP ¹	0.00	0.00	0.00	0.10	0.23	0.36	0.49	0.63
*24K, B-Cabinet	Low	708	690	664	628	584	532	471	401
	Corrected ESP ¹	0.00	0.08	0.19	0.30	0.41	0.53	0.64	0.76
	Medium	909	904	886	854	810	753	683	600
	Corrected ESP ¹	0.00	0.00	0.10	0.22	0.33	0.46	0.58	0.71
	High	1118	1132	1126	1101	1056	992	908	805
	Corrected ESP ¹	0.00	0.00	0.00	0.09	0.22	0.35	0.49	0.64
*30"36K, B-Cabinet	Low	953	915	871	821	764	701	631	555
	Corrected ESP ¹	0.00	0.04	0.16	0.27	0.39	0.51	0.62	0.74
	Medium	1265	1232	1188	1133	1067	991	903	805
	Corrected ESP ¹	0.00	0.00	0.03	0.15	0.28	0.41	0.54	0.68
	High	1427	1385	1333	1270	1196	1113	1018	913
	Corrected ESP ¹	0.00	0.00	0.00	0.09	0.23	0.36	0.50	0.64
*42K, B-Cabinet	Low	1324	1302	1271	1233	1187	1134	1072	1003
	Corrected ESP ¹	0.00	0.06	0.17	0.27	0.38	0.49	0.61	0.72
	Medium	1485	1455	1418	1373	1320	1260	1193	1118
	Corrected ESP ¹	0.00	0.00	0.13	0.24	0.36	0.47	0.58	0.70
	High	1637	1601	1558	1506	1447	1380	1305	1223
	Corrected ESP ¹	0.00	0.00	0.00	0.21	0.33	0.44	0.56	0.68
*48K, C-Cabinet	Low	1605	1606	1592	1565	1524	1468	1399	1316
	Corrected ESP ¹	0	0.11	0.21	0.31	0.42	0.52	0.63	0.74
	Medium	1977	1939	1890	1830	1758	1675	1590	1474
	Corrected ESP ¹	0	0	0.18	0.28	0.39	0.50	0.61	0.72
	High	2264	2182	2095	2003	1906	1805	1698	1586
	Corrected ESP ¹	0	0	0	0.26	0.37	0.49	0.60	0.71

¹ ESP estimate with wet coil and filter

Notes:

- 1) Airflow is shown in cfm, +/- 5%.
- 2) External static pressure (ESP) is shown in inches w.c.
- 3) See unit nameplate or installation instructions for maximum recommended external static pressure.

	Switch Setting				Cooling or Heating Airflow (CFM)							
					Dry Coil ESP							
	1/5	2/6	3/7	4/8	0.1	0.2	0.3	0.4	0.5	0.6	0.7	0.8
*60K, C-Cabinet	0	0	0	0	710	580	395					
	1	0	0	0	830	690	675	530	505			
	0	1	0	0	930	875	710	665	560	530		
	1	1	0	0	1065	1015	900	840	800	705	665	635
	0	0	1	0	1185	1115	1010	960	925	875	830	745
	1	0	1	0	1275	1220	1175	1120	1060	970	930	890
	0	1	1	0	1365	1350	1255	1200	1150	1105	1060	1025
	1	1	1	0	1480	1430	1370	1325	1265	1225	1185	1140
	0	0	0	1	1560	1535	1485	1430	1375	1335	1285	1240
	1	0	0	1	1650	1600	1545	1500	1450	1405	1360	1305
	0	1	0	1	1730	1685	1660	1610	1570	1520	1470	1420
	1	1	0	1	1785	1740	1695	1645	1615	1545	1510	1470
	0	0	1	1	1865	1820	1785	1750	1695	1655	1605	1560
	1	0	1	1	1920	1890	1850	1805	1765	1715	1675	1640
	0	1	1	1	2010	1965	1960	1900	1850	1810	1775	1730
	1	1	1	1	2065	2020	1985	1955	1915	1880	1840	1810

NOTE: 0 = OFF, 1 = ON

B6BMMX AIR HANDLERS WITH COIL
ELECTRICAL DATA



ELECTRICAL DATA

Cabinet	Capacity	Model Number H8HK-	Voltage 240								Voltage 208							
			Min. Circuit Amp.				Max. Over-current Rating				Min. Circuit Amp.				Max. Over-Current Rating			
			Circuit A	Circuit B	Circuit C	Single Circuit	Circuit A	Circuit B	Circuit C	Single Circuit	Circuit A	Circuit B	Circuit C	Single Circuit	Circuit A	Circuit B	Circuit C	Single Circuit
A	24	None	1.6	-	-	1.6	15.0	-	-	15.0	1.6	-	-	1.6	15.0	-	-	15.0
		005H-XX	26.6	-	-	26.6	30.0	-	-	30.0	23.3	-	-	23.3	25.0	-	-	25.0
		008H-XX	41.2	-	-	41.2	45.0	-	-	45.0	35.9	-	-	35.9	40.0	-	-	40.0
		010H-XX	51.6	-	-	51.6	60.0	-	-	60.0	45.0	-	-	45.0	45.0	-	-	45.0
		009Q-XX	-	-	-	28.7	-	-	-	30.0	-	-	-	18.8	-	-	-	30.0
B	24	None	1.6	-	-	1.6	15.0	-	-	15.0	1.6	-	-	1.6	15.0	-	-	15.0
		005H-XX	26.6	-	-	26.6	30.0	-	-	30.0	23.3	-	0.0	23.3	25.0	-	-	25.0
		008H-XX	41.2	-	-	41.2	45.0	-	-	45.0	35.9	-	-	35.9	40.0	-	-	40.0
		010H-XX	51.6	-	-	51.6	60.0	-	-	60.0	45.0	-	-	45.0	45.0	-	-	45.0
		009Q-XX	-	-	-	28.7	-	-	-	30.0	-	-	-	18.8	-	-	-	30.0
A	30	None	3.1	-	-	3.1	15.0	-	-	15.0	3.1	-	-	3.1	15.0	-	-	15.0
		005H-XX	28.1	-	-	28.1	30.0	-	-	30.0	24.8	-	-	24.8	25.0	-	-	25.0
		008H-XX	42.7	-	-	42.7	45.0	-	-	45.0	37.4	-	-	37.4	40.0	-	-	40.0
		010H-XX	53.1	-	-	53.1	60.0	-	-	60.0	46.5	-	-	46.5	50.0	-	-	50.0
		015H-XX	53.1	25.0	-	65.6	60.0	30.0	-	80.0	46.5	21.7	-	68.1	50.0	25.0	-	70.0
		009Q-XX	-	-	-	30.2	-	-	-	35.0	-	-	-	26.6	-	-	-	30.0
		015Q-XX	-	-	-	46.4	-	-	-	50.0	-	-	-	40.6	-	-	-	45.0
B	30/36	None	2.6	-	-	2.6	15.0	-	-	15.0	2.6	-	-	2.6	15.0	-	-	15.0
		005H-XX	27.6	-	-	27.6	30.0	-	-	30.0	24.3	-	-	24.3	25.0	-	-	25.0
		008H-XX	42.2	-	-	42.2	45.0	-	-	45.0	36.9	-	-	36.9	40.0	-	-	40.0
		010H-XX	52.6	-	-	52.6	60.0	-	-	60.0	46.0	-	-	46.0	50.0	-	-	50.0
		015H-XX	52.6	25.0	-	64.7	60.0	30.0	-	80.0	46.0	21.7	-	69.6	50.0	25.0	-	70.0
		020H-XX	52.6	50.0	-	102.6	60.0	60.0	-	110.0	46.0	43.3	-	89.3	50.0	45.0	-	90.0
		009Q-XX	-	-	-	29.7	-	-	-	30.0	-	-	-	26.1	-	-	-	30.0
		015Q-XX	-	-	-	45.9	-	-	-	50.0	-	-	-	40.2	-	-	-	45.0
B	42	None	3.1	-	-	3.1	15.0	-	-	15.0	3.1	-	-	3.1	15.0	-	-	15.0
		005H-XX	28.1	-	-	28.1	30.0	-	-	30.0	24.8	-	-	24.8	25.0	-	-	25.0
		008H-XX	42.7	-	-	42.7	45.0	-	-	45.0	37.4	-	-	37.4	40.0	-	-	40.0
		010H-XX	53.1	-	-	53.1	60.0	-	-	60.0	46.5	-	-	46.5	50.0	-	-	50.0
		015H-XX	53.1	25.0	-	65.6	60.0	30.0	-	80.0	46.5	21.7	-	68.1	50.0	25.0	-	70.0
		020H-XX	53.1	50.0	-	103.1	60.0	60.0	-	110.0	46.5	43.3	-	89.8	50.0	45.0	-	90.0
		009Q-XX	-	-	-	30.2	-	-	-	35.0	-	-	-	26.6	-	-	-	30.0
		015Q-XX	-	-	-	46.4	-	-	-	50.0	-	-	-	40.7	-	-	-	45.0
C	48	None	5.4	-	-	5.4	15.0	-	-	15.0	5.4	-	-	5.4	15.0	-	-	15.0
		005H-XX	30.4	-	-	30.4	35.0	-	-	35.0	27.0	-	-	27.0	30.0	-	-	30.0
		008H-XX	45.0	-	-	45.0	45.0	-	-	45.0	39.7	-	-	39.7	40.0	-	-	40.0
		010H-XX	55.4	-	-	55.4	60.0	-	-	60.0	48.7	-	-	48.7	50.0	-	-	50.0
		015H-XX	55.4	25.0	-	80.4	60.0	30.0	-	90.0	48.7	21.7	-	70.4	50.0	25.0	-	80.0
		020H-XX	55.4	50.0	-	105.4	60.0	60.0	-	110.0	48.7	43.3	-	92.0	50.0	45.0	-	100.0
		025H-XX	55.4	50.0	25.0	130.4	60.0	60.0	60.0	150.0	48.7	43.3	21.7	113.7	50.0	45.0	45.0	125.0
		030H-XX	55.4	50.0	50.0	155.4	60.0	60.0	60.0	175.0	48.7	43.3	43.3	135.4	50.0	45.0	45.0	150.0
		009Q-XX	-	-	-	32.4	-	-	-	35.0	-	-	-	28.8	-	-	-	30.0
		015Q-XX	-	-	-	48.7	-	-	-	50.0	-	-	-	42.9	-	-	-	45.0
C	60	None	6.3	-	-	6.3	15.0	-	-	15.0	6.8	-	-	6.8	15.0	-	-	15.0
		005H-XX	31.3	-	-	31.3	35.0	-	-	35.0	28.4	-	-	28.4	30.0	-	-	30.0
		008H-XX	45.8	-	-	45.8	50.0	-	-	50.0	41.1	-	-	41.1	45.0	-	-	45.0
		010H-XX	56.3	-	-	56.3	60.0	-	-	60.0	50.1	-	-	50.1	60.0	-	-	60.0
		015H-XX	56.3	25.0	-	81.3	60.0	30.0	-	90.0	50.1	21.7	-	71.8	60.0	25.0	-	80.0
		020H-XX	56.3	50.0	-	106.3	60.0	60.0	-	110.0	50.1	43.3	-	93.4	60.0	45.0	-	100.0
		025H-XX	56.3	50.0	25.0	131.3	60.0	60.0	30.0	150.0	50.1	43.3	21.7	115.1	60.0	45.0	25.0	125.0
		030H-XX	56.3	50.0	50.0	156.3	60.0	60.0	60.0	175.0	50.1	43.3	43.3	136.8	60.0	45.0	45.0	150.0
		009Q-XX	-	-	-	33.3	-	-	-	35.0	-	-	-	30.2	-	-	-	35.0
		015Q-XX	-	-	-	49.6	-	-	-	50.0	-	-	-	44.3	-	-	-	45.0

MB7BM MODULAR AIR HANDLERS
13+ SEER - MULTI-SPEED



**CALL FOR
AVAILABILITY
AND PRICING**

- **Less coil —for a complete air handler, select a blower and a coil with appropriate refrigerant.**
The C7 Series coil is a dimensional match to the MB7 air handler.
- 13+ SEER (†)
- Multi-poised — may be used in horizontal, upflow, downflow and vertical applications
- Multi-speed
- Plug-in heater kits
- Circuit board with blower time delay, low voltage terminal strip and heat strip sequencing
- Control board with field-selectable sequence timing
- 1/2" cabinet insulation
- Plug-in wire connections and modularity
- Breaker accessible from front of unit when heater is applied
- Galvanized steel with polyester urethane finish

RESIDENTIAL WARRANTY

Effective on product manufactured after 7-1-19.

- 3 year parts only to original owner if purchased as a separate item

WHILE SUPPLIES LAST

MODEL IDENTIFICATION CODE

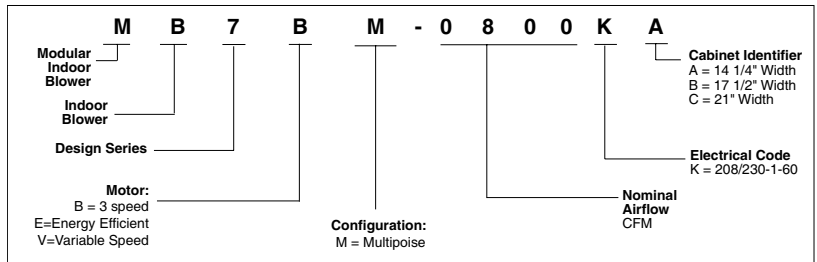

ID ORDER#	MODEL#	SEER(†)	NOM. COOLING BTUH(†)	HP	SPEED	DIMENSIONS W x D x H
655241	MB7BM-1200-KB	13+	36,000	1/3	3	17-1/2" x 22" x 24-3/4"
655243	MB7BM-2000-KC	13+	60,000	3/4	3	21" x 22" x 27-1/2"

FOR BLOWER PERFORMANCE DATA, SEE PAGE 508.7

FOR ELECTRICAL DATA, SEE PAGE 508.10

FOR HEATER KITS & ACCESSORIES, SEE PAGES 508.11

**FOR ADDITIONAL INFORMATION, VISIT
THE NORTEK WEBSITE AT www.nortekhvac.com**

OUTPUT NOTE (†): Output capacity may vary slightly. See Nortek website (www.nortekhvac.com) or current ARI directory (www.ari.org) for certified combinations and ratings.

MB7BM MODULAR AIR HANDLERS
BLOWER PERFORMANCE DATA



		Dry Coil ESP	0.10	0.20	0.30	0.40	0.50	0.60	0.70	0.80
0800 A-Cabinet	Low	685	645	605	565	515	465	405	345	
	<i>Corrected ESP¹</i>		0.07	0.19	0.30	0.42	0.53	0.65	0.76	
	Med	860	825	780	735	680	625	565	500	
	<i>Corrected ESP¹</i>			0.11	0.23	0.36	0.48	0.60	0.72	
	High	1070	1025	975	920	860	800	730	660	
	<i>Corrected ESP¹</i>				0.14	0.27	0.40	0.53	0.67	

		Dry Coil ESP	0.10	0.20	0.30	0.40	0.50	0.60	0.70	0.80
1200 A-Cabinet	Low	850	825	795	755	705	645	580	510	
	<i>Corrected ESP¹</i>		0.04	0.15	0.27	0.38	0.50	0.62	0.74	
	Med	1120	1085	1045	995	940	875	800	715	
	<i>Corrected ESP¹</i>			0.04	0.17	0.29	0.42	0.55	0.68	
	High	1275	1235	1185	1130	1070	1005	935	860	
	<i>Corrected ESP¹</i>				0.10	0.23	0.36	0.49	0.63	

		Dry Coil ESP	0.10	0.20	0.30	0.40	0.50	0.60	0.70	0.80
1200 B-Cabinet	Low	995	955	910	845	780	705	610	530	
	<i>Corrected ESP¹</i>		0.08	0.19	0.31	0.42	0.54	0.65	0.76	
	Med	1335	1290	1235	1175	1100	1015	925	805	
	<i>Corrected ESP¹</i>			0.10	0.22	0.34	0.46	0.59	0.71	
	High	1470	1425	1360	1300	1225	1135	1050	920	
	<i>Corrected ESP¹</i>				0.08	0.22	0.37	0.51	0.65	

		Dry Coil ESP	0.10	0.20	0.30	0.40	0.50	0.60	0.70	0.80
1600 C-Cabinet	Low	1035	1005	970	925	875	825	770	710	
	<i>Corrected ESP¹</i>		0.11	0.22	0.33	0.44	0.54	0.65	0.76	
	Med	1635	1595	1525	1475	1405	1305	1210	1060	
	<i>Corrected ESP¹</i>			0.08	0.20	0.32	0.44	0.57	0.69	
	High	1910	1840	1760	1685	1595	1495	1395	1250	
	<i>Corrected ESP¹</i>				0.14	0.26	0.39	0.52	0.65	

		Dry Coil ESP	0.10	0.20	0.30	0.40	0.50	0.60	0.70	0.80
2000 C-Cabinet	Low	1520	1510	1500	1485	1465	1440	1415	1385	
	<i>Corrected ESP¹</i>		0.11	0.21	0.31	0.42	0.52	0.62	0.72	
	Med	1900	1885	1860	1830	1790	1740	1680	1620	
	<i>Corrected ESP¹</i>		0.06	0.16	0.27	0.37	0.48	0.59	0.70	
	High	2245	2195	2135	2080	2015	1950	1885	1800	
	<i>Corrected ESP¹</i>			0.12	0.23	0.34	0.45	0.56	0.67	

¹ ESP estimate with wet coil and filter

Notes:

- 1) Air flow is shown in CFM, +/- 5%.
- 2) External static pressure (ESP) is shown in inches w.c.
- 3) See unit nameplate or installation instructions for maximum recommended external static pressure.

Information from Nortek Technical Specification #834D-1117

MB7VM MODULAR AIR HANDLERS
13 to 16 SEER - VARIABLE SPEED



- **Less coil —for a complete air handler, select a blower and a coil.** The C7 Series coil is a dimensional match to the MB7 air handler.
- 13 to 16 SEER (†)
- FER compliant
- Variable speed ECM motor
- Multi-poised — may be used in horizontal, upflow, downflow and vertical applications
- Constant airflow
- Reduced air stratification
- Plug-in heater kits
- Circuit board with blower time delay, low voltage terminal strip and heat strip sequencing
- Control board with field-selectable sequence timing
- 1/2" cabinet installation
- Plug-in wire connections and modularity
- Breaker accessible from front of unit when heater is applied
- Polyester urethane finish
- 208/230V, 60 hz, 1 phase



MODEL IDENTIFICATION CODE

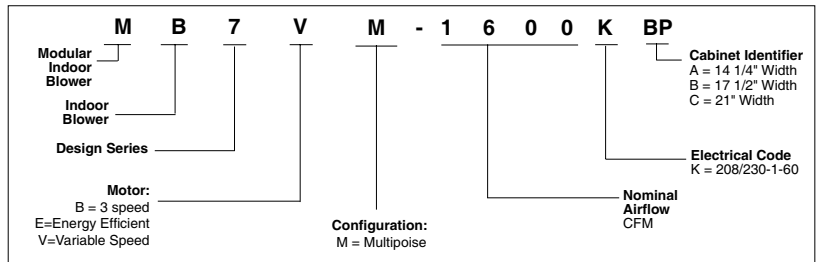

RESIDENTIAL WARRANTY

Effective on product manufactured after 7-1-19.

- 3 year parts only to original owner if purchased as a separate item

ID ORDER#	MODEL#	SEER(†)	NOM. COOLING BTUH(†)	HP	SPEED	DIMENSIONS W x D x H
655252	MB7VM-1200-KAP	13+	36,000	1/2	variable	14-1/4" x 22" x 24-3/4"
655253	MB7VM-1600-KBP	13+	48,000	1/2	variable	17-1/2" x 22" x 24-3/4"
655254	MB7VM-2000-KCP	13+	60,000	1/2	variable	21" x 22" x 27-1/2"

FOR AIRFLOW SELECTIONS, SEE PAGE 508.9
 FOR ELECTRICAL DATA, SEE PAGE 508.10
 FOR HEATER KITS & ACCESSORIES, SEE PAGES 508.11
 FOR ADDITIONAL INFORMATION, VISIT
 THE NORTEK WEBSITE AT www.nortekhvac.com

OUTPUT NOTE (†): Output capacity may vary slightly. See Nortek website (www.nortekhvac.com) or current ARI directory (www.ari.org) for certified combinations and ratings.

MB7VM MODULAR AIR HANDLERS
AIRFLOW SELECTIONS



COOLING AIRFLOW SETTINGS A-CABINET							
CFM	A/B Switch Setting 0 = OFF, 1 = ON	SWITCH SETTINGS 0 = OFF, 1 = ON				NOMINAL CAPACITY	
		1	2	3	4		
525	0	0	0	0	0	1.5 TON	
560	0	0	0	0	1		
600	0	0	0	1	0		
625	0	0	0	1	1		
700	0	0	1	0	0		2 TON
750	0	0	1	0	1		
800	0	0	1	1	0		
850	0	0	1	1	1		
875	0	1	0	0	0		2.5 TON
890	0	1	0	0	1		
930	0	1	0	1	0		
950	0	1	0	1	1		
1000	0	1	1	0	0	3 TON	
1050	0	1	1	0	1		
1125	0	1	1	1	0		
1200	0	1	1	1	1		

Heating Airflow A-Cabinet		
HEAT Switch Setting A/B	Heater Kit Installed (KW)	Air ow (CFM)
0	0	600
0	5	800
0	8	900
0	10	1000
0	15	1300

COOLING AIRFLOW SETTINGS B-CABINET							
CFM	A/B Switch Setting 0 = OFF, 1 = ON	SWITCH SETTINGS 0 = OFF, 1 = ON				NOMINAL CAPACITY	
		1	2	3	4		
525	1	0	0	0	0	1.5 TON	
560	1	0	0	0	1		
600	1	0	0	1	0		
650	1	0	0	1	1		
700	1	0	1	0	0		2 TON
750	1	0	1	0	1		
800	1	0	1	1	0		
850	1	0	1	1	1		
875	1	1	0	0	0		2.5 TON
950	1	1	0	0	1		
1050	1	1	0	1	0		
1150	1	1	0	1	1	3 TON	
1250	1	1	1	0	0		
1350	1	1	1	0	1	3.5 TON	
1400	1	1	1	1	0		
1600	1	1	1	1	1	4 TON	

Heating Airflow B-Cabinet		
HEAT Switch Setting A/B	Heater Kit Installed (KW)	Air ow (CFM)
1	0	700
1	5	900
1	8	1000
1	10	1100
1	15	1300
1	20	1500

COOLING AIRFLOW SETTINGS C-CABINET						
CFM	A/B Switch Setting 0 = OFF, 1 = ON	SWITCH SETTINGS 0 = OFF, 1 = ON				NOMICAL CAPACITY
		1	2	3	4	
1100	*	0	0	0	0	3 TON
1200	*	0	0	0	1	
1250	*	0	0	1	0	3.5 TON
1300	*	0	0	1	1	
1350	*	0	1	0	0	
1400	*	0	1	0	1	4 TON
1450	*	0	1	1	0	
1500	*	0	1	1	1	5 TON
1550	*	1	0	0	0	
1600	*	1	0	0	1	
1650	*	1	0	1	0	
1700	*	1	0	1	1	
1750	*	1	1	0	0	
1800	*	1	1	0	1	
1900	*	1	1	1	0	
2000	*	1	1	1	1	

Heating Airflow C-Cabinet		
HEAT Switch Setting A/B	Heater Kit Installed (KW)	Air ow (CFM)
*	0	800
*	5	1000
*	8	1100
*	10	1200
*	15	1400
*	20	1600

NOTES:

Air ow values listed are for 240V operation. For 208V operation, multiply A & B cabinet values by .95; for C-cabinet values multiply by .90

* = either 0 or 1

0 = OFF, 1 = ON

Information from Nortek Technical Specification #834D-1117

NORTEK

MB7 MODULAR AIR HANDLERS

ELECTRICAL DATA



Model	Cabinet	Capacity	Model Number H8HK-	Voltage 240								Voltage 208								
				Min. Circuit Amp.				Max. Over-current Rating				Min. Circuit Amp.				Max. Over-Current Rating				
				Circuit A	Circuit B	Circuit C	Single Circuit	Circuit A	Circuit B	Circuit C	Single Circuit	Circuit A	Circuit B	Circuit C	Single Circuit	Circuit A	Circuit B	Circuit C	Single Circuit	
MB7BM	A	800CFM	None	1.6	-	-	1.6	15.0	-	-	15.0	1.6	-	-	1.6	15.0	-	-	15.0	
			005H-XX	26.6	-	-	26.6	30.0	-	-	30.0	23.3	-	-	23.3	25.0	-	-	25.0	
			008H-XX	41.2	-	-	41.2	45.0	-	-	45.0	35.9	-	-	35.9	40.0	-	-	40.0	
			010H-XX	51.6	-	-	51.6	60.0	-	-	60.0	45.0	-	-	45.0	45.0	-	-	45.0	
	B	1200CFM	None	2.6	-	-	2.6	15.0	-	-	15.0	2.6	-	-	2.6	15.0	-	-	15.0	
			005H-XX	27.6	-	-	27.6	30.0	-	-	30.0	24.3	-	-	24.3	25.0	-	-	25.0	
			008H-XX	42.2	-	-	42.2	45.0	-	-	45.0	36.9	-	-	36.9	40.0	-	-	40.0	
			010H-XX	52.6	-	-	52.6	60.0	-	-	60.0	46.0	-	-	46.0	50.0	50.0	-	45.0	
			015H-XX	52.6	25.0	-	64.7	60.0	30.0	-	80.0	46.0	21.7	-	67.6	50.0	25.0	-	70.0	
			020H-XX	52.6	50.0	-	102.6	60.0	60.0	-	110.0	46.0	43.3	-	89.3	50.0	45.0	-	90.0	
	C	1600CFM	None	3.1	-	-	3.1	15.0	-	-	15.0	3.1	-	-	3.1	15.0	-	-	15.0	
			005H-XX	28.1	-	-	28.1	30.0	-	-	30.0	24.8	-	-	24.8	25.0	-	-	25.0	
			008H-XX	42.7	-	-	42.7	45.0	-	-	45.0	37.4	-	-	37.4	40.0	-	-	40.0	
			010H-XX	53.1	-	-	53.1	60.0	-	-	60.0	46.5	-	-	46.5	50.0	-	-	50.0	
			015H-XX	53.1	-	-	65.6	60.0	-	-	80.0	46.5	21.7	-	68.1	50.0	25.0	-	70.0	
			020H-XX	53.1	-	-	103.1	60.0	-	-	110.0	46.5	43.3	-	89.8	50.0	45.0	-	90.0	
	C	2000CFM	None	5.0	-	-	5.0	15.0	-	-	15.0	5.0	-	-	5.0	15.0	-	-	15.0	
			005H-XX	30.0	-	-	30.0	35.0	-	-	35.0	26.7	-	-	26.7	30.0	-	-	30.0	
			008H-XX	44.6	-	-	44.6	45.0	-	-	45.0	39.3	-	-	39.3	40.0	-	-	40.0	
			010H-XX	55.0	-	-	55.0	60.0	-	-	60.0	48.3	-	-	48.3	50.0	-	-	50.0	
			015H-XX	55.0	25.0	-	80.0	60.0	30.0	-	80.0	48.3	21.7	-	70.0	50.0	25.0	-	70.0	
			020H-XX	55.0	50.0	-	105.0	60.0	60.0	-	110.0	48.3	43.3	-	91.7	50.0	45.0	-	100.0	
	MB7(E,V)M	A	1200CFM	None	4.5	-	-	4.5	15.0	-	-	15.0	4.8	-	-	4.8	15.0	-	-	15.0
				005H-XX	29.5	-	-	29.5	30.0	-	-	30.0	26.4	-	26.4	24.8	30.0	-	-	30.0
008H-XX				44.1	-	-	44.1	45.0	-	-	45.0	39.1	-	-	39.1	40.0	-	-	40.0	
010H-XX				54.5	-	-	54.5	60.0	-	-	60.0	48.1	-	-	48.1	50.0	-	-	50.0	
015H-XX				54.5	50.0	-	68.1	60.0	30.0	-	80.0	48.1	21.7	-	69.8	50.0	25.0	-	70.0	
B		1600CFM	None	4.5	-	4.5	5.4	15.0	-	-	15.0	4.8	-	-	4.8	15.0	-	-	15.0	
			005H-XX	29.5	-	-	29.5	30.0	-	-	30.0	26.4	-	-	26.4	30.0	-	-	30.0	
			008H-XX	44.1	-	-	44.1	45.0	-	-	45.0	39.1	-	-	39.1	40.0	-	-	40.0	
			010H-XX	54.5	50.0	50.0	54.5	60.0	-	-	60.0	48.1	-	-	48.1	50.0	-	-	50.0	
			015H-XX	54.5	-	-	68.1	60.0	-	-	80.0	48.1	-	-	69.8	50.0	-	-	70.0	
			020H-XX	54.5	50.0	-	104.5	60.0	60.0	-	110.0	48.1	43.3	-	91.4	50.0	45.0	-	100.0	
C		2000CFM	None	6.3	-	-	6.3	15.0	-	-	15.0	6.8	-	-	6.8	15.0	-	-	15.0	
			005H-XX	31.3	-	-	31.3	35.0	-	-	35.0	28.4	-	-	28.4	30.0	-	-	30.0	
			008H-XX	45.8	-	-	45.8	50.0	-	-	50.0	41.1	-	-	41.1	45.0	-	-	45.0	
			010H-XX	56.3	-	-	56.3	60.0	-	-	60.0	50.1	-	-	50.1	60.0	-	-	60.0	
			015H-XX	56.3	-	-	81.3	60.0	-	-	90.0	50.1	-	-	71.8	60.0	-	-	80.0	
			020H-XX	56.3	-	-	106.3	60.0	-	-	110.0	50.1	-	-	93.4	60.0	-	-	100.0	

Information from Nortek Technical Specification #834D-1117

NORTEK COIL & AIR HANDLER ACCESSORIES



ID ORDER#	MODEL#	NORTEK#	DESCRIPTION	* = SPECIAL ORDER ITEM
--------------	--------	---------	-------------	------------------------

1 PHASE HEATER KITS WITH CIRCUIT BREAKERS

697947 *	H8HK005H-11	922521	HEATER KIT <u>WITH</u> CIRCUIT BREAKERS—4.8KW , 1-phase, 240 V
698794 *	H8HK008H-11	922523	Same as above, but 7.5KW
698795	H8HK010H-11	922526	Same as above, but 9.6KW
697826	H8HK015H-21	922527	Same as above, but 14.4KW
967830	H8HK020H-21	922529	Same as above, but 19.2KW
698797	H8HK024H-31	922530	Same as above, but 24.0KW

1 PHASE HEATER KITS WITHOUT CIRCUIT BREAKERS

697946 *	H8HK005H-01	922520	HEATER KIT <u>WITHOUT</u> CIRCUIT BREAKERS—4.8KW , 1-phase, 240 V
698792 *	H8HK008H-01	922522	Same as above, but 7.5KW
698791 *	H8HK010H-01	922525	Same as above, but 9.6KW

CIRCUIT ADAPTER

465614 *	913874	--	SINGLE CIRCUIT ADAPTER , for two circuit breakers
----------	--------	----	--

TXV VALVES

635397	920668A	--	TXV VALVE , R-410A, 2.0 ton
634751	920669A	--	Same as above, but 2.5 ton
635398	920670A	--	Same as above, but 3.0 ton
635399	920671A	--	Same as above, but 3.5 ton
635400	920672A	--	Same as above, but 4.0 ton
635401	920673A	--	Same as above, but 5.0 ton

FOR ELECTRICAL DATA, SEE PAGE 508.10

**FOR ADDITIONAL INFORMATION, VISIT
THE NORTEK WEBSITE AT www.nortekhvac.com**

240V Single-Phase Heater Kit Application

Nominal KW	Matched Units					Order Number	
	*800-A	*1200-A	*1200/1600-B	*1600-C	*2000-C	With Circuit Breakers	Without Circuit Breakers
5	X	X	X	X	X	904407	904406
8	X	X	X	X	X	904409	904408
10	X	X	X	X	X	904412	904411
15	n/a	X	X	X	X	904414	n/a
20	n/a	n/a	X	X	X	904416	n/a

240V Three-Phase Heater Kit Application

Nominal KW	Matched Units					Order Number	
	*800-A	*1200-A	*1200/1600-B	*1600-C	*2000-C	With Circuit Breakers	Without Circuit Breakers
9	X	X	X	X	X	904410	n/a
15	n/a	X	X	X	X	904415	n/a

LINESETS

C x C and FLARE

ID ORDER#	LIQUID	SUCTION	INSULATION	DESCRIPTION
C x C LINESETS for split systems				
(Note: Only the suction line is insulated.)				
731564	3/8"	3/4"	3/4"	15' C x C LINESET , copper tube, for use with split system air conditioning and heat pumps
731565	3/8"	3/4"	3/4"	25' C x C LINESET , copper tube, for use with split system air conditioning and heat pumps
731574	3/8"	7/8"	3/4"	<i>Same as above</i>
731584	3/8"	1-1/8"	3/4"	<i>Same as above</i>
731570	3/8"	3/4"	3/4"	35' C x C LINESET , copper tube, for use with split system air conditioning and heat pumps
731576	3/8"	7/8"	3/4"	<i>Same as above</i>
731572	3/8"	3/4"	3/4"	50' C x C LINESET , copper tube, for use with split system air conditioning and heat pumps
731577	3/8"	7/8"	3/4"	<i>Same as above</i>
731585	3/8"	1-1/8"	3/4"	<i>Same as above</i>
FLARE LINESETS for ductless mini-split systems				
(Note: Both lines are insulated.)				
731586	1/4"	3/8"	3/4"	25' C x C LINESET WITH NUT , copper tube, for use with ductless mini-split systems
731589	1/4"	1/2"	3/4"	<i>Same as above</i>
731591	1/4"	5/8"	3/4"	<i>Same as above</i>
731593	3/8"	5/8"	3/4"	<i>Same as above</i>
731588	1/4"	3/8"	3/4"	50' C x C LINESET WITH NUT , copper tube, for use with ductless mini-split systems
731590	1/4"	1/2"	3/4"	<i>Same as above</i>
731592	1/4"	5/8"	3/4"	<i>Same as above</i>
731594	3/8"	5/8"	3/4"	<i>Same as above</i>

ID ORDER#	VENDOR PART #	MODEL #	NOM. CAP. R-22/R-410A (TONS)	TYPE	DESICCANT (CU. IN.)	INLET CONNECTION SIZE (IN.)	CONNECTION
LIQUID LINE DRIERS FOR A/C ONLY — FLARE TYPE							
* = SPECIAL ORDER ITEM							
170866	A18184	FL-032	2.0	Flare	3 cu. in.	1/4" SAE	1/4" SAE
46996 *	A18186	FL-052	2.0	Flare	5 cu. in.	1/4" SAE	1/4" SAE
170868	A18187	FL-053	4.0	Flare	5 cu. in.	3/8" SAE	3/8" SAE
 170869 *	A18188	FL-082	2.0	Flare	8 cu. in.	1/4" SAE	1/4" SAE
46997	A18189	LLD083	1.0-5.0	Flare	8 cu. in.	3/8" SAE	3/8" SAE
170870	A18190	LLD084	1.0-7.0	Flare	8 cu. in.	1/2" SAE	1/2" SAE
170871	A18191	FL-162	2.0	Flare	16 cu. in.	1/4" SAE	1/4" SAE
170872	A18192	LLD163	4.8	Flare	16 cu. in.	3/8" SAE	3/8" SAE
46998 *	A18193	FL-164	9.5-10.0	Flare	16 cu. in.	1/2" SAE	1/2" SAE
170873	A18195	FL-303	4.5	Flare	30 cu. in.	3/8" SAE	3/8" SAE
170874 *	A18196	FL-304	10.0	Flare	30 cu. in.	1/2" SAE	1/2" SAE
170875	A18197	FL-305	14.0	Flare	30 cu. in.	5/8" SAE	5/8" SAE

LIQUID LINE DRIERS FOR A/C ONLY — SOLDER TYPE

170878 *	A18598	SD-032	2.0	Solder	3 cu. in.	1/4" ODF	1/4" ODF
170879	A18599	SD-033	3.9	Solder	3 cu. in.	3/8" ODF	3/8" ODF
170880	A18654	LLD052S	.5-1.5	Solder	5 cu. in.	1/4" ODF	1/4" ODF
170881	A18655	SD-053	4.0	Solder	5 cu. in.	3/8" ODF	3/8" ODF
 170882	A18656	SD-082	2.0	Solder	8 cu. in.	1/4" ODF	1/4" ODF
170883	A18657	LLD083S	1.0-5.0	Solder	8 cu. in.	3/8" ODF	3/8" ODF
170884	A18658	LLD084S	1.0-7.0	Solder	8 cu. in.	1/2" ODF	1/2" ODF
27279	A18699	LLD163S	1.0-5.0	Solder	16 cu. in.	3/8" ODF	3/8" ODF
170885	A18700	LLD164S	2-7.5	Solder	16 cu. in.	1/2" ODF	1/2" ODF
27031 *	A18701	SD-165	14.0	Solder	16 cu. in.	5/8" ODF	5/8" ODF
170886	A18741	SD-303	5.0	Solder	30 cu. in.	3/8" ODF	3/8" ODF
170887	A16659	LLD304S	4.0-8.0	Solder	30 cu. in.	1/2" ODF	1/2" ODF
170888 *	A18743	SD-305	16.0	Solder	30 cu. in.	5/8" ODF	5/8" ODF
170889 *	A18744	SD-307	21.5	Solder	30 cu. in.	7/8" ODF	7/8" ODF
170890 *	A18747	SD-414	11.5	Solder	41 cu. in.	1/2" ODF	1/2" ODF
170891 *	A18748	SD-415	17.0	Solder	41 cu. in.	5/8" ODF	5/8" ODF

LIQUID LINE DRIERS FOR HEAT PUMPS — SOLDER TYPE, BI-DIRECTIONAL

570375	A19004	HPS-163	5.8	Solder	16 cu. in.	3/8" ODF	3/8" ODF
--------	--------	---------	-----	--------	------------	----------	----------

LINE FILTER DRIERS — SUCTION TYPE

170896	A17228	SSLD166S	1-3.25	Suction	16 cu. in.	3/4" ODF	3/4" ODF
170897	A17229	SSLD167S	1-3.5	Suction	16 cu. in.	7/8" ODF	7/8" ODF

ID ORDER#	VENDOR PART#	MODEL #	DESCRIPTION
--------------	-----------------	---------	-------------

SIGHT GLASS INDICATORS

170899	918727	LDE-3S	MOISTURE/SIGHT GLASS INDICATOR , reversible colors, permits easy viewing of bubbles which may indicate pressure drop or a low charge in the system, 3/8" ODF
170900	918728	LDE-4S	<i>Same as above</i> , but 1/2" ODF

REFRIGERATION and A/C ACCESSORIES

ID ORDER#	MODEL #	DESCRIPTION
727088	CS6	"CONDENS SAFE" CONDENSATE NEUTRALIZER BOX
727089	CSM-2	"CONDENS SAFE" CONDENSATE NEUTRALIZER MEDIA , 2 lb. bag
674886	FT800FN	CPS R-410A CLUTCH-DRIVEN FLARING TOOL , with ratchet and case, for 3/16", 1/4", 5/16", 3/8", 1/2", 5/8" and 3/4" O.D. tubing
175542	TG007	ESP TOMMY GUN SPAYER , 2 quart capacity
466806	R-410A	FREON REFRIGERANT—25#
764351	R-438A (MO99)	FREON REFRIGERANT—25# (=R-22)
26870	R-22	FREON REFRIGERANT—30#
47311	RCYL100	FREON RECOVERY CYLINDER—125# , less float
153378	95120	HANDY FLO 6% SILVER SOLDER , 28 rods, 1 lb. (=Harris #D6201F1)
you153379	95150	SIL-FOS 15% SILVER SOLDER , 28 rods, 1 lb. (=Harris #15620F1)
32821	96010	SILVABRITE SOLDER , 1/8" x 1 pound, 4% silver and 96% tin solder (=Harris #SB861)
32820	75108	SILVABRITE PASTE SOLDER FLUX , 4 oz. (=Harris #SCPF4)
153386	75014	ULTRA FLUX , 7 ounce (=Harris #SSWF7)

AIREX LINESET COVERS



- Meets mandatory building codes, energy, residential, mechanical and green codes
- 6 foot lengths
- Black color
- Outdoor UV/weather grade resistant construction
- Self-gripping, dual-bonded hook and loop fastening system
- Removable/reusable for maintenance
- Protector and Class II vapor retarder (all-in-one)
- Meets ASTM G153 weatherization and UV
- Meets ASTM E-96 water/vapor permeability



ID ORDER#	MODEL#	DESCRIPTION
746628	72C-B	E-FLEX GUARD LINESET COVER , 3/4" x 6', 9-1/2" width, fits 3/4" wall thickness pipe insulation with 5/8", 3/4" or 7/8" tube or 1/2" wall thickness pipe insulation with 1-1/8" tube
746629	72X-B	Same as above, but 11-1/2" width and fits 1" wall thickness pipe insulation with 3/4", 7-8" or 1-1/8" tube or 3/4" wall thickness pipe insulation with 1-1/8" tube

**FOR ADDITIONAL INFORMATION, VISIT
THE AIREX WEBSITE AT www.airexmfg.com**

COVER GUARD LINESET DUCT & FITTINGS



- Used with minisplit, high velocity and conventional split air conditioning systems
- Weather resistant PVC, UV stabilized and fire resistant
- Temperature range of -4°F to 140°F
- Paintable
- Expandable

ID ORDER#	MODEL#	DESCRIPTION	CTN QTY
LINESET DUCT			
769423	CGDUC78	LINESET DUCT , 4-1/2" width x 78" length	6
FITTINGS FOR 4-1/2"W DUCT			
769432	CGFLXA	ADAPTER—FLEXIBLE , white	6
769425	CGCUP	COUPLER , white	6
769424	CGFLXLR	ELBOW—90° FLEXIBLE , white (Note: requires 2 CGFLXA adapters per elbow)	6
769427	CG90	ELBOW—90° FLAT , white	6
781313	CGINT90	ELBOW—90° INSIDE , white, for 4.5"W	6
781312	CGEXT90	ELBOW—90° OUTSIDE , white, for 4.5"W	6
775732	CG45	ELBOW—45° FLAT , white	6
769426	CGEND	END FITTING , white	6
769430	CGSTI	SOFFIT INLET , white	6
769428	CGTEE	TEE , white	6
769429	CGINLT	WALL INLET , white	6

**FOR ADDITIONAL INFORMATION, VISIT THE
RECTORSEAL WEBSITE AT www.rectorseal.com**

SEPTEMBER 2024

Line #2990

FORTRESS LINESET DUCT & FITTINGS

512.1



- Used with minisplit, high velocity and conventional split air conditioning systems
- Weather resistant PVC, UV stabilized and fire resistant
- Temperature range of -4°F to 140°F
- Paintable

WHILE SUPPLIES LAST

ID ORDER#	MODEL#	DESCRIPTION	CTN QTY
LINESET DUCT			
733050	LD122W	LINESET DUCT , 4-1/2" width x 96" length	6
FITTINGS			
733065	LFJ122W (84109)	ADAPTER—FLEXIBLE , white	6
733051	LJ122W (84110)	COUPLER , white	6
733066	LDC (84099)	DUCT CLIP—TWISTLOCK	50
733064	LF122W (84108)	ELBOW—90° FLEXIBLE , white	6
733057	LK122W (84111)	ELBOW—90° FLAT , white	6
733053	LEN122W (84107)	END FITTING , white	6
733058	LP122W (84114)	SOFFIT INLET , white	6
733063	LT122W (84115)	TEE , white	6
733052	LW122W (84116)	WALL INLET , white	6

FOR ADDITIONAL INFORMATION, VISIT THE RECTORSEAL WEBSITE AT www.rectorseal.com

DIVERSITECH

REFRIGERATION ACCESSORIES



ID ORDER#	MODEL#	DESCRIPTION
721967	ACB-36	A/C MOUNTING BRACKET , 36", 600# load rating, 2/pack
715516	ACB-42	Same as above, but 42"
742866	ACB-48	Same as above, but 48"
774592	EL4040-3	A/C PAD , 40" x 40" x 3"
170833	ATK-4	ACID TEST KIT (ONE-STEP) , for refrigeration oil, requires only 1/4 the amount of oil sample normally needed, no chemical pre-mix
721489	5381	CABLE CLAMP—NYLON , fits 1/8" pipe outer diameter, 54/pack
721490	5382	Same as above, but fits 1/4" pipe outer diameter and 48/pack
726934	5383	Same as above, but fits 3/8" pipe outer diameter and 41/pack
723271	B-505	CHIP BRUSH , 3", disposable
442214	CVENT-2	CONCENTRIC VENT , 2"
442213	CVENT-3	Same as above, but 3"
714453	CVENT-4	Same as above, but 4"
212515	6-3660S	CONDENSATE DRAIN PAN—A/C SECONDARY , 36" x 60" bottom dimension, 38" x 62" overall dimension, 2" depth, drain line outlets in short side; rolled edges, ribbed bottom and reinforced corners for strength and durability; seamless; 3/4" PVC fittings attached to each pan
170829	VCR-1	CORE REMOVER & STORER , all-steel valve remover and storage container, completely knurled for easier grip, storage compartment for storing extra valve cores, four replacement cores included in each tool
721225	DDS-30	DISCONNECT SWITCH—30 AMP FUSIBLE , with metal case, fuses in pull-out handle, side door opens more than 180 degrees and has a full dead front; reversible door opens to left or right; line, load and ground terminals are aligned for ease of wiring; indicator lights for blown fuses; rain tight and sleet resistant; UL listed, NEMA Type 3R
721226	DDS-60	Same as above, but 60 amp
155108	EDS-60U	DISCONNECT—60 AMP NON-FUSIBLE , low profile with metal case, side opening with a full dead front; rain tight and sleet resistant, UL listed, NEMA Type 3R, 240V
734318	710-102	DUCT STRAP , black, 3" x 100 yards, high tensile, abrasion and chemical resistant
170831	T-300	FIN COMB TOOL , all metal, long lasting, straightens and cleans condenser and evaporator fins, one tool for all units, heavy-duty spring wire bristles automatically adjust to all fin spacings, tension adjustment band allows maximum rigidity and ease of operation, straightens most severely damaged fins
170830	VC-4	FLARE CAP—1/4" , SAE male flare access port, package of 12

FOR ADDITIONAL INFORMATION, VISIT THE DIVERSITECH WEBSITE AT www.diversitech.com

DIVERSITECH

REFRIGERATION ACCESSORIES



ID ORDER#	MODEL#	DESCRIPTION
46333	02053	FREON RECOVERY CYLINDER—50# , less float
740628	7-CRNR20	FUSE—DUAL ELEMENT/TIME DELAY , 20 amp
740630	7-CRNR25	Same as above, but 25 amp
712033	7-CRNR30	Same as above, but 30 amp
740622	7-CRNR35	Same as above, but 35 amp
740623	7-CRNR40	Same as above, but 40 amp
764307	7-CRNR45	Same as above, but 45 amp
740624	7-CRNR50	Same as above, but 50 amp
740625	7-CRNR60	Same as above, but 60 amp
155113	DST-6	HARD START KIT—TORQUE PLUS , specially-designed relay and large start capacitor for severe low voltage or hard starting compressors; increases starting torque up to 500%; installs in seconds across run capacitor terminals; for all PSC A/C units from 4,000-120,000 BTU's (1/2-10 hp); can be used on 120-288 VAC units; UL listed
172344	BNT-32	LEAK DETECTOR (BUBBLE-N-TROUBLE) , 1 quart with spray top, high bubbling, high viscosity blue leak detector, will freeze at 32°F, non-toxic, oxygen safe, non-corrosive
6793	710-182G	MECHANIC'S WIRE , 18 gauge galvanized, 2 lb. reel
650643	EL2424-3	PAD—A/C , 3" depth, for condensing units, 24" x 24"
780610	EL2436-3	Same as above, but 24" x 36"
650644	EL3232-3	Same as above, but 32" x 32"
718315	EL3636-3	Same as above, but 36" x 36"
10701	MP-3C	PAD—ANTI-VIBRATION , type A, 3"x3"x7/8"
445352	626-15T	PLUG FUSE—TIME DELAY , 15 amp, type "T"
10035	M-1	POCKET MIRROR—CIRCULAR TELESCOPING , 1-1/4" in diameter, extends to 18-3/4"
617591	PF-KIT	PRO-FLUSH FLUSH KIT , including charging hose, large flush nozzle, refillable pressure tank, 16 oz. Pro-Flush solvent and pressure relief valve (=Rectorseal #82500)
617592	PF-16	PRO-FLUSH SOLVENT , 16 ounces (=Rectorseal #82400)

FOR ADDITIONAL INFORMATION, VISIT THE DIVERSITECH WEBSITE AT www.diversitech.com

DIVERSITECH

REFRIGERATION ACCESSORIES



ID ORDER#	MODEL#	DESCRIPTION
715025	QSWI3000	QUICK-SLING FLUSH MOUNT WITH H BRACKET , 360° rotation
711540	944KIT	SEALANT—CLIPLIGHT SUPER SEAL , for 1.5 to 5 tons
155104	6-202-1	SEALING COMPOUND—DIVERSIGUM (“THUM-GUM”) , non-hardening putty, 1 lb. bag (does not contain asbestos)
155105	6-202-2	<i>Same as above</i> , but 2 lb. bag
732760	995	SEALANT—FLEX INJECT TOTAL , with UV dye for systems up to 6 tons; seals and prevents minor A/C and refrigeration leaks; for use in aluminum and copper coils; microchannel friendly
170828	14145	SMOKE EMITTER CARTRIDGE , 45 second burn time, 150 cubic feet
445730	ET33	TAPE—ELECTRICAL , 3/4” x 66’, 3M premium grade, 7 mil thick, all weather, 0-220°F temperature range, resealable plastic case
155106	6-330	TAPE—INSULATION—30’ CORK , black, 1/8” x 2” roll, adheres to all metals, can be used on hot or cold pipes, will not dry or crack, stops condensation and drips
155107	6-9718	TAPE—INSULATION—30’ FOAM , black, 1/8” x 2” roll, self-adhesive, can be used on hot or cold pipes, easily cut and molded, works well around valves and fittings
41484	7-12P	TUBING—CLEAR VINYL “GORILLA TUBE” , 1/2” ID x 100’ vinyl chloride tubing, extra rigid design, maximum service temperature of 140°F
33931	7-38P	<i>Same as above</i> , but 3/8” ID
54470	7-58P	<i>Same as above</i> , but 5/8” ID
170837	VP68-32	VACUUM PUMP OIL , recommended for those applications requiring straight mineral paraffinic oil; in service, provides low carbon residue and good water separating capability, 1 quart
170836	VP68-01	<i>Same as above</i> , but 1 gallon

FOR ADDITIONAL INFORMATION, VISIT THE DIVERSITECH WEBSITE AT www.diversitech.com

DIVERSITECH

REFRIGERATION ACCESSORIES



ID ORDER#	MODEL#	DESCRIPTION
155953	WS-1	WET SWITCH FLOOD DETECTOR , solid state control turns system off when detecting moisture due to condensate or drain leaks, 24V, 2 amp, 3-wire installation, LED indicator, may connect more than one unit to a system, re-set by drying the absorbent pad with a paper towel and momentarily interrupting the power
755966	623-002	WIRE NUT CONNECTOR—BLUE , size 72B #22 to #14 AWG, 100/pkg
755967	623-003	Same as above, but <u>orange</u> and size 73B #22 to #14 AWG
755968	623-004	Same as above, but <u>yellow</u> and size 74B #22 to #14 AWG
175199	WTB07C	WIRE TIE—BLACK NYLON , 7", weather-resistant, 50 lb. tensile strength strength, 100 per package, sold by package only
713592	WTB11C	Same as above, but 11"
155109	6-12-4NM	WHIP—1/2" x 4' , #10 THHN wire, 2-straight connect, pre-assembled, includes (2) electrical reducing washers, color-coded wire for easy hookup
155110	6-12-6NM	Same as above, but 1/2" x 6"
155111	6-34-4NM	Same as above, but 3/4" x 4' and #8 THHN wire
155112	6-34-6NM	Same as above, but 3/4" x 6' and #8 THHN wire

FOR ADDITIONAL INFORMATION, VISIT THE DIVERSITECH WEBSITE AT www.diversitech.com



ID	ORDER#	MODEL#	DESCRIPTION
	713146	CR4X370	CAPACITOR—OVAL RUN , 4 MFD, 370V, 2-1/8"W x 1-1/4"D x 2"H
	713147	CR5X370	Same as above, but 5 MFD
	712040	CR7.5X370	Same as above, but 7.5 MFD
	710940	CR10X370	Same as above, but 10 MFD and 2-3/4"W x 1-1/4"D x 2"H
	713169	CR12.5X370	Same as above, but 12.5 MFD
	713625	CR15X370	Same as above, but 15 MFD and 3-1/8"W x 1-1/4"D x 2"H
	743903	CR20X370	Same as above, but 20 MFD and 2-5/8"W x 1-3/4"D x 2-13/16"H
	713626	CR40X370	Same as above, but 40 MFD and 3-5/8"W x 1-3/4"D x 2-13/16"H
713082	CR20X370R	CAPACITOR—ROUND RUN , 20 MFD, 370V, 1-3/4" x 2-3/4"	
	713151	CD25+5X440R	CAPACITOR—ROUND DUAL RUN , 25/5 MFD, 440V
	710933	CD30+5X440R	Same as above, but 30/5 MFD
	710936	CD35+5X440R	Same as above, but 35/5 MFD
	756569	CD35+7.5X440R	Same as above, but 35/7.5 MFD
	710937	CD40+5X440R	Same as above, but 40/5 MFD
	756570	CD40+7.5X440R	Same as above, but 40/7.5 MFD
	710938	CD45+5X440R	Same as above, but 45/5 MFD
	710939	CD50+5X440R	Same as above, but 50/5 MFD
	756134	CD50+7.5X440R	Same as above, but 50/7.5 MFD
	713150	CD55+5X440R	Same as above, but 55/5 MFD
	756132	CD55+7.5X440R	Same as above, but 55/7.5 MFD
	711956	CD60+5X440R	Same as above, but 60/5 MFD
	713357	LCD65+5X440R	Same as above, but 65/5 MFD (= CD65+5X440R)
713148	CD70+5X440R	Same as above, but 70/5 MFD	
721245	SPCP115	CONDENSATE PUMP WITH SAFETY SWITCH , 115V	
	713227	DP25242	CONTACTOR , 2 pole, 25A, 24V
	711954	DP30242	Same as above, but 30A
	712012	DP40242	Same as above, but 40A
713660	SUD109	COPPER DRIER	
	713797	DB8	DUCT BOOSTER , 8" x 8", 115V, 60 Hz
	713144	FC4011	FAN CENTER , 120V
713796	90380	FAN RELAY , NO/NC, 24V	

FOR ADDITIONAL INFORMATION, VISIT THE SUPCO WEBSITE AT www.supco.com

SUPCO HVAC ACCESSORIES



	ID ORDER#	MODEL#	DESCRIPTION
	713618	90293	FAN RELAY , SPDT, 24V
	713795	90370	Same as above, but form "C" contact 8FLA
	713794	90290	FAN RELAY , SPST, 24V
	713793	90292	Same as above, but 240V
	713787	HP083S	FILTER DRIER—HEAT PUMP LIQUID LINE BI-DIRECTIONAL , 3/8" ODF, 600 PSIG, 6.3"L x 2.5"W x 2.5"H
	713788	HP163S	Same as above, but 7"L x 3"W x 2.5H
	170880	LLD052S	FILTER DRIER—LIQUID LINE , 1/4" solder, 3.1 ton R410A/R22,
	46997	LLD083	Same as above, but 3/8" flare, 1-5 ton
	170883	LLD083S	Same as above, but 3/8" solder, 4.6 ton
	170870	LLD084	Same as above, but 1/2" flare, 1-7 ton
	170884	LLD084S	Same as above, but 1/2" solder, 7.6 ton
	170872	LLD163	Same as above, but 3/8" flare, 4.8 ton
	27279	LLD163S	Same as above, but 3/8" solder, 5.3 ton
	170885	LLD164S	Same as above, but 1/2" solder, 2-7.5 ton
	713786	LLD165S	Same as above, but 5/8" solder, 14.2 ton
	170887	LLD304S	Same as above, but 1/2" solder, 4-8 ton
		170896	SSLD166S
	170897	SSLD167S	Same as above, but 7/8" ODF
	711428	IG402K	FURNACE IGNITER—UNIVERSAL
	768982	1G406	Same as above, but with leads and wire nuts, =Weil-McLain #511-330-148, and #511-330-188, Robert Shaw #41-406, and Honeywell #Q4100C9050
	752016	SIG101	FURNACE IGNITER , =Nortek #902661A and #902661
	739949	SIG104	Same as above, but =Nortek #903110A and #903110
	713321	3W1	HARDSTART KIT , 1-3 HP, voltage sensing, instant re-start, 35 amp relay contacts, 208-277 VAC, 330 VAC start capacitor, EZ snap bracket
	713322	3W2	Same as above, but 3.5-4.5 HP
	713791	3W3	Same as above, but 4-5 HP
	712786	SPP6	HARDSTART KIT
	713386	RCO210	HARDSTART KIT—3-1
	713646	SPP5	HARDSTART KIT—POW-R-PAK WITH CAPACITOR

FOR ADDITIONAL INFORMATION, VISIT THE SUPCO WEBSITE AT www.supco.com

SUPCO HVAC ACCESSORIES



ID ORDER#	MODEL#	DESCRIPTION
716053	SUHS24	HUMIDIFIER—UNIVERSAL , 24V solenoid valve
713627	SSN24	IGNITER KIT—SILICON NITRIDE , 24V
713798	SHP350250	PRESSURE SWITCH , SPST
685498	NS2000031	PRESSURE SWITCH—UNIVERSAL , =Robertshaw #2374-510
205626	RW516	RATCHET WRENCH—REVERSIBLE , 1/4" to 3/16" square x 3/8" to 5/16" hex
205625	RW916	Same as above, but 1/4" to 3/16" square x 1/2" to 9/16" hex
710954	RCO410	RELAY CAPACITOR OVERLOAD
731962	MO44	RUST BUSTER SOLVENT , 4 ounces
713799	EM30	TACHOMETER , 100-30,000 rpm range, min/max, data hold, backlit LCD, auto power off and hard carrying case
713800	L180-20	THERMOSTAT , 60T11 single pole-single throw style 610073
713790	SXT114	TRANSFORMER—FOOT MOUNT , 20VA, 120/208/240
713171	SXT115	Same as above, but 40VA
5244	M098	ZOOM SPOUT OILER , with 14" telescopic spout for hard-to-reach places (=Millrose #70704)



FOR ADDITIONAL INFORMATION, VISIT THE SUPCO WEBSITE AT www.supco.com

SUPCO APPLIANCE ACCESSORIES



ID ORDER#	MODEL#	DESCRIPTION
710951	LP338	AGITATOR DOG—4 PIECE , =Whirlpool #285770
713312	DE1067	BEARING GLIDE , =G.E. #WE1M507, #WE1M316, #WE1M481 and #WE1M1067
710952	LP785	CLUTCH KIT , =Whirlpool #285785
731000	SM5411	CONDENSER FAN MOTOR , 9W, 120V, CW
713663	SM10170	CONDENSER FAN MOTOR , =G.E. #WR60X10170
710959	SH323	DEFROST HEATER , =Whirlpool #XR51X10055
712953	SH324	Same as above, but =G.E. #WR51X10053
710961	SH325	Same as above, but =G.E. WR51X10101
713659	SPN1111AD	DEFROST TIMER , 6-hour, 21-minute, =Whirlpool #4391974, Admiral #66128-1, Malory #34886, Paragon #A769-00 and #E1111-00, Uniline #3002-901 and Gemline #CC901 and #CC922
170920	S814500	DEFROST TIMER , used to control defrost cycles in walk-in freezers, 115V (=Paragon #8145-00)
170921	S814520	Same as above, but 208-240V (=Paragon #8145-20)
714683	DE16782E	DRUM ROLLER , =Samsung #DC97-07523B, =Supco #DE7523
713486	LB276	DRYER BELT , =Whirlpool #532910, #341241, #345473, Admiral #53-2910 and Maytag #31001026
711795	DE838	DRYER ELEMENT , =G.E. #WE11X10004, =Whirlpool #279838
725052	DE4771	Same as above, but =Whirlpool #8544771
713650	DE7747	Same as above, but =Whirlpool #3387747
713311	DE504	DRYER GLIDE—WHITE , =G.E. #WE1M504
710955	SDE358	DRYER IGNITER—SPIRAL , 120V, =GEM #DE358, G.E. #WE4X739 and #WE04X1032 and Frigidaire #134192000
714682	SDE364	DRYER IGNITER—UNIVERSAL FLAT , =Whirlpool #4391996, GLO BAR #304970, G.E. #WE4X750 and Frigidaire #5303937186



FOR ADDITIONAL INFORMATION, VISIT THE SUPCO WEBSITE AT www.supco.com

SUPCO APPLIANCE ACCESSORIES





ID ORDER#	MODEL#	DESCRIPTION
740454	DESAMKIT	DRYER REPAIR KIT , for Samsung driers
712934	SM999	EVAPORATOR FAN MOTOR KIT—UNIVERSAL , =GEM 240 Series
710943	DE382WR	GAS VALVE COIL KIT , for 25M Series (=Electrolux #5303931775; =Whirlpool #279834; =G.E. #WE4X10004, #WE4X10020, #WE4X10031 and #WE4X10048)
710932	ADC9102	ICEMAKER CONTROL BOARD , =Whirlpool #4389102R
713651	IMM8366	ICEMAKER MODULE HEAD , =Whirlpool #628366 and #628519
716026	RIM900	ICEMAKER REPLACEMENT KIT—UNIVERSAL , replaces most Whirlpool
713661	RIM2000	Same as above, but =Maytag #1165801A, Whirlpool #8340 and #AMKIT97
725854	RIM300	ICEMAKER REPLACEMENT KIT , for G.E. and Hotpoint IM1 through IM3 Series
713662	RIM597	Same as above, but =Whirlpool #2198597, #2198678 and #626663
713717	RIM943	Same as above, but =Whirlpool #4317943, #4210317, #625601 and #797991
710945	ES247	LID SWITCH , =Whirlpool #3949247
712932	ES671	Same as above, but =Whirlpool #3355808, #3352634, #3352632, #3352631, #3352360, #3352629 and #285671
713656	ES682	Same as above, but =Maytag #22001682
712933	ES8084	Same as above, but =Whirlpool #8318084
714558	ES9238	Same as above, but =Whirlpool #3949238
713658	ES18805	Same as above, but =GEM #18805 and #188-5
710953	L15525W	LIMIT THERMOSTAT WITH HEATER , SPST
713657	DE1002E	LINT SCREEN , =LG #5231EL1003A, #5231EL10038 and #5231EL1002E
713152	LP753	MOTOR COUPLER , =Whirlpool #285753A
732377	SGR5066	OVEN IGNITER—FLAT , =Frigidaire #5303935066, Whirlpool #12400035 and #814269, G.E. #WB2X9998 and WB13K21, and Supco #SGR412
713313	SGR403	OVEN IGNITER—ROUND , =GEM #GR403, G.E. #WB2X9154, Electrolux #5304401265, Maytag #309155 and Whirlpool #3196447



FOR ADDITIONAL INFORMATION, VISIT THE SUPCO WEBSITE AT www.supco.com

SUPCO APPLIANCE ACCESSORIES



ID ORDER#	MODEL#	DESCRIPTION
711148	OLK1786	RELAY KIT , =Whirlpool #8201786
713317	OLK7913	Same as above, but =Whirlpool #4387913, #819099, #4387836 and #4357207
710944	ES1024STL	SAIL SWITCH WITH METAL PLUNGER , =OEM #JMPO-102-4C, #03336A-000, #251010, #535152, #PRS486754, #DRS32346A and #ES1024C
776374	S903758	SILICONE CARBIDE IGNITER—FLAT , =Nortek #903758 (Starlite)
 710956	SET184	THERMAL CUTOFF KIT , =Whirlpool #279769
713207	SET194	Same as above, but =Whirlpool #279816
713206	SET197	Same as above, but =Whirlpool #3977767
710957	SET401	THERMAL FUSE , =Whirlpool #3392519 and #33886651 and G.E. #WE4X857
710958	SET402	Same as above, but =Whirlpool #3390719 and #690198
713649	SET405	Same as above, but =Maytag #LA1053
713314	LP2001T	WASHER DRAIN PUMP , =LG #4681EA2001T
713652	LP30913	Same as above, but =Whirlpool #W10730972 and #W101390913
713653	LP36347	Same as above, but =Whirlpool #W10536347
713654	LP280187	Same as above, but =Whirlpool #280187
 710949	LP115	WASHER PUMP , =Whirlpool #383957, #370403, #369617, #367103, #367068, #358258, #357729 and #285317
711147	LP116	Same as above, =Whirlpool #3348015, #3363394, #3348014, #3348215 and #3352492
713655	LP123	Same as above, but =Maytag #21001732, Whirlpool #21001732, #21001906 and #35-6465
710950	LP128	Same as above, but =Maytag #35-6465, #211001906, #21001723, #21002219, #21001873 and #21002240
713664	WV5154	WATER VALVE , =Whirlpool #67005154, #8208275, #2068910, #8208153, #67003818 and #1071263

FOR ADDITIONAL INFORMATION, VISIT THE SUPCO WEBSITE AT www.supco.com

RINNAI

DIRECT VENT WALL FURNACES



- EnergySaver modulating technology
- Direct, through-wall vent termination
- Flexible configurations
- Works with wifi-compatible thermostats (thermostat not included)
- Dual timer settings
- 7-stage modulating gas valve
- Negative coefficient thermistor detects temperature change in 1/2 of a degree
- Variable speed inducer motor with pressure switch
- 1/2" NPT gas connection
- Electronic spark ignition
- Stainless steel Bunsen burners
- Continuously monitoring self-diagnostic electronics
- Wall thermostat connectable
- Natural gas or propane models available



**REGISTERED
RESIDENTIAL WARRANTY**

- 10 year heat exchanger
- 5 year parts
- 2 year labor

ID ORDER#	MODEL#	FUEL	AFUE	ELECTRICAL CONNECTION	BTUH INPUT MIN-MAX	BTUH OUTPUT MIN-MAX	GAS SUPPLY PRESSURE MIN-MAX W.C.	DIMENSIONS W x D x H
746338	EX22CTWN	NG	81%	120V-60Hz-56W	8,200-21,500	6,560-17,200	3.5"-10.5"	29.9" x 10.1" x 22.9"
762730 *	EX22CTWP	LP	81%	120V-60Hz-56W	8,200-20,700	6,560-16,560	8.0"-13.0"	29.9" x 10.1" x 22.9"
747079	EX38CTWN	NG	80%	120V-60Hz-117W	13,200-38,400	10,560-30,720	3.5"-10.5"	36.63" x 13" x 26.4"
741084	EX38CTWP	LP	80%	120V-60Hz-117W	13,200-36,500	10,560-29,200	8.0"-13.0"	36.63" x 13" x 26.4"

ACCESSORIES

762735	204000040	NG-LP CONVERSION KIT , for EX22CTW and EX22CT
762737	204000045	WALL THERMOSTAT INSTALLATION KIT—LESS THERMOSTAT

* = SPECIAL ORDER ITEM

**FOR ADDITIONAL INFORMATION, VISIT THE
RINNAI WEBSITE AT www.rinnai.us**

EMPIRE WALL FURNACES

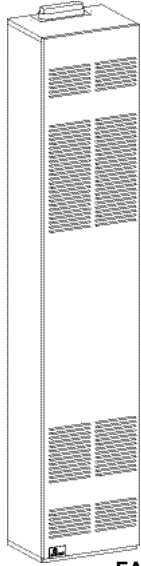

FAW-40-IPX

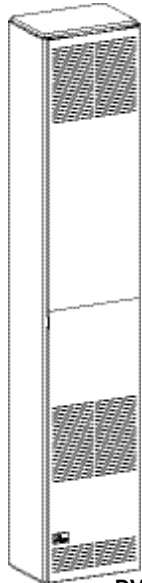

DVC-55-SPPX

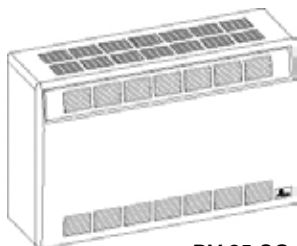

DV-25-SG

ID ORDER#	MODEL#	FUEL	INPUT	DIMENSIONS (W x D x H)
--------------	--------	------	-------	---------------------------

COUNTERFLOW WALL FURNACES

(Standing pilot less thermostat)

* = SPECIAL ORDER ITEM

127572	FAW-40-SPPX	NG	40,000	14-1/8" x 10-3/8" x 72-1/2"
158853	FAW-40-SPPX	LP	40,000	14-1/8" x 10-3/8" x 72-1/2"
32371	FAW-55-SPPX	NG	55,000	16" x 11-5/16" x 82-3/8"
32372	FAW-55-SPPX	LG	55,000	16" x 11-5/16" x 82-3/8"

COUNTERFLOW WALL FURNACES

(Electronic ignition less thermostat)

158848	FAW-40-IPX	NG	40,000	14-1/8" x 10-3/8" x 72-1/2"
158849	FAW-40-IPX	LP	40,000	14-1/8" x 10-3/8" x 72-1/2"
158812	FAW-55-IPX	NG	55,000	16" x 11-5/16" x 82-3/8"
157672	FAW-55-IPX	LP	55,000	16" x 11-5/16" x 82-3/8"

DIRECT VENT COUNTERFLOW WALL FURNACES

(Standing pilot less thermostat)

19913	DVC-35-SPPX	NG	35,000	14-1/8" x 10-3/8" x 72-1/2"
192438	DVC-35-SPPX	LP	35,000	14-1/8" x 10-3/8" x 72-1/2"
41682	DVC-55-SPPX	NG	55,000	16" x 11-5/16" x 82-3/8"
41443	DVC-55-SPPX	LP	55,000	16" x 11-5/16" x 82-3/8"

DIRECT VENT WALL FURNACES

(Standing pilot with thermostat)

51863	DV-25-SG	NG	25,000	37" x 11-1/2" x 28"
143944	DV-25-SG	LP	25,000	37" x 11-1/2" x 28"
51341	DV-35-SG	NG	35,000	37" x 11-1/2" x 28"
52026	DV-35-SG	LP	35,000	37" x 11-1/2" x 28"

DIRECT VENT WALL FURNACES

(Standing pilot less thermostat)

33011	DV-210-SGX	NG	10,000	16-1/4" x 9-3/8" x 21-3/8"
65449	DV-210-SGX	LP	10,000	16-1/4" x 9-3/8" x 21-3/8"
295	DV-215-SGX	NG	15,000	20-1/4" x 9-3/8" x 24-7/8"
296	DV-215-SGX	LP	15,000	20-1/4" x 9-3/8" x 24-7/8"

**FOR ADDITIONAL INFORMATION, VISIT THE
EMPIRE WEBSITE AT www.empirezoneheat.com**

WARRANTY: 10 year limited warranty on combustion chamber, 1 year limited warranty on parts

EMPIRE ROOM HEATERS



ID ORDER#	MODEL#	FUEL	INPUT	DIMENSIONS (W x D x H)
--------------	--------	------	-------	---------------------------

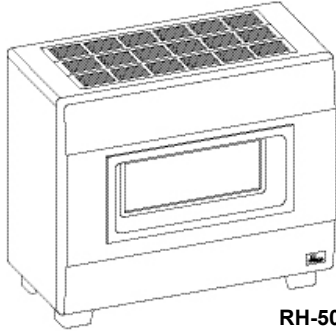

RH-50C

VISUAL FLAME ROOM HEATERS WITH BLOWER

(Standing pilot with built-in hydraulic thermostat) (†)

47989	RH-50B	NG	50,000	34" x 23-3/16" x 29-9/16"
56023	RH-50B	LP	50,000	34" x 23-3/16" x 29-9/16"
47990	RH-65B	NG	65,000	34" x 27-11/16" x 29-9/16"
58138	RH-65B	LP	65,000	34" x 27-11/16" x 29-9/16"

CLOSED FRONT ROOM HEATERS LESS BLOWER

(Standing pilot with built-in hydraulic thermostat) (†)

396592	RH-50C	NG	50,000	34" x 23-3/16" x 29-9/16"
377851	RH-50C	LP	50,000	34" x 23-3/16" x 29-9/16"
338406	RH-65C	NG	65,000	34" x 27-11/16" x 29-9/16"
352260	RH-65C	LP	65,000	34" x 27-11/16" x 29-9/16"

**FOR ADDITIONAL INFORMATION, VISIT THE
EMPIRE WEBSITE AT www.empirezoneheat.com**

WARRANTY: 10 year limited warranty on combustion chamber, 5 year limited warranty on all other components except remote control and thermostats, 1 year warranty on remote control, 2 year limited labor warranty on all components except remote control and thermostats

(†) Depth of room heater includes draft diverter

SEPTEMBER 2024

Line #4900

EMPIRE WALL FURNACE ACCESSORIES

516.2



ID ORDER#	MODEL#	DESCRIPTION	FOR MODEL
236154	FRB-3	BLOWER , automatic	RH-50C/65C
51344	DRB-1	BLOWER KIT , with cord and plug, 75 cfm	DV-25/35; RH-25/35
307	DVB-1	Same as above, but 60 cfm	DV-210/215
158541	RH-425	FLOOR PAD , 36 x 21	DV-25/35, RH-50B/C/CB, RH-65B/C/CB
615367	RHL-2	LOG SET	RH-50B/65B
303 *	SOK-1	OUTLET KIT—SIDE , 10" maximum extension, fixed register	FAW-40/55 DV-55/DVC-55
127082	ROK-1	OUTLET KIT—REAR , 10" maximum extension, 12 x 8 adjustable register	FAW-40/55
27116 *	RAD-8	RADIANTS AND SUPPORTS	RH-50/65B
153968	SOR-1	REGISTER—SIDE , fixed register	FAW-40/55 DV-55/DVC-35
305	DV-651	VENT ENCLOSURE , 14"	FAW-55
306	DV-665	Same as above, but 24"	FAW-55
245767 *	DV-666	Same as above, but 36"	FAW-55
213893	FVE24DB	VENT ENCLOSURE , 24"	FAW-40
213905	FVE34	Same as above, but 34"	FAW-40
190608 *	FVE46	Same as above, but 46"	FAW-40
94244	DV-822	VINYL SIDING VENT KIT (Note: Adds 3" to wall depth)	DV Series

* = SPECIAL ORDER ITEM

**FOR ADDITIONAL INFORMATION, VISIT THE
EMPIRE WEBSITE AT www.empirezoneheat.com**

WHITE MOUNTAIN HEARTH FIREPLACE INSERTS



- Millivolt standing pilot with Piezo igniter (no electric or battery backup required)
- Single hole vent-within-a-vent
- Heater rated with a maximum Steady State Efficiency up to 82%
- Top and bottom louvers
- Controls concealed behind lower panel
- Hem-bent seams provide better seal and eliminate screws and fasteners
- Glowing embers and lava rock included
- Aged brick, herringbone, stacked limestone and black reflective liner options



WARRANTY

- Lifetime limited warranty on combustion chamber, heat exchanger and factory-installed glass
- 3 year limited warranty on all other components
- 1 year limited warranty on remote control, thermostat, accessories and parts

ID ORDER#	MODEL#	FUEL	INPUT BTU	LOG SET	VENTING SIZE	DIMENSIONS (W x D x H)
-----------	--------	------	-----------	---------	--------------	------------------------

TAHOE DELUXE DIRECT VENT FIREPLACE (†)

646639	DVD36FP31N	NG	20,000	5-piece	4" x 6-5/8"	37" x 16-3/8" x 32-3/4"
714932	DVD42FP31N	NG	25,000	7-piece	4" x 6-5/8"	43" x 16-3/8" x 34-3/4"

(†) Note: requires a fireplace barrier screen or a door set and frames with barrier screen.

TAHOE PREMIUM DIRECT VENT FIREPLACE

693926	DVP36FP31N	NG	25,000	4-piece	4" x 6-5/8"	39" x 19-7/8" x 37-5/8"
--------	------------	----	--------	---------	-------------	-------------------------

FOR ACCESSORIES, SEE PAGE 516.4

FOR ADDITIONAL INFORMATION, VISIT www.whitemountainhearth.com (a division of Empire)

SEPTEMBER 2024

Line #4900

WHITE MOUNTAIN HEARTH ACCESSORIES





516.4



ID ORDER#	MODEL#	DESCRIPTION
699520	DVFB36SBL	BARRIER SCREEN , 36" short, black matte, for DVD36FP31N
710673	DVFB36TBL	Same as above, but 36" tall and for DVP36FP31N
695637	DVFB42TBL	Same as above, but 42" tall and for DVD42FP31N
621566	SD46DVAE90	ELBOW—90°—GALVANIZED
713032	SD46DVA16A	EXTENSION—ADJUSTABLE , 3" to 15"
446019	FBB-4	FIREPLACE BLOWER , variable speed, temperature switch
613186	SD46DVAVCH	HIGH WIND CAP—VERTICAL
619457	18442	NG-LP CONVERSION KIT , for DVD36FP3 (0, 1, 2, 3) -1 and DVCD36FP3 (1, 2, 3) -1
705476	23441	Same as above, but for DVP36FP3 (1, 2, 3) -3 and DVP36DP31-3
739532	18814	Same as above, but for DVD42FP3 (0, 1, 2, 3) -1
234462	FRBC	REMOTE CONTROL , millivolt battery, on/off
619580	DVVK4TP	VENT KIT—TOP VENT (HORIZONTAL) , for 8-12" wall thickness
623344	SD46DVA24	VENT PIPE—GALVANIZED , 24"
613187	SD46DVA48	Same as above, but 48"
649227	DVVK4REVS	VINYL SIDING HORIZONTAL VENT KIT
649392	SD46DVAVSS	VINYL SIDING STANDOFF

FOR ADDITIONAL INFORMATION, VISIT www.whitemountainhearth.com (a division of Empire)

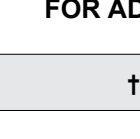

ID ORDER#	MODEL#	SIZE	DESCRIPTION	CTN QTY
ROUND CEILING DIFFUSERS				
NOTE: CFM ratings listed are based on 500 FPM. Free area = Ak x 144.				
	16 (W)		ROUND CEILING DIFFUSER, STEP-DOWN WITH GASKET , all-steel construction with dover white enamel finish	
733		6"	Same as above, 19 square inches free area, 65 cfm	20
735		8"	Same as above, 32 square inches free area, 115 cfm	20
736		10"	Same as above, 50 square inches free area, 175 cfm	10
	11 (GS)		STEEL-MOUNTING RING FOR #16 DIFFUSER , golden sand finish, must be included when not using a damper	
690		6"	Same as above	10
698		8"	Same as above	10
702		10"	Same as above	10
	12 (GS)		MOUNTING RING AND BUTTERFLY DAMPER FOR #16 DIFFUSER , golden sand finish, complete with removable damper knob	
718		6"	Same as above	20
721		8"	Same as above	20
726		10"	Same as above	10
SQUARE CEILING DIFFUSERS				
	A504OB (W)		SQUARE CEILING DIFFUSER, SURFACE MOUNT WITH GASKET , all-aluminum construction, with OB damper; dover white enamel finish	
48634		6" x 6"	Same as above, 19 square inches free area, 65 cfm	10
48635		8" x 8"	Same as above, 29 square inches free area, 90 cfm	10
48636		10" x 10"	Same as above, 42 square inches free area, 135 cfm	5
48183		12" x 12"	Same as above, 60 square inches free area, 210 cfm	5
48639		14" x 14"	Same as above, 85 square inches free area, 305 cfm	5
T-BAR DIFFUSERS — LESS COLLAR				
	HVS † (W)	24" x 24"	"T" BAR DROP-IN SUPPLY DIFFUSER , high air volume with flush design, heavy-gauge steel-face, molded fiberglass back, white enamel finish, less collar and damper	2
1237	HVS-14 † (W)	24" x 24"	Same as above, but the 14" snap-in collar ring comes attached as standard, white enamel finish	2
	PDS † (W)	24" x 24"	"T" BAR PERFORATED DIFFUSER SUPPLY/RETURN GRILLE , steel construction with molded fiberglass back, for 6-12" collar, less collar and damper, white enamel finish	4
9181				
	RENP † (W)	20" x 20"	"T" BAR PERFORATED RETURN , perforated steel with R4.2 molded fiberglass back panel, bright white finish, 23-3/4" x 23-3/4" overall size	4
467551				





FOR ADDITIONAL INFORMATION, VISIT THE HART & COOLEY WEBSITE AT www.hartandcooley.com

† All HVS, PDS and RENP diffusers require the #5400 snap-in collar ring. The #3800 damper is optional.

HART & COOLEY

T-BAR DIFFUSERS & ACCESSORIES







ID ORDER#	MODEL#	SIZE	DESCRIPTION	CTN QTY
T-BAR DIFFUSERS — WITH COLLAR			NOTE: CFM ratings listed are based on 500 FPM. Free area = Ak x 144.	
	FPD3 SERIES (W)		"T" BAR DROP-IN SUPPLY DIFFUSER WITH 2" HIGH FIXED COLLAR , 360° pattern for high volume delivery, less damper, 24" x 24", 3-cone fixed core, 1-1/4" projection from ceiling, steel construction, white enamel finish, optional #3800 butterfly damper is adjustable through face	
512359	FPD306	24" x 24" - 6"	Same as above	2
512360	FPD308	24" x 24" - 8"	Same as above	2
512361	FPD310	24" x 24" - 10"	Same as above	2
512362	FPD312	24" x 24" - 12"	Same as above	2
512363	FPD314	24" x 24" - 14"	Same as above	2
T-BAR DIFFUSER ACCESSORIES				
	5400 SERIES		SNAP-IN COLLAR RING WITH SHORT PUSH PINS	
1200	5406	6"	Same as above	12
1202	5408	8"	Same as above	12
1205	5410	10"	Same as above	10
1207	5412	12"	Same as above	10
141070	5414	14"	Same as above	4
	6400 SERIES		TAB-STYLE COLLAR RING , for fiberglass-backed diffusers, tab-style (push pins not required)	
569336	6406	6"	Same as above	1
569342	6408	8"	Same as above	1
569343	6410	10"	Same as above	1
569344	6412	12"	Same as above	1
569345	6414	14"	Same as above	1
	3800 SERIES		ROUND BUTTERFLY DAMPER , with removable handle, for use with #5400 and #6400 collar	
1187	3806	6"	Same as above	12
1189	3808	8"	Same as above	12
1192	3810	10"	Same as above	10
1194	3812	12"	Same as above	10
1197	3814	14"	Same as above	8

FOR ADDITIONAL INFORMATION, VISIT THE HART & COOLEY WEBSITE AT www.hartandcooley.com

HART & COOLEY

TOE-SPACE GRILLES & SIDEWALL REGISTERS



ID ORDER#	MODEL#	SIZE	DESCRIPTION	CTN QTY
TOE-SPACE GRILLES				
NOTE: CFM ratings listed are based on 500 FPM. Free area = Ak x 144.				
	420 (W)		TOE-SPACE GRILLE , dover white enamel finish, steel, less damper	
579183		10" x 2"	Same as above, 12 square inches free area, 45 cfm	15
987		12" x 2"	Same as above, 14 square inches free area, 50 cfm	15
989		12" x 4"	Same as above, 28 square inches free area, 100 cfm	10
	420 (GS)		TOE-SPACE GRILLE , golden sand finish, steel, less damper	
584770		10" x 2"	Same as above, 12 square inches free area, 45 cfm	15
37570		12" x 2"	Same as above, 14 square inches free area, 50 cfm	15
SIDEWALL REGISTERS				
	651 (W)		SIDEWALL REGISTER , with single-hinged damper, adjustable handle, gasketed, dover white enamel finish	
1112		10" x 4"	Same as above, 16 square inches free area, 67 cfm	1
1114		10" x 6"	Same as above, 33 square inches free area, 115 cfm	20
	661 (W)		SIDEWALL REGISTER , featuring double deflection, dover white enamel finish, steel construction	
50270		10" x 4"	Same as above, 21 square inches free area, 75 cfm	20
1173		10" x 6"	Same as above, 35 square inches free area, 125 cfm	20
684655		10" x 8"	Same as above, 50 square inches free area, 175 cfm	10
1174		12" x 6"	Same as above, 42 square inches free area, 150 cfm	20
665538		12" x 8"	Same as above, 61 square inches free area, 215 cfm	10
1175		14" x 6"	Same as above, 52 square inches free area, 180 cfm	20
1177		14" x 8"	Same as above, 74 square inches free area, 260 cfm	10
	821 (W)		SIDEWALL REGISTER , single deflection with adjustable vertical face bars, horizontal louvers, all-steel construction, multi-shutter valve, removable handle, gasketed and stocked in dover white enamel finish (NOTE: CFM ratings are based on 500 FPM and free area is calculated using Deflection "E" specifications.)	
134427		10" x 4"	Same as above, 23 square inches free area, 80 cfm	10
237817		12" x 4"	Same as above, 27 square inches free area, 95 cfm	10
22063		10" x 6"	Same as above, 35 square inches free area, 120 cfm	10
22064		12" x 6"	Same as above, 42 square inches free area, 145 cfm	10
1265		12" x 8"	Same as above, 57 square inches free area, 200 cfm	10
1268		14" x 8"	Same as above, 64 square inches free area, 220 cfm	10
1270		16" x 8"	Same as above, 71 square inches free area, 250 cfm	5
1272		20" x 8"	Same as above, 97 square inches free area, 335 cfm	5

FOR ADDITIONAL INFORMATION, VISIT THE HART & COOLEY WEBSITE AT www.hartandcooley.com

HART & COOLEY BASEBOARD & FLOOR DIFFUSERS & REGISTERS





ID ORDER#	MODEL#	SIZE	DESCRIPTION	CTN QTY
BASEBOARD DIFFUSERS AND REGISTERS				
NOTE: CFM ratings listed are based on <u>500 FPM</u> . Free area = Ak x 144.				
970	406 (W)	18"	BASEBOARD DIFFUSER , all-steel with damper, dover white enamel finish, with 37 square inches free area, 130 cfm	12
1007	462 (W)	2 ft.	BASEBOARD DIFFUSER , all-steel with damper, dover white enamel finish, with 27 square inches free area, 95 cfm; use 2-1/4" boot	12
1008	464 (W)	4 ft.	Same as above, but rated at 54 square inches free area, 185 cfm	4
1119	654 (W)	10" x 6"	BASEBOARD REGISTER , all-steel construction, dover white enamel finish, 3/4" projection, damper, double deflection, volume damper	20
1121		12" x 6"	Same as above, 33 square inches free area, 115 cfm	20
1123		14" x 6"	Same as above, 42 square inches free area, 145 cfm	10
	664 (W)		BASEBOARD REGISTER , all-steel construction, bright white enamel finish, multi-shutter damper, 1/3"-spaced fins set at 20 degrees, 7/8" margin turnback, 1-5/8" depth when fully opened	
635425		12" x 6"	Same as above, 49 square inches free area, 170 cfm	20
FLOOR REGISTERS AND DIFFUSERS				
830	210 (GS)	6" x 10"	FLOOR REGISTER , all-steel with golden sand finish, rigid construction with toe-operated damper control, free area averages over 75 percent	10
834		6" x 12"	Same as above, 46 square inches free area, 160 cfm	10
837		6" x 14"	Same as above, 55 square inches free area, 190 cfm	10
840		8" x 12"	Same as above, 63 square inches free area, 220 cfm	10
846		10" x 12"	Same as above, 76 square inches free area, 265 cfm	5
11946		12" x 14"	Same as above, 94 square inches free area, 325 cfm	5
972	411 (GS)	4" x 10"	FLOOR DIFFUSER , all-steel welded construction with golden sand finish, volume control screw and positive lock provision	10
974		4" x 12"	Same as above, 25 square inches free area, 85 cfm	10
976		4" x 14"	Same as above, 30 square inches free area, 105 cfm	10
977		6" x 12"	Same as above, 36 square inches free area, 125 cfm	10
980		6" x 14"	Same as above, 48 square inches free area, 165 cfm	10

FOR ADDITIONAL INFORMATION, VISIT THE HART & COOLEY WEBSITE AT www.hartandcooley.com

HART & COOLEY

FLOOR DIFFUSERS & SIDEWALL OR CEILING REGISTERS



ID ORDER#	MODEL#	SIZE	DESCRIPTION	CTN QTY
FLOOR DIFFUSERS			NOTE: CFM ratings listed are based on <u>500 FPM</u> . Free area = Ak x 144.	
421 (GS)			FLOOR DIFFUSER, GOLDEN SAND , stamped steel construction with golden sand finish, volume control screw and positive lock provision	
	993	2" x 10"	Same as above, 12 square inches free area, 45 cfm	30
	996	2" x 12"	Same as above, 14 square inches free area, 50 cfm	30
	999	2" x 14"	Same as above, 17 square inches free area, 60 cfm	30
	175368	4" x 8"	Same as above, 19 square inches free area, 65 cfm	20
	1001	4" x 10"	Same as above, 24 square inches free area, 85 cfm	20
	1003	4" x 12"	Same as above, 28 square inches free area, 100 cfm	20
	1004	4" x 14"	Same as above, 33 square inches free area, 115 cfm	20
421 (W)			FLOOR DIFFUSER, DOVER WHITE , stamped steel construction with white finish, volume control screw and positive lock provision	
	56812	2" x 12"	Same as above, 14 square inches free area, 50 cfm	30
	60432	2" x 14"	Same as above, 17 square inches free area, 60 cfm	30
	53181	4" x 10"	Same as above, 24 square inches free area, 85 cfm	20
	56810	4" x 12"	Same as above, 28 square inches free area, 100 cfm	20
	178428	4" x 14"	Same as above, 33 square inches free area, 115 cfm	20
	1018	4" x 14"	ALUMINUM FLOOR DIFFUSER , with dual air valve and nylon valve operators, clear anodized finish; heating: 24 square inches free area, 80 cfm; cooling: 26 square inches free area, 90 cfm	10
SIDEWALL OR CEILING REGISTER				
	15736	301 (W)	10" x 6" SIDEWALL OR CEILING REGISTER , one-way deflection, steel one-piece stamped face curved blade construction, dover white enamel finish, 20 square inches free area, 70 cfm	20

FOR ADDITIONAL INFORMATION, VISIT THE HART & COOLEY WEBSITE AT www.hartandcooley.com

HART & COOLEY

SIDEWALL OR CEILING RETURN AIR GRILLES





ID ORDER#	MODEL#	SIZE	DESCRIPTION	CTN QTY
SIDEWALL OR CEILING RETURN AIR GRILLES				
NOTE: CFM ratings listed are based on 400 FPM. Free area = Ak x 144.				
650 (W)				
				
			SIDEWALL OR CEILING RETURN AIR GRILLE , steel one-piece construction in dover white enamel finish. <u>Horizontal dimension is listed first</u> , overall dimension is listed size plus 1-3/4" (The CFM for 650 W grilles is based on 400 FPM not 500 FPM.)	
36271		8" x 8"	Same as above, 43 square inches free area, 120 cfm	10
248895		10" x 4"	Same as above, 27 square inches free area, 74 cfm	10
67843		10" x 6"	Same as above, 40 square inches free area, 112 cfm	10
664265		10" x 8"	Same as above, 54 square inches free area, 150 cfm	10
133955		10" x 10"	Same as above, 68 square inches free area, 188 cfm	10
1034		12" x 4"	Same as above, 32 square inches free area, 88 cfm	10
1035		12" x 6"	Same as above, 49 square inches free area, 135 cfm	10
1038		12" x 8"	Same as above, 65 square inches free area, 180 cfm	10
1040		12" x 12"	Same as above, 98 square inches free area, 272 cfm	10
1042		14" x 4"	Same as above, 38 square inches free area, 105 cfm	10
1048		14" x 6"	Same as above, 57 square inches free area, 158 cfm	10
1049		14" x 8"	Same as above, 76 square inches free area, 211 cfm	10
1050		14" x 10"	Same as above, 95 square inches free area, 265 cfm	10
1052		14" x 12"	Same as above, 115 square inches free area, 318 cfm	10
1053		14" x 14"	Same as above, 134 square inches free area, 372 cfm	5
1057		16" x 8"	Same as above, 87 square inches free area, 242 cfm	10
1058		16" x 14"	Same as above, 153 square inches free area, 426 cfm	5
1059		16" x 16"	Same as above, 176 square inches free area, 488 cfm	5
1067		18" x 18"	Same as above, 223 square inches free area, 619 cfm	5
1072		20" x 8"	Same as above, 108 square inches free area, 300 cfm	10
1074		20" x 10"	Same as above, 137 square inches free area, 380 cfm	10
1075		20" x 12"	Same as above, 164 square inches free area, 457 cfm	10
1076		20" x 14"	Same as above, 192 square inches free area, 534 cfm	5
1078		20" x 20"	Same as above, 276 square inches free area, 767 cfm	5
1080		24" x 6"	Same as above, 98 square inches free area, 272 cfm	10
1082		24" x 8"	Same as above, 131 square inches free area, 364 cfm	10
1090		24" x 10"	Same as above, 164 square inches free area, 457 cfm	10
1091		24" x 12"	Same as above, 198 square inches free area, 550 cfm	10
1092		24" x 14"	Same as above, 231 square inches free area, 643 cfm	5
1094		24" x 20"	Same as above, 332 square inches free area, 923 cfm	5
1095		24" x 24"	Same as above, 400 square inches free area, 1110 cfm	5
1098		30" x 6"	Same as above, 123 square inches free area, 341 cfm	10
1100		30" x 8"	Same as above, 164 square inches free area, 457 cfm	10
1103		30" x 10"	Same as above, 206 square inches free area, 573 cfm	10
1105		30" x 12"	Same as above, 248 square inches free area, 689 cfm	5
1109		30" x 24"	Same as above, 397 square inches free area, 1392 cfm	5

FOR ADDITIONAL INFORMATION, VISIT THE HART & COOLEY WEBSITE AT www.hartandcooley.com

HART & COOLEY

SIDEWALL OR CEILING GRILLES BASEBOARD RETURN AIR INTAKES





ID ORDER#	MODEL#	SIZE	DESCRIPTION	CTN QTY	
SIDEWALL OR CEILING GRILLES			NOTE: CFM ratings listed are based on 400 FPM. Free area = Ak x 144.		
	659 (W)	--	FILTER GRILLE for sidewall or ceiling use. <u>Horizontal dimension is listed first</u> ; one-piece steel in bright white enamel finish; filter not included		
	1166	14" x 20"	Same as above, 192 square inches free area, 534 cfm	3	
	66742	14" x 24"	Same as above, 231 square inches free area, 643 cfm	5	
	216799	14" x 25"	Same as above, 248 square inches free area, 690 cfm	3	
	1169	16" x 20"	Same as above, 218 square inches free area, 606 cfm	3	
	1170	16" x 25"	Same as above, 265 square inches free area, 735 cfm	3	
	568637	20" x 14"	Same as above, 192 square inches free area, 534 cfm	3	
	1158	20" x 16"	Same as above, 210 square inches free area, 580 cfm	3	
	1161	20" x 20"	Same as above, 276 square inches free area, 767 cfm	3	
	1172	20" x 25"	Same as above, 346 square inches free area, 962 cfm	3	
	1165	25" x 16"	Same as above, 266 square inches free area, 748 cfm	3	
	1250	REF5-T (W)	FILTER GRILLE for flush, 2' x 2' "T" bar mounting, all aluminum with bright white enamel finish, features 1/2" egg crate grid, 20" x 20" x 1" filter required but not furnished, grille hinged to frame, 288 square inches free area, 800 cfm	1	
	1245	RE5-T (W)	Same as above except grille only, 348 square inches free area, 970 cfm	5	
	40003	RE5-TI (W)	Same as RE5-T, but with a molded fiberglass back to accommodate #6400 series collar, 348 square inches free area, 970 cfm	4	
	141901	5400PP	--	PUSH PIN FOR #RE5-TI , if #5400 series collar is used (attaches collar to grille)	100
		RE5 (W)	--	SIDEWALL OR CEILING RETURN AIR GRILLE , all aluminum frame with aluminum 1/2" egg crate grid, bright white enamel finish, surface mounted with flange	
	37461	12" x 8"	Same as above, 62 square inches free area, 180 cfm	1	
	1219	12" x 12"	Same as above, 89 square inches free area, 249 cfm	10	
	1224	18" x 12"	Same as above, 141 square inches free area, 392 cfm	1	
	1226	18" x 18"	Same as above, 219 square inches free area, 608 cfm	1	
BASEBOARD RETURN AIR INTAKES					
	971	407 (W)	18"	BASEBOARD RETURN AIR INTAKE , all-steel construction, bright white enamel finish, 37 square inches free area, 105 cfm	12

FOR ADDITIONAL INFORMATION, VISIT THE HART & COOLEY WEBSITE AT www.hartandcooley.com

HART & COOLEY BASEBOARD & FLOOR RETURN AIR GRILLES

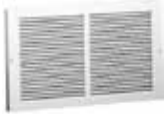

ID ORDER#	MODEL#	SIZE	DESCRIPTION	CTN QTY
BASEBOARD RETURN AIR GRILLES				
NOTE: CFM ratings listed are based on 500 FPM. Free area = Ak x 144.				
657 (W)				
			BASEBOARD RETURN AIR GRILLE with 7/8" projection, one-piece stamped steel construction in bright white enamel finish	
	1126	12" x 6"	<i>Same as above</i> , 66 square inches free area, 180 cfm	10
	1128	14" x 6"	<i>Same as above</i> , 76 square inches free area, 210 cfm	20
	1130	14" x 8"	<i>Same as above</i> , 104 square inches free area, 288 cfm	10
	1132	16" x 8"	<i>Same as above</i> , 120 square inches free area, 330 cfm	10
	1137	24" x 6"	<i>Same as above</i> , 132 square inches free area, 365 cfm	10
	1140	24" x 8"	<i>Same as above</i> , 174 square inches free area, 485 cfm	10
	1143	30" x 6"	<i>Same as above</i> , 161 square inches free area, 445 cfm	10
	1144	30" x 8"	<i>Same as above</i> , 216 square inches free area, 600 cfm	10
658 (W)				
			BASEBOARD RETURN AIR GRILLE , with 3-3/4" projection, one-piece stamped steel construction in dover white enamel finish	
	1146	14" x 6"	<i>Same as above</i> , 76 square inches free area, 210 cfm	8
	1149	14" x 8"	<i>Same as above</i> , 104 square inches free area, 288 cfm	8
	1151	24" x 6"	<i>Same as above</i> , 132 square inches free area, 365 cfm	8
	1154	30" x 6"	<i>Same as above</i> , 161 square inches free area, 445 cfm	8
	1156	30" x 8"	<i>Same as above</i> , 216 square inches free area, 600 cfm	8
FLOOR RETURN-AIR GRILLES				
265 (GS)				
			FLOOR RETURN AIR GRILLE , all-steel, with golden sand finish, rigid construction and featuring over 75% free area	
	855	6" x 10"	<i>Same as above</i> , 53 square inches free area, 150 cfm	6
	857	6" x 12"	<i>Same as above</i> , 64 square inches free area, 180 cfm	6
	859	6" x 14"	<i>Same as above</i> , 73 square inches free area, 205 cfm	6
	863	6" x 24"	<i>Same as above</i> , 122 square inches free area, 340 cfm	6
	865	6" x 30"	<i>Same as above</i> , 148 square inches free area, 410 cfm	6
	960	8" x 14"	<i>Same as above</i> , 98 square inches free area, 270 cfm	6
	961	8" x 16"	<i>Same as above</i> , 103 square inches free area, 370 cfm	6
	684027	8" x 20"	<i>Same as above</i> , 136 square inches free area, 380 cfm	6
	962	8" x 24"	<i>Same as above</i> , 160 square inches free area, 445 cfm	6
	964	8" x 30"	<i>Same as above</i> , 194 square inches free area, 540 cfm	6
	965	10" x 12"	<i>Same as above</i> , 104 square inches free area, 290 cfm	6
	966	10" x 14"	<i>Same as above</i> , 118 square inches free area, 330 cfm	6
	570301	10" x 20"	<i>Same as above</i> , 160 square inches free area, 450 cfm	4
	967	10" x 24"	<i>Same as above</i> , 190 square inches free area, 540 cfm	4
	968	10" x 30"	<i>Same as above</i> , 242 square inches free area, 670 cfm	4
	649185	12" x 12"	<i>Same as above</i> , 122 square inches free area, 340 cfm	6
	969	14" x 14"	<i>Same as above</i> , 166 square inches free area, 460 cfm	6
	524775	14" x 30"	<i>Same as above</i> , 340 square inches free area, 940 cfm	4

FOR ADDITIONAL INFORMATION, VISIT THE HART & COOLEY WEBSITE AT www.hartandcooley.com

E-Z AIRE AIR-TO-AIR HEAT EXCHANGERS



- Air-to-air aluminum plate-type heat exchanger
- Recaptures up to 85% of heat energy in exhausted air
- Effective for humidity, odor, radon, formaldehyde and smoke control in homes, offices, halls and spa/pool areas
- Integral defrost system
- Low-voltage package reduces line voltage to 24 volts for controls

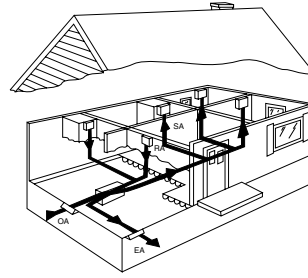

ID ORDER#	MODEL #	DESCRIPTION	* = SPECIAL ORDER ITEM
--------------	---------	-------------	------------------------

HEAT EXCHANGERS

63613 *	EZA-970	COMMERCIAL-SIZED HEAT EXCHANGER , 70% effective rating, available with special coatings, features and adaptations for larger applications; 208/230V, 1 phase, 60 Hz is standard; some units are available in 115V; complete design service available
61420 *	EZA-1570	<i>Same as above</i>
68521 *	EZA-2270	<i>Same as above</i>
68525 *	EZA-3070	<i>Same as above</i>
89727 *	EZA-4070	<i>Same as above</i>
38324 *	EZA-985	<i>Same as above</i> , but 85% effective rating
24926 *	EZA-1585	<i>Same as above</i>
25514 *	EZA-2285	<i>Same as above</i>
68526 *	EZA-3085	<i>Same as above</i>
68528 *	EZA-4085	<i>Same as above</i>

EXHAUST COATING OPTIONS

68533 *	--	EXHAUST COATING OPTION , epoxy, for protection of aluminum mildly corrosive environments up to 150°F
68534 *	--	<i>Same as above</i> , but for EZA-1570
68535 *	--	<i>Same as above</i> , but for EZA-2270
68536 *	--	<i>Same as above</i> , but for EZA-3070
68537 *	--	<i>Same as above</i> , but for EZA-4070

CONTROLS

9694	R8239A1052	HONEYWELL FAN RELAY , 120/24 volt, used to interlock all controls and switches to exchanger in 24V
625910	16E09-101	WHITE-RODGERS ELECTRONIC TEMPERATURE CONTROL , -29°F-140°F operating range, multiple input voltages, electronic temperature accuracy, adjustable anti-short cycle delay, setpoint locking function

FOR SPECIFICATIONS, SEE PAGE 518.1

FOR ADDITIONAL INFORMATION, VISIT THE MUNTERS WEBSITE AT www.munters.com

E-Z AIRE

AIR-TO-AIR HEAT EXCHANGER

SPECIFICATIONS



	EZA-970	EZA-985	EZA-1570	EZA-1585	EZA-2270	EZA-2285
Effective Rating	70%	85%	70%	85%	70%	85%
Dimensions (L x W x H)	68" x 35" x 18"	92" x 35" x 18"	68" x 43" x 22"	92" x 43" x 22"	72" x 43" x 29"	96" x 43" x 29"
Motor Size (208/230V, 1 ph)	(2) .16 HP	(2) .16 HP	(2) .275 HP	(2) .275 HP	(2) .644 HP	(2) .644 HP
Motor Size (for 115V)	(2) .25 HP	(2) .25 HP	(2) .50 HP	(2) .50 HP	(2) .75 HP	(2) .75 HP
Rated Air Flow/CFM-Free Air						
Low Speed	700	615	1067	940	1565	1370
Med Speed	800	690	1330	1145	1955	1680
Hi Speed	900	765	1500	1275	2200	1870
Condensate Drain	(2) 3/4" FPT	(2) 3/4" FPT	(2) 3/4" FPT	(2) 3/4" FPT	(2) 3/4" FPT	(2) 3/4" FPT

	EZA-3070	EZA-3085	EZA-4070	EZA-4085
Effective Rating	70%	85%	70%	85%
Dimensions (L x W x H)	80" x 43" x 48"	104" x 43" x 48"	108" x 67" x 55"	108" x 67" x 55"
Motor Size (208/230V, 1 ph)	(2) 1.5 HP	(2) 1.5 HP	(2) 3HP	(2) 3HP
Rated Air Flow/CFM-Free Air				
Low Speed	N/A	N/A	N/A	N/A
Med Speed	N/A	N/A	N/A	N/A
Hi Speed	3100	2850	4000	4000
Condensate Drain	(2) 3/4" FPT	(2) 3/4" FPT	(2) 3/4" FPT	(2) 3/4" FPT

FOR ADDITIONAL INFORMATION, VISIT THE MUNTERS WEBSITE AT www.munters.com

RENEWAIRE

ENERGY RECOVERY VENTILATORS (ERV)



- May be mounted in any orientation
- Wide range of airflow and static capacities (†)
- Continuous moisture transfer
- Positive air stream separation
- No condensate pan or drain line required
- Passive frost-free design
- Central bathroom exhaust capability
- Internal 24V transformer and relay (BR130 and EV130-300)
- Low voltage control accessories available
- Breeze models — furnace direct-mount with proportional runtime control and terminals for furnace interconnect
- Integral mounting flanges and bracket
- Latched/hinged door for easy access
- MERV 8 filters are standard
- **All units require appropriate sidewall vent terminations**
- Experienced factory technical support
- HVI certified (BR130, EV130-300)
- ARI certified (HE07IN)
- Standard motor voltages (◆): BR130, EV130-EV300 = 120V
HE07IN = 208/230V

RESIDENTIAL WARRANTY: COMMERCIAL WARRANTY:

- 5 year parts
- 2-year parts
- 10 year core

ID ORDER#	MODEL#	AIRFLOW CFM (†)	COLLAR SIZE (††)	UNIT SIZE (W x D x H)	NOMINAL FILTER SIZE (†††)
BREEZE MODELS					
445515	BR130	50-140	6" or 8" rd	19-1/4" x 33-1/2" x 13-1/2"	10-1/2" x 10-1/2" x 1"
RESIDENTIAL INDOOR DUCTED MODELS					
668785	EV90	40-110	6" or 8" dual conn.	9-5/8" x 10-1/2" x 1"	11-3/4" x 22-1/2" x 23-3/4"
445504	EV130	50-140	6" or 8" rd	13-1/4" x 33-1/2" x 20"	10-1/2" x 10-1/2" x 1"
445516	EV200	100-200	6" or 8" rd	24" x 33-1/2" x 20"	10-1/2" x 21-3/4" x 1"
445618	EV300	150-300	8" oval	24" x 33-3/4" x 20"	10-1/2" x 21-3/4" x 1"
COMMERCIAL INDOOR DUCTED MODELS — ECM					
776922	HE07IN	166-694	(††)	--	--

FOR ACCESSORIES, SEE PAGE 519.1

**FOR ADDITIONAL INFORMATION, VISIT THE
RENEWAIRE WEBSITE AT www.renewaire.com**

(†): For efficiency and airflow ratings as well as additional information, please visit the Renewaire website at www.renewaire.com. Unit airflow is determined by ESP.

(††): 10" round and 12" x 8" duct transition kits available for HE07IN — see page 519.1.

(†††): Each unit ships with (2) filters.

(◆): Other options are available — call our office for more information.

RENEWAIRE ACCESSORIES



ID ORDER#	MODEL#	DESCRIPTION	* = SPECIAL ORDER ITEM
CONTROLS			
585863	PTL	PERCENTAGE TIMER CONTROL , 2-wire, proportional, for stand-alone units EV70-300 (not for use with HE07IN); 2 year warranty	
460204	FM	<i>Same as above</i> , but 6-wire with furnace interlock; may be used for EV70-300 units and HE07IN units	
460205	PBL	PUSH BUTTON OVERRIDE ADD-ON ACCESSORY , for PTL and FM timers; must have PTL or FM control to operate; 2 year warranty	
455596 *	TC7D-W	DIGITAL TIME CLOCK FOR COMMERCIAL APPLICATIONS , (HE07IN and larger) 24V, up to 8 on/off cycles per day or 56 per week, wall-mount, fits any 4" x 4" electrical box, battery backup	
BACKDRAFT DAMPERS			
585865	BD6	BACKDRAFT DAMPER , 6"	
446581	BD8	<i>Same as above</i> , but 8"	
468044	BD10	<i>Same as above</i> , but 10"	
455642 *	BD12	<i>Same as above</i> , but 12"	
WALL CAPS			
586432 *	VB106	VINYL WALL CAP , brown, 6"	
586431 *	VW106	<i>Same as above</i> , but white	
584363 *	VT8	<i>Same as above</i> , but taupe and 8", for EV200 or EV300 (Note: EV300 requires 8")	
586435 *	FA8-2	METAL WALL CAP , 8", galvanized (paintable)	
468045 *	FA10-1	<i>Same as above</i> , but 10" and galvanized	
455599 *	FA12-1	<i>Same as above</i> , but 12" and galvanized	
586430 *	VW12X8	FLUSH-MOUNT METAL WALL CAP , 12" x 12-8"	
586429 *	VW12X12	<i>Same as above</i> , but 12" x 12-10"	
EV450IN OPTIONAL DUCT CONNECTIONS			
456463	45EVT10	10" ROUND DUCT TRANSITION KIT , for HE07IN, 2 per kit	
543122 *	45EVDF	12" x 8" RECTANGULAR FLANGE KIT , for HE07IN, 2 per kit	

FOR ADDITIONAL INFORMATION, VISIT THE
RENEWAIRE WEBSITE AT www.renewaire.com

SEAL-TITE GALVANIZED ROUND PIPE & FITTINGS



	ID ORDER#	SIZE	CTN QTY
--	--------------	------	------------

PIPE SECTIONS, ROUND

30 GAUGE (2')



21	5" x 24"	25
5	6" x 24"	25
7	7" x 24"	25
8	8" x 24"	25
9	9" x 24"	25
10	10" x 24"	25
11	12" x 24"	25

30 GAUGE (5')

623645 (V460)	4" x 60"	10
442215 (V660)	6" x 60"	10
562675 (V760)	7" x 60"	10
623646 (V860)	8" x 60"	10
47003	10" x 60"	10
29874	12" x 60"	10

30 GAUGE (10')

159563	6" x 120"	5
--------	-----------	---

(sold by full carton only)

26 GAUGE (2')

12	3" x 24"	25
13	4" x 24"	25
14	5" x 24"	25
17	14" x 24"	20
18	16" x 24"	20

24 GAUGE (2')

38	6" x 24"	20
39	7" x 24"	20
40	8" x 24"	20
41	9" x 24"	20
42	10" x 24"	20
44	12" x 24"	20

90° ADJUSTABLE ELBOW

30 GAUGE



443403 (V430)	4"	24
443404 (V530)	5"	12
442229 (V630)	6"	12
443429 (V730)	7"	12
443430 (V830)	8"	12
72	9"	12
73	10"	12
74	12"	12

26 GAUGE

75 (V326)	3"	24
76 (V426)	4"	24
78 (V526)	5"	12
457922 (V626)	6"	12
457926 (V826)	8"	12
79	10"	12
654806	12"	12
80	14"	1
81	16"	1

90° ADJUSTABLE ELBOW (Continued)

24 GAUGE

82	6"	12
83	7"	12
84	8"	12
85	9"	12
86	10"	12
11986	12"	12
64478	18"	1

45° ADJUSTABLE ANGLE

30 GAUGE



89	6"	24
90	7"	12
91	8"	12

24 GAUGE

97	6"	12
98	7"	12
99	8"	12

151 BOOT CAP (CRIMPED)



363	3"	12
365	4"	12
366	5"	12
367	6"	24
368	7"	12
369	8"	12
370	9"	12
371	10"	12
372	12"	6
373	14"	6
374	16"	6
19087	18"	6

154 SHANTY CAPS



376	3"	12
377	4"	12
378	5"	12
379	6"	12
380	7"	12
381	8"	12
382	9"	6
11092	10"	6

**FOR ADDITIONAL INFORMATION, VISIT THE
SEAL-TITE WEBSITE AT www.sealtitehv.com**

SEAL-TITE GALVANIZED ROUND FITTINGS



ID ORDER#	SIZE	CTN QTY
-----------	------	---------

162HC DRAW BAND WITH HOSE CLAMP

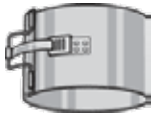

56628	6"	24
56629	7"	24
56630	8"	24

274 STARTER CONE

16732	6"	1
16733	8"	1

120 VERTICAL DRAFT DIVERTER

166	4"	1
167	5"	1
168	6"	1
169	7"	1
171	8"	1

133 TAPERED REDUCER (NO CRIMP, 8" LONG)



26 GAUGE	ID ORDER#	SIZE	CTN QTY
	245621	4" x 3"	24
	443530	5" x 3"	12
	443502	5" x 4"	12
	249712	6" x 4"	12
	353	6" x 5"	12
	443416	7" x 4"	1
	443531	7" x 5"	1
	137547	7" x 6"	12
	354	8" x 6"	12
	173992	8" x 7"	12
	137548	10" x 6"	1
	137549	10" x 8"	12
	137550	12" x 10"	1
	152552	14" x 12"	1
	152553	16" x 14"	1
	152554	18" x 16"	1

146 WYE BRANCHES (A x B x C)

30 GAUGE	ID ORDER#	SIZE	CTN QTY
	355	8" x 6" x 6"	6
	356	10" x 8" x 8"	6

26 GAUGE	ID ORDER#	SIZE	CTN QTY
	159648	6" x 4" x 4"	1



172 TOP "A" COLLAR (CRIMPED)



ID ORDER#	SIZE	CTN QTY
-----------	------	---------

388	3"	12
389	4"	12
390	5"	12
391	6"	24
392	7"	24
393	8"	24
394	9"	12
395	10"	12
396	12"	12
397	14"	12
398	16"	1
399	18"	1

219 SMOKE PIPE TEE



26 GAUGE	ID ORDER#	SIZE	CTN QTY
	415	3"	1
	416	4"	1
24 GAUGE	417	5"	1
	418	6"	1
	419	7"	1
	420	8"	1
	424	9"	1
	425	10"	1
	426	12"	1
	427	14"	1
	428	16"	1

224 WYE BRANCHES (A x B x C)



30 GAUGE	ID ORDER#	SIZE	CTN QTY
	16873	6" x 6" x 6"	6
	22424	8" x 6" x 6"	6
	16874	8" x 8" x 8"	6
	22358	10" x 8" x 8"	6

FOR ADDITIONAL INFORMATION, VISIT THE
SEAL-TITE WEBSITE AT www.sealtitehvac.com

SEAL-TITE GALVANIZED ROUND FITTINGS



	ID ORDER#	SIZE	CTN QTY
233 SHORT REDUCER (NO CRIMP)			
	446	4" x 3"	24
	447	5" x 3"	12
	448	6" x 3"	12
	449	7" x 3"	24
	11095	5" x 4"	12
	451	6" x 4"	12
	85143	7" x 4"	1
	453	8" x 4"	1
	455	6" x 5"	12
	456	7" x 5"	1
	457	7" x 6"	12
	458	8" x 6"	12
	459	9" x 6"	1
	460	10" x 6"	12
	461	8" x 7"	12
	462	9" x 7"	1
	463	10" x 7"	1
	464	9" x 8"	1
	465	10" x 8"	12
466	12" x 8"	12	
467	10" x 9"	1	
468	12" x 10"	1	
469	14" x 12"	1	

248 RETURN AIR 90° ELBOW (WITH FILTER & RACK)

68034	24" x 16"-24" x 10"	1
-------	---------------------	---

324 FLUE WYE (ADJ. BRANCH)

	471	5" x 4" x 3"	12
	443399	5" x 4" x 4"	12
	472	6" x 4" x 3"	12
	473	6" x 5" x 3"	12
	474	6" x 5" x 4"	12
	476	7" x 6" x 3"	12
	477	7" x 6" x 4"	12

2223 FREE AIR INTAKE

	743	4"	12
	745	6"	12
	746	8"	12
	238170	10"	1

50 DUCT REGISTER BOX

	105	6" x 10"	1
---	-----	----------	---

1170 REGISTER PAN

496	8" x 12" - 8"	12
-----	---------------	----

1260S ADJUSTABLE TAKE-OFF

	442230	7" - 6"	18
	28550	8" - 7"	18

1261 TOP TAKE-OFF

	617	6" x 10" - 6"	12
	618	6" x 12" - 7"	12

1262-2 DOUBLE TAKE-OFF

619	7" x 9" - 6"	6
-----	--------------	---

1264 ADJUSTABLE TAKE-OFF

	623	6" x 10" - 6"	20
	624	6" x 12" - 7"	12
	625	6" x 14" - 8"	6
	627	7" x 16" - 10"	4
	628	7" x 20" - 12"	1
	629	7" x 24" - 14"	1



1265 TAKE-OFF COLLAR

	630	6" x 6" - 6"	12
	631	7" x 7" - 7"	12
	632	7" x 8" - 8"	12

**FOR ADDITIONAL INFORMATION, VISIT THE
SEAL-TITE WEBSITE AT www.sealtitehvac.com**

SEAL-TITE GALVANIZED ROUND FITTINGS

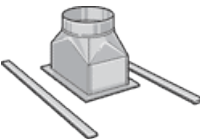

ID ORDER#	SIZE	CTN QTY
1276 EXTENDED 90° ELBOW BOOT		
715	2-1/4" x 12" - 6"	1
1277 45° OFFSET BOOT		
719	2-1/4" x 12" - 6"	1
1279 BASEMENT REGISTER BOOT WITH EARS		
 722	6" x 10" - 6"	6
1286 CEILING ("DANA") BOX		
 32229	6" x 6" - 6"	1
11988	6" x 12" - 6"	1
11670	8" x 8" - 6"	1
12158	8" x 12" - 8"	1
11669	10" x 10" - 8"	1
11672	12" x 12" - 10"	1
32956	14" x 14" - 10"	6
1286V90 CEILING BOX (with turning vane)		
69352	6" x 6" - 6"	1
69353	6" x 12" - 6"	1
69354	8" x 8" - 6"	1
69355	8" x 12" - 8"	1
69356	10" x 10" - 8"	1
69357	12" x 12" - 10"	1
69358	14" x 14" - 10"	1
1370 UNIVERSAL BOOT (STRAIGHT)		
 634	2-1/4" x 10" - 6"	12
635	2-1/4" x 12" - 6"	12
636	2-1/4" x 12" - 7"	12
637	4" x 10" - 6"	12
638	4" x 12" - 6"	12
639	4" x 12" - 7"	12
80542	4" x 14" - 7"	12
641	6" x 10" - 6"	12
642	6" x 10" - 7"	12
643	6" x 12" - 7"	12
644	6" x 12" - 8"	12
24950	6" x 14" - 8"	6

1373 END BOOT, CENTER

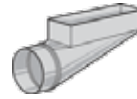

ID ORDER#	SIZE	CTN QTY
625494	2-1/4" x 10" - 6"	12
625676	2-1/4" x 12" - 6"	12
680	4" x 10" - 6"	12
681	4" x 12" - 6"	12
682	4" x 12" - 7"	12
141195	4" x 14" - 6"	6
683	6" x 10" - 6"	12

1373L END BOOT, LEFT HAND

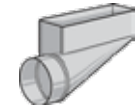

ID ORDER#	SIZE	CTN QTY
(1273L) 28809	2-1/4" x 10" - 6"	12
684	2-1/4" x 12" - 6"	12
686	4" x 10" - 6"	12
687	4" x 12" - 6"	12

1373R END BOOT, RIGHT HAND

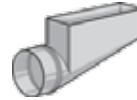

ID ORDER#	SIZE	CTN QTY
(1273R) 28808	2-1/4" x 10" - 6"	12
688	2-1/4" x 12" - 6"	12
694	4" x 10" - 6"	12
695	4" x 12" - 6"	12

1374 90° ELBOW BOOT

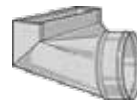

ID ORDER#	SIZE	CTN QTY
696	2-1/4" x 10" - 6"	12
697	2-1/4" x 12" - 6"	12
699	2-1/4" x 14" - 7"	12
700	4" x 10" - 6"	12
701	4" x 12" - 6"	12
703	4" x 12" - 7"	12
705	4" x 14" - 7"	6
707	6" x 10" - 6"	6
446621	6" x 10" - 7"	6
(1274) 708	6" x 10" - 8"	6
709	6" x 12" - 7"	6
634920	6" x 12" - 8"	6
712	6" x 14" - 8"	6

**FOR ADDITIONAL INFORMATION, VISIT THE
SEAL-TITE WEBSITE AT www.sealtitehv.com**

SEAL-TITE GALVANIZED ROUND FITTINGS



ID ORDER#	SIZE	CTN QTY
-----------	------	---------

1564 ADJ. TAKE-OFF, DUCTBOARD



724	6" x 10" - 6"	12
37436	6" x 12" - 7"	12
742	6" x 14" - 8"	6

1726 SHEET METAL TABBED COLLAR FOR FLEXDUCT

(extra long 6" collar for easy banding)



36569	6"	24
36570	7"	24
36571	8"	24
36573	10"	12
36574	12"	12
36575	14"	12
36576	16"	6

173 SHEET METAL TABBED COLLAR FOR FLEXDUCT (WITH DAMPER)

(extra long 6" collar for easy banding)



716673	6"	12
716672 *	7"	12
716671	8"	12
716668 *	10"	12
716669 *	12"	12
716670 *	14"	12

1727 TABBED DUCTBOARD TAKEOFF

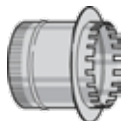

187396	6"	24
443402	7"	24
187397	8"	24
187398	10"	12
187399	12"	12
187400	14"	6
188141	16"	6

1728 TABBED DUCTBOARD TAKEOFF (WITH DAMPER)

587944	6"	24
587945	7"	24
587946	8"	12
587948	10"	12
587956	12"	12
588160	14"	12

1732 DAMPER COLLAR WITH SCOOP



ID ORDER#	SIZE	CTN QTY
85136	6"	12
85137	7"	24
85138	8"	12
85139	10"	12
85140	12"	6

1760S DUCTBOARD TAKEOFF WITH DAMPER



127075	7" - 6"	18
127076	9" - 8"	12

FOR ADDITIONAL INFORMATION, VISIT THE SEAL-TITE WEBSITE AT www.sealtitehvac.com

* = SPECIAL ORDER ITEM

SEAL-TITE GALVANIZED FLAT DUCT & FITTINGS

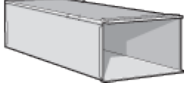

	ID ORDER#	SIZE	CTN QTY	
FLAT DUCT				
48" Length 	78216	8" x 8"	5	
	78217	10" x 8"	5	
	78218	12" x 8"	5	
	78219	14" x 8"	5	
	78220	16" x 8"	5	
	78221	18" x 8"	5	
	78224	20" x 8"	5	
	78223	24" x 8"	5	
	147202	20" x 10"	5	
	187394	24" x 10"	5	
60" Length	755	8" x 8"	5	
	51018	10" x 8"	5	
	756	12" x 8"	5	
	51019	14" x 8"	5	
	757	16" x 8"	5	
	37301	18" x 8"	5	
	758	20" x 8"	5	
	51020	22" x 8"	5	
	759	24" x 8"	5	
	760	24" x 10"	5	
	761	28" x 10"	5	
	51435	24" x 12"	5	
	ID ORDER#	SIZE	COLLAR SIZE	CTN QTY

1200 STARTING COLLAR

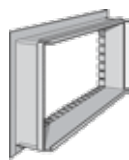

497	8" x 8"	--	1
51366	10" x 8"	--	1
498	12" x 8"	--	1
51367	14" x 8"	--	1
499	16" x 8"	--	1
51368	18" x 8"	--	1
500	20" x 8"	--	1
501	24" x 8"	--	1
81589	20" x 10"	--	1
503	24" x 10"	--	1
504	28" x 10"	--	1
51424	24" x 12"	--	1

1202 STARTING COLLAR WITH 2" RISE WITH DRIVES

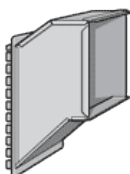

52359	8" x 8"	--	1
51371	10" x 8"	--	1
508	12" x 8"	--	1
51372	14" x 8"	--	1
509	16" x 8"	--	1
51373	18" x 8"	--	1
510	20" x 8"	--	1
511	24" x 8"	--	1
512	24" x 10"	--	1
513	28" x 10"	--	1

1203 TRANSITION STARTING COLLAR WITH 2" RISE

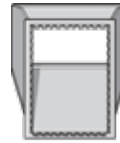

514	12" x 8"	10" x 10"	1
51376	14" x 8"	12" x 10"	1
515	16" x 8"	12" x 11"	1
11096	18" x 8"	12" x 12"	1
516	20" x 8"	14" x 12"	1
51377	22" x 8"	14" x 13"	1
517	24" x 8"	14" x 14"	1
81588	20" x 10"	14" x 14-1/4"	1
518	24" x 10"	14" x 16"	1
519	28" x 10"	14" x 18"	1
51426	24" x 12"	14" x 18"	1

1203L TRANSITION STARTING COLLAR WITH 2" RISE & TRANSITION TO LEFT

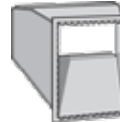

524	20" x 8" - 9"	--	1
525	24" x 8" - 9"	--	1

1203R TRANSITION STARTING COLLAR WITH 2" RISE & TRANSITION TO RIGHT

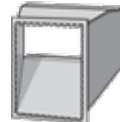

520	20" x 8" - 6"	14" x 12"	1
521	24" x 8" - 6"	14" x 14"	1

1204 45° ANGLE STRAIT UP TO DUCT

48542	12" x 8"	--	1
48543	16" x 8"	--	1
48544	20" x 8"	--	1

ID ORDER#	SIZE	CTN QTY
-----------	------	---------







149 VERTICAL 90° RETURN AIR TAKEOFF

364	12" x 8"	1
360	16" x 8"	1
361	20" x 8"	1
362	24" x 8"	1

**FOR ADDITIONAL INFORMATION, VISIT THE
SEAL-TITE WEBSITE AT www.sealtitehvac.com**

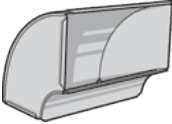
SEAL-TITE GALVANIZED FLAT DUCT FITTINGS

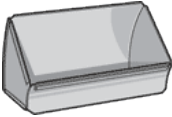

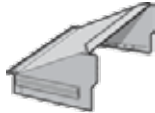
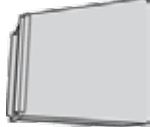
1210 END CAP				1245 FLAT 45° ANGLE WITH DRIVES (Continued)			
ID ORDER#	SIZE	CTN QTY		ID ORDER#	SIZE	CTN QTY	
	528	8" x 8"	1		596	20" x 8"	1
	51378	10" x 8"	1		598	24" x 8"	1
	529	12" x 8"	1		81593	20" x 10"	1
	51379	14" x 8"	1		599	24" x 10"	1
	530	16" x 8"	1		600	28" x 10"	1
	51380	18" x 8"	1		51431	24" x 12"	1
	531	20" x 8"	1				
	51381	22" x 8"	1				
	532	24" x 8"	1				
	81590	20" x 10"	1				
	533	24" x 10"	1				
	534	28" x 10"	1				
	51428	24" x 12"	1				
1240 90° ELBOW (VERTICAL)				1246 FLAT 90° ELBOW WITH DRIVES			
	570	8" x 8"	1		604	8" x 8"	1
	51382	10" x 8"	1		51395	10" x 8"	1
	571	12" x 8"	1		605	12" x 8"	1
	51383	14" x 8"	1		51396	14" x 8"	1
	572	16" x 8"	1		606	16" x 8"	1
	51384	18" x 8"	1		51397	18" x 8"	1
	573	20" x 8"	1		607	20" x 8"	1
	574	24" x 8"	1		608	24" x 8"	1
	81591	20" x 10"	1		81594	20" x 10"	1
	575	24" x 10"	1		609	24" x 10"	1
	576	28" x 10"	1		610	28" x 10"	1
	51429	24" x 12"	1		51432	24" x 12"	1
1241 45° ANGLE (VERTICAL)				52 DUCT ADAPTER, REDUCER			
	581	8" x 8"	1		202114	4" x 10"	24
	51386	10" x 8"	1				
	582	12" x 8"	1				
	51388	14" x 8"	1				
	583	16" x 8"	1				
	51390	18" x 8"	1				
	584	20" x 8"	1				
	585	24" x 8"	1				
	81592	20" x 10"	1				
	586	24" x 10"	1				
	587	28" x 10"	1				
	51430	24" x 12"	1				
1245 FLAT 45° ANGLE WITH DRIVES				187 DUCT ADAPTER, REDUCER			
	593	8" x 8"	1		403	2" x 8"	24
	51392	10" x 8"	1		404	4" x 8"	24
	594	12" x 8"	1		51017	6" x 8"	24
	51393	14" x 8"	1		405	8" x 8"	24
	595	16" x 8"	1				
	597	18" x 8"	1				
				1251 TAPERED REDUCER			
					25434	16" x 8" - 12" x 8"	1
					25433	20" x 8" - 12" x 8"	1
					74037	20" x 8" - 16" x 8"	1
					25432	24" x 8" - 16" x 8"	1
					74036	24" x 8" - 20" x 8"	1
				1263 TRANSITION REDUCER			
					620	20" x 10" - 20" x 8"	1
					621	24" x 10" - 20" x 8"	1
					51434	24" x 10" - 24" x 8"	1
					622	28" x 10" - 24" x 8"	1
					51433	24" x 12" - 24" x 10"	1

**FOR ADDITIONAL INFORMATION, VISIT THE
SEAL-TITE WEBSITE AT www.sealtitehvac.com**

SEAL-TITE GALVANIZED DUCT FITTINGS



ID ORDER#	SIZE	CTN QTY
-----------	------	---------

81 PLENUM:

Made to fit flange dimensions on unit with "S" hooks inside, 26 gauge, sliding seam construction



601063	22-7/8" x 19" x 48" (for Nortek G7 "D" cabinet)	1
--------	--	---

82 PLENUM

Five-piece plenum, 26 gauge, adjustable, can be trimmed down to fit flange on unit



77057	24" x 24" x 48"	1
-------	-----------------	---

207-17 SINGLE JOIST PANNING (box of 20)

407	35-3/8" x 16-1/2"	1
-----	-------------------	---

208-33 DOUBLE JOIST PANNING (box of 10)

408	35-3/8" x 33"	1
-----	---------------	---

209 STANDARD "S" LOCK



409	60"	10
-----	-----	----

212 PLENUM CORNER



410	60"	50
-----	-----	----

213 DRIVE CLEAT



411	8"	200
412	10"	100
62950	12"	100
11093	60"	25

215 RIGID "S" LOCK

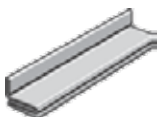

11094	60"	25
-------	-----	----

248 RETURN AIR DROP 90° Elbow with filter rack
(Note: Filter not included.)



68034	24" x 16" - 24" x 10"	1
-------	-----------------------	---

81100 RETURN AIR KIT

Complete package consists of the following: (1) #1200 starter collar; (2) 32" duct sections B/L; (1) #248 connector with top filter slot (filter included); (6) #213 drive straps



68810	20" x 16" - 20" x 10"	1
-------	-----------------------	---

187395	20" x 14" - 20" x 10"	1
--------	-----------------------	---

81100SF RETURN AIR KIT

Same package as above but with a #248 connector with side filter slot (filter not included)

206298	24" x 14" - 24" x 10"	1
--------	-----------------------	---

253 FURNACE FILTER RACK

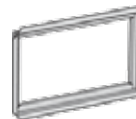

48115	14" x 25"	6
41970 *	16" x 25"	6

925FD SUPPORT BOX WITH FILTER RACK

753817	39" x 28-1/2" x 15"	1
--------	---------------------	---





Note: A small opening cutout in the top allows the contractor to size the duct opening.





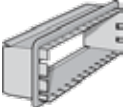

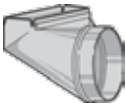
* = SPECIAL ORDER ITEM

FOR ADDITIONAL INFORMATION, VISIT THE
SEAL-TITE WEBSITE AT www.sealtitehvac.com

SEAL-TITE GALVANIZED WALLSTACK & FITTINGS

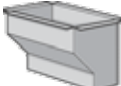
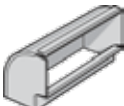









	ID ORDER#	SIZE	CTN QTY
WALLSTACK			
24" SECTION 	762	2-1/4" x 12"	20
	764	3-1/4" x 10"	20
	765	3-1/4" x 12"	20
60" SECTION	767	2-1/4" x 12"	10
	775	3-1/4" x 10"	10
	777	3-1/4" x 12"	10
100" SECTION	11668	2-1/4" x 12"	5
	11667	3-1/4" x 10"	5
1200 TAKE-OFF COLLAR			
	506	3-1/4" x 10"	1
	507	3-1/4" x 12"	1
1214 UNIVERSAL BOOT, STRAIGHT			
	535	2-1/4" x 12" - 6"	12
	537	3-1/4" x 10" - 6"	12
	538	3-1/4" x 10" - 7"	12
	539	3-1/4" x 12" - 6"	12
	540	3-1/4" x 12" - 7"	12
1218 90° ELBOW BOOT			
	542	2-1/4" x 12" - 6"	12
	544	3-1/4" x 10" - 6"	12
	545	3-1/4" x 10" - 7"	12
	547	3-1/4" x 12" - 6"	12
	548	3-1/4" x 12" - 7"	12
	549	3-1/4" x 12" - 8"	6
1219 END BOOT, CENTER			
	551	3-1/4" x 10" - 6"	12
	550	2-1/4" x 12" - 6"	12
	553	3-1/4" x 12" - 6"	12
	554	3-1/4" x 12" - 7"	12
	555	3-1/4" x 12" - 8"	6

	ID ORDER#	SIZE	CTN QTY
1230LE SINGLE STACK HEAD (LONG, WITH EARS)			
	48546	2-1/4" x 10" - 6" x 10"	1
	48547	2-1/4" x 12" - 6" x 12"	1
	48549	3-1/4" x 10" - 4" x 10"	1
	48548	3-1/4" x 10" - 6" x 10"	1
	48550	3-1/4" x 12" - 6" x 12"	1
1232 DOUBLE STACK HEAD			
	563	3-1/4" x 10" - 6" x 10"	1
	564	3-1/4" x 12" - 6" x 12"	1
1234 STACK HEAD, FLOOR BOX			
	565	2-1/4" x 12" - 4" x 12"	1
	566	3-1/4" x 10" - 4" x 10"	1
	567	3-1/4" x 10" - 6" x 10"	1
	568	3-1/4" x 12" - 4" x 12"	1
	569	3-1/4" x 12" - 6" x 12"	1
1240S VERTICAL 90° ELBOW			
	577	2-1/4" x 12"	1
	579	3-1/4" x 10"	1
	580	3-1/4" x 12"	1
1241S VERTICAL 45° ANGLE			
	588	2-1/4" x 12"	1
	589	3-1/4" x 10"	1
	591	3-1/4" x 12"	1
1245S FLAT 45° ANGLE			
	602	3-1/4" x 10"	1
1246S FLAT 90° ELBOW			
	611	2-1/4" x 12"	1
	613	3-1/4" x 10"	1
	614	3-1/4" x 12"	1
1283 TOEKICK OVAL BOOT			
	467085	2-1/4" x 12" - 6"	12

FOR ADDITIONAL INFORMATION, VISIT THE SEAL-TITE WEBSITE AT www.sealtitehv.com

SEAL-TITE GALVANIZED PIPE & OVAL FITTINGS



	ID ORDER#	SIZE	CTN QTY
4100 OVAL PIPE — 100" Section			
	100" SECTION 28904	6"	5
	82092	7"	5
4130 HORIZONTAL 90° ELBOW			
	28916	6"	12
	82232	7"	12
4131 HORIZONTAL 45° ANGLE			
	28918	6"	12
	82233	7"	12
4140 VERTICAL 90° ELBOW			
	28917	6"	12
	37659	7"	12
4141 VERTICAL 45° ANGLE			
	28919	6"	12
	37658	7"	12
4212 BOOT ADAPTERS			
	28906	2-1/4" x 12" x 6"	12
	28910	3-1/4" x 12" x 6"	12
4213 ROUND TO OVAL ADAPTER (CRIMPED)			
	28913	6"	12
	37303	7"	12
4235 OVAL STACKHEAD WITH 9" THROAT (=4238)			
	28920	4" x 10" - 6"	12
	28922	6" x 10" - 6"	6
	28923	6" x 12" - 6"	6
	37656	6" x 12" - 7"	12
4244NC ROUND TO OVAL 90° BOOT (NO CRIMP)			
	187403	6"	12
	187405	7"	12

	ID ORDER#	SIZE	CTN QTY
4245NC ROUND TO OVAL 90° BOOT (NO CRIMP)			
	53759	6"	12
	37661	7"	12
4246NC OVAL REVERSE BOOT (NO CRIMP)			
	53765	6"	12
4247NC ROUND TO OVAL END BOOT (NO CRIMP)			
	54769	6"	12
	37660	7"	12
4248NC ROUND TO OVAL STRAIGHT BOOT (NO CRIMP)			
	53770	6"	12
	82201	7"	12
4261 OVAL TOP TAKEOFF			
	28914	6" x 10" - 6"	12
4265 OVAL SIDE TAKEOFF			
	28915	6" x 6" - 6"	12
4270 ANGLE REGISTER BOX			
	28925	4" x 10" - 6"	12
4271 OVAL 90° REGISTER BOX			
	82093	4" x 12" - 7"	12
4274 REGISTER BOOT			
	28948	4" x 10" - 6"	12

**FOR ADDITIONAL INFORMATION, VISIT THE
SEAL-TITE WEBSITE AT www.sealtitehvac.com**

SOUTHWARK PCD DUCT & FITTINGS



	ID	MODEL#	SIZE
	ORDER#	MODEL#	SIZE
PCD SHEETS			
24 gauge (4 x 1)	732453	UG244860	48" x 60"
PCD DUCT			
26 gauge	5950	UG10626	6" x 10'
	5951	UG10826	8" x 10'
	5952	UG101026	10" x 10'
	5953	UG101226	12" x 10'
	5954	UG101426	14" x 10'
24 gauge	5955	UG101624	16" x 10'
	5956	UG101824	18" x 10'
PCD CONNECTORS			
26 gauge	5957	UGCON626	6"
	5958	UGCON826	8"
	5959	UGCON1026	10"
	5960	UGCON1226	12"
24 gauge	5961	UGCON1424	14"
	5962	UGCON1624	16"
	5963	UGCON1824	18"
PCD 90° ELBOWS			
26 gauge	5964	UG90626	6"
	5965	UG90826	8"
	5966	UG901026	10"
	5967	UG901226	12"
24 gauge	5968	UG901424	14"
	5969	UG901624	16"
	5970	UG901824	18"
PCD 45° ANGLES			
26 gauge	5971	UG45626	6"
	5972	UG45826	8"
	5973	UG451026	10"
	5974	UG451226	12"
24 gauge	5975	UG451424	14"
	5976	UG451624	16"
	5977	UG451824	18"
PCD TAPERED REDUCERS			
26 gauge	17339	UG5886	8" - 6"
	18069	UG48106	10" - 6"
	18070	UG58108	10" - 8"
	18072	UG58128	12" - 8"
	18073	UG581210	12" - 10"

	ID	MODEL#	SIZE
	ORDER#	MODEL#	SIZE
PCD TAPERED REDUCERS (continued)			
24 gauge	18074	UG581410	14" - 10"
	18075	UG581412	14" - 12"
	18076	UG581614	16" - 14"
	18077	UG581816	18" - 16"
PCD END CAPS			
26 gauge	5991	UG556	6"
	5992	UG558	8"
	5993	UG5510	10"
	5994	UG5512	12"
24 gauge	5995	UG5514	14"
PCD 90° ELBOW BOOTS			
	19359	PCD24R2126	2-1/4" x 12" - 6"
	6012	PCD24R4106	4" x 10" - 6"
	6014	PCD24R4126	4" x 12" - 6"
	6015	PCD24R4146	4" x 14" - 6"
	25950	UG24R6148	6" x 14" - 8"
PCD CENTER END BOOTS			
	32326	PCD28R2126	2-1/4" x 12" - 6"
	6025	PCD28R4106	4" x 10" - 6"
	6026	PCD28R4126	4" x 12" - 6"
	25951	PCD28R6148	6" x 14" - 8"
PCD 45° SADDLES			
	6038	UG70410	4" x 10"
	6039	UG70412	4" x 12"
PCD 90° SHOE TAPS			
	6116	UG606	6" for 6" - 10" pipe
	6118	UG606A	6" for 12" - 16" pipe
	6119	UG608	8" for 8" - 12" pipe
	6121	UG608A	8" for 14" - 18" pipe
PCD TAPE			
	6126	--	2" x 108'
PCD TOUCH-UP PAINT			
	732454	UGSPRAY	12 oz can

FOR ADDITIONAL INFORMATION, VISIT THE SOUTHWARK WEBSITE AT www.southwarkmetal.com

SOUTHWARK GALVANIZED SPIRAL DUCT & FITTINGS





	ID ORDER#	MODEL#	SIZE	
GALVANIZED SPIRAL DUCT				
	26 gauge	26422	SP10626	6" x 10'
		26420	SP10826	8" x 10'
		26454	SP101026	10" x 10'
		26410	SP101226	12" x 10'
		26409	SP101426	14" x 10'
24 gauge	26408	SP101624	16" x 10'	
	26437	SP101824	18" x 10'	

	ID ORDER#	MODEL#	SIZE	
GALVANIZED SPIRAL CONNECTORS				
	26 gauge	29402	SPCON626	6"
		29326	SPCON826	8"
		29325	SPCON1026	10"
		26439	SPCON1226	12"
24 gauge	29324	SPCON1424	14"	
	29323	SPCON1624	16"	
	26438	SPCON1824	18"	

	ID ORDER#	MODEL#	SIZE	
GALVANIZED SPIRAL STANDARD 90° ELBOW (Short Throat)				
	26 gauge	26459	SP90626	6"
		26460	SP90826	8"
		26461	SP901026	10"
		26462	SP901226	12"
24 gauge	26465	SP901424	14"	
	26412	SP901624	16"	
	26463	SP901824	18"	

	ID ORDER#	MODEL#	SIZE	
GALVANIZED SPIRAL STANDARD 45° ANGLE				
	26 gauge	29352	SP45826	8"
		29351	SP451026	10"
		154446	SP451226	12"
24 gauge	129141	SP451424	14"	
	26414	SP451624	16"	

	ID ORDER#	MODEL#	SIZE	
GALVANIZED SPIRAL TAPERED REDUCERS				
	26 gauge	26417	SP5886	8" x 6"
		29337	SP58108	10" x 8"
		29329	SP581210	12" x 10"
24 gauge	29332	SP581410	14" x 10"	
	26416	SP581412	14" x 12"	
	209036	SP581612	16" x 12"	
	26415	SP581614	16" x 14"	
	34069	SP581814	18" x 14"	
	40828	SP581816	18" x 16"	

	ID ORDER#	MODEL#	SIZE	
GALVANIZED SPIRAL 90° SHOE TAPS				
	26 gauge	33438	SP606	6" for 6"-10"
		29348	SP606A	6" for 12"-16"
		29346	SP608	8" for 8"-12"
		29347	SP608A	8" for 14"-18"
		29344	SP610	10" for 10"-14"
		26419	SP610A	10" for 16"-20"



FOR ADDITIONAL INFORMATION, VISIT THE SOUTHWARK WEBSITE AT www.southwarkmetal.com

SOUTHWARK



PREFAB SHEET METAL DUCT & FITTINGS

GALVANIZED ROUND



	ID	MODEL#	SIZE	CTN		
	ORDER#	MODEL#	SIZE	QTY		
SNAPLOCK PIPE—ROUND						
	30 GAUGE (2')	707135	SL24530	5" x 2'	25	
		705072	SL24630	6" x 2'	25	
		707136	SL24730	7" x 2'	25	
		707137	SL24830	8" x 2'	12	
		707139	SL241030	10" x 2'	12	
		707140	SL241230	12" x 2'	10	
30 GAUGE (5')		705079	SL60430	4" x 5'	10	
		705080	SL60530	5" x 5'	10	
		625202	SL60630	6" x 5'	10	
		705081	SL60730	7" x 5'	10	
		705082	SL60830	8" x 5'	10	
		705084	SL601030	10" x 5'	5	
		705085	SL601230	12" x 5'	5	
	30 GAUGE (10')	705096	SL120630	6" x 10'	5	
26 GAUGE (2')		705073	SL24326	3" x 2'	20	
		705074	SL24426	4" x 2'	20	
		705075	SL24526	5" x 2'	20	
		707146	SL24626	6" x 2'	20	
		705076	SL24726	7" x 2'	20	
		707149	SL241026	10" x 2'	10	
		707150	SL241226	12" x 2'	10	
		707151	SL241426	14" x 2'	10	
	26 GAUGE (5')		707183	SL60426	4" x 5'	5
			707184	SL60526	5" x 5'	10
		707185	SL60626	6" x 5'	10	
		707187	SL60826	8" x 5'	5	
		707189	SL601026	10" x 5'	5	
		707190	SL601226	12" x 5'	12	
		707191	SL601426	14" x 5'	5	
		707192	SL601626	16" x 5'	5	
24 GAUGE (2')		705077	SL24624	6" x 2'	10	
		707160	SL24824	8" x 2'	10	
		707162	SL241024	10" x 2'	10	
		707163	SL241224	12" x 2'	10	
	90° ELBOWS					
		705114	90430	4"	24	
		705115	90530	5"	12	
		625204	90630	6"	12	
		705116	90730	7"	12	
		705117	90830	8"	12	
		705119	901030	10"	12	
	28 GAUGE	714149	901228	12"	8	

90° ELBOWS (continued)

	ID	MODEL#	SIZE	CTN	
	ORDER#	MODEL#	SIZE	QTY	
	26 GAUGE	705121	90326	3"	24
		705122	90426	4"	24
		705123	90526	5"	12
		705124	90626	6"	12
		705125	90726	7"	12
		705126	90826	8"	12
		705127	901026	10"	12
		705128	901226	12"	8
		707249	901426	14"	4
		705129	901626	16"	4
24 GAUGE		707257	90724	7"	12
		707260	901024	10"	12
#16 90° VERTICAL RADIUS ELBOWS					
		707773	1688	8" x 8"	8
		705163	16108	10" x 8"	8
		705164	16128	12" x 8"	8
		705165	16148	14" x 8"	6
		705166	16168	16" x 8"	6
		705167	16188	18" x 8"	6
		705168	16208	20" x 8"	6
		707774	16228	22" x 8"	3
		705169	16248	24" x 8"	4
		707800	162410	24" x 10"	4
#17 REDUCERS					
		714164	1710888	10" x 8" - 8" x 8"	1
		714165	1712888	12" x 8" - 8" x 8"	1
		707033	17128108	12" x 8" - 10" x 8"	1
		714167	17148108	14" x 8" - 10" x 8"	1
		728032	17148128	14" x 8" - 12" x 8"	1
		714166	1716888	16" x 8" - 10" x 8"	1
		720135	17168108	16" x 8" - 8" x 8"	1
		720139	17168128	16" x 8" - 12" x 8"	1
		714160	17168148	16" x 8" - 14" x 8"	1
		720136	17188128	18" x 8" - 12" x 8"	1
		714161	17188148	18" x 8" - 14" x 8"	1
		708227	17188168	18" x 8" - 16" x 8"	1
		714162	17208148	20" x 8" - 14" x 8"	1
		708228	17208168	20" x 8" - 16" x 8"	1
		720137	17208188	20" x 8" - 18" x 8"	1
		714159	17228188	22" x 8" - 18" x 8"	1
		708229	17228208	22" x 8" - 20" x 8"	1
		714157	17248168	24" x 8" - 16" x 8"	1
	720138	17248188	24" x 8" - 18" x 8"	1	
	708230	17248208	24" x 8" - 20" x 8"	1	

FOR ADDITIONAL INFORMATION, VISIT THE SOUTHWARK WEBSITE AT www.southwarkmetal.com

SOUTHWARK

PREFAB SHEET METAL DUCT & FITTINGS

GALVANIZED ROUND



	ID	ORDER#	MODEL#	SIZE	CTN QTY
	708179	2088		8" x 8"	1
	708180	20108		10" x 8"	1
	708181	20128		12" x 8"	1
	708182	20148		14" x 8"	1
	708183	20168		16" x 8"	1
	706060	20188		18" x 8"	1
	706059	20208		20" x 8"	1
	708184	20228		22" x 8"	1
	708185	20248		24" x 8"	1
	708198	202410		24" x 10"	1

#21 END CAPS

	708112	2188		8" x 8"	1
	705191	21108		10" x 8"	1
	705192	21128		12" x 8"	1
	705193	21148		14" x 8"	1
	705194	21168		16" x 8"	1
	705195	21188		18" x 8"	1
	705196	21208		20" x 8"	1
	708126	212010		20" x 10"	1
	705197	21248		24" x 8"	1
	708128	212410		24" x 10"	1

#23 OFFSET COLLARS

	708091	23108		10" x 8"	8
	708092	23128		12" x 8"	8
	708093	23148		14" x 8"	6
	708094	23168		16" x 8"	6
	708095	23188		18" x 8"	6
	708096	23208		20" x 8"	6

#23AT TRANSITION COLLARS

	708081	23AT148		14" x 8"	8
	707031	23AT168		16" x 8"	6
	708082	23AT188		18" x 8"	6
	708083	23AT208		20" x 8"	4
	708084	23AT228		22" x 8"	4
	708085	23AT248		24" x 8"	4

#24 90° STACK BOOTS

	708577	242126	2-1/4" x 12" - 6"	12
	708580	243106	3-1/4" x 10" - 6"	12
	708585	243126	3-1/4" x 12" - 6"	12

#24R 90° REGISTER BOOTS

	705242	24R2106	2-1/4" x 10" - 6"	12
	705246	24R2126	2-1/4" x 12" - 6"	12
	705248	24R2146	2-1/4" x 14" - 6"	12
	705253	24R4106	4" x 10" - 6"	12
	705258	24R4126	4" x 12" - 6"	12
	705259	24R4127	4" x 12" - 7"	12
	705260	24R4128	4" x 12" - 8"	12
	705264	24R6106	6" x 10" - 6"	12
	705265	24R6107	6" x 10" - 7"	12
	705268	24R6127	6" x 12" - 7"	12
705269	24R6128	6" x 12" - 8"	12	
705272	24R6148	6" x 14" - 8"	12	

#27 STRAIGHT STACK BOOTS

	708596	272126	2-1/4" x 12" - 6"	12
	708599	273106	3-1/4" x 10" - 6"	12
	708604	273126	3-1/4" x 12" - 6"	12

#27R STRAIGHT REGISTER BOOTS

	705279	27R2126	2-1/4" x 12" - 6"	12
	705282	27R2147	2-1/4" x 14" - 7"	12
	705286	27R4106	4" x 10" - 6"	12
	705291	27R4126	4" x 12" - 6"	12
	705292	27R4127	4" x 12" - 7"	12
	705296	27R4148	4" x 14" - 8"	12
	705297	27R6106	6" x 10" - 6"	12
	705298	27R6107	6" x 10" - 7"	12
	705300	27R6126	6" x 12" - 6"	12
	705301	27R6127	6" x 12" - 7"	12
	705302	27R6128	6" x 12" - 8"	12
	705305	27R6148	6" x 14" - 8"	12

#28 END STACK BOOTS

	708615	282126	2-1/4" x 12" - 6"	12
	708618	283106	3-1/4" x 10" - 6"	12
	708623	283126	3-1/4" x 12" - 6"	12

FOR ADDITIONAL INFORMATION, VISIT THE SOUTHWARK WEBSITE AT www.southwarkmetal.com

SOUTHWARK

PREFAB SHEET METAL DUCT & FITTINGS

GALVANIZED ROUND



	ID	ORDER#	MODEL#	SIZE	CTN
	ORDER#	MODEL#	SIZE	CTN	QTY
	705312	28R2126	2-1/4" x 12" - 6"	12	
	705319	28R4106	4" x 10" - 6"	12	
	705324	28R4126	4" x 12" - 6"	12	
	705328	28R4147	4" x 14" - 7"	12	
	705331	28R6107	6" x 10" - 7"	12	
	705335	28R6128	6" x 12" - 8"	12	
	705338	28R6148	6" x 14" - 8"	12	

#35 DUCT REDUCERS FOR 8" DUCT

	708275	35208	2"	12
	705205	35408	4"	12
	708276	35608	6"	12
	708277	35808	8"	12

#48 PANNING

	705427	481735	17" x 35"	25
	705428	483235	32" x 35"	10
	709650*	483335	33" x 35"	10
	*(double panning)			

#52 FLUE WYES

	709332	52444	4" x 4" x 4"	12
	709334	52543	5" x 4" x 3"	12
	709335	52544	5" x 4" x 4"	12
	709337	52554	5" x 5" x 4"	12
	709339	52643	6" x 4" x 3"	12
	709340	52644	6" x 4" x 4"	12
	709341	52653	6" x 5" x 3"	12
	709342	52654	6" x 5" x 4"	12
	709345	52666	6" x 6" x 6"	12

#55 END CAPS—CRIMPED

705390	555	5"	12
705393	558	8"	12
705395	5510	10"	12

#55 END CAPS—NO CRIMP

	705376	553NC	3"	12
	705377	554NC	4"	12
	705378	555NC	5"	12
	705379	556NC	6"	12
	705380	557NC	7"	12
	705381	558NC	8"	12

#55 END CAPS—NO CRIMP (continued)

	705383	5510NC	10"	12
	705384	5512NC	12"	12
	705385	5514NC	14"	12

#58 3-PIECE REDUCERS—NO CRIMP

	705400	5843	4" x 3"	12
	705401	5853	5" x 3"	12
	705402	5854	5" x 4"	12
	705403	5863	6" x 3"	12
	705404	5864	6" x 4"	12
	705405	5865	6" x 5"	12
	705407	5874	7" x 4"	12
	705408	5875	7" x 5"	12
	705409	5876	7" x 6"	12
	709380	5884	8" x 4"	12
	705410	5885	8" x 5"	12
	705411	5886	8" x 6"	12
	705412	5887	8" x 7"	12
	705413	58108	10" x 8"	12
	709389	58126	12" x 6"	12
	705390	58128	12" x 8"	12
	705414	581210	12" x 10"	12

#62 TOP TAKEOFFS

	708738	626	6"	12
	708739	627	7"	12

#1050 TOP COLLARS—NO CRIMP

	705344	10504	4"	12
	705346	10506	6"	50
	705348	10508	8"	25
	705349	105010	10"	12
	708800	105016	16"	12

#1051 TOP COLLARS—CRIMPED

	708805	10513	3"	12
	705350	10514	4"	12
	705351	10515	5"	12
	625207	10516	6"	50
	705352	10517	7"	50
	705353	10518	8"	25
	708806	10519	9"	12
	705354	105110	10"	12
	708807	105112	12"	12
	708808	105114	14"	12
	708809	105116	16"	12

FOR ADDITIONAL INFORMATION, VISIT THE SOUTHWARK WEBSITE AT www.southwarkmetal.com

SEPTEMBER 2024

Line #5651

SOUTHWARK PREFAB SHEET METAL DUCT & FITTINGS GALVANIZED ROUND

521.5



	ID ORDER#	MODEL#	SIZE	CTN QTY
#1060 TEES				
	705369	10604	4" x 4" x 4"	12
	705374	106010	10" x 10" x 10"	6
	705375	106012	12" x 12" x 12"	1
30 GAUGE				
	709306	1060264	4" x 4" x 4"	12
	709308	1060266	6" x 6" x 6"	12
	709310	1060268	8" x 8" x 8"	6
	709312	10602610	10" x 10" x 10"	4

#1149 LONG COLLARS WITH DAMPER

708826	11496	6"	12
708827	11497	7"	12
708828	11498	8"	12
708830	114910	10"	12
708831	114912	12"	12
708832	114914	14"	6
708833	114916	16"	6

#1149S LONG COLLARS WITH SCOOP & DAMPER



708837	1149S6	6"	1
--------	--------	----	---

#EP15 ADJUSTABLE TAKEOFFS



625205	EP1576	7" - 6"	12
705341	EP1587	8" - 7"	12
705342	EP1598	9" - 8"	12

FOR ADDITIONAL INFORMATION, VISIT THE SOUTHWARK WEBSITE AT www.southwarkmetal.com

SOUTHWARK

PREFAB SHEET METAL DUCT & FITTINGS

GALVANIZED FLAT

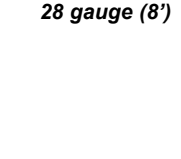

	ID	MODEL#	SIZE	CTN
	ORDER#	MODEL#	SIZE	QTY
#FLAT DUCT—2 DRIVES INCLUDED				
	705131	TD4888	8" x 8" x 48"	6
	705132	TD48108	10" x 8" x 48"	6
	627532	TD48128	12" x 8" x 48"	6
	705133	TD48148	14" x 8" x 48"	6
	627531	TD48168	16" x 8" x 48"	6
	705134	TD48188	18" x 8" x 48"	6
	705135	TD48208	20" x 8" x 48"	6
	705136	TD48228	22" x 8" x 48"	6
	705137	TD48248	24" x 8" x 48"	6
	707386	TD481210	12" x 10" x 48"	1
	707387	TD481410	14" x 10" x 48"	1
	707388	TD481610	16" x 10" x 48"	1
	707035	TD482010	20" x 10" x 48"	1
	707036	TD482410	24" x 10" x 48"	1
	707391	TD482510	25" x 10" x 48"	1

	705147	TD9688	8" x 8" x 96"	1
	705148	TD96108	10" x 8" x 96"	1
	705149	TD96128	12" x 8" x 96"	1
	705150	TD96148	14" x 8" x 96"	1
	705151	TD96168	16" x 8" x 96"	1
	705152	TD96188	18" x 8" x 96"	1
	705153	TD96208	20" x 8" x 96"	1
	705154	TD96228	22" x 8" x 96"	1
	705155	TD96248	24" x 8" x 96"	1
	707461	TD962410	24" x 10" x 96"	1

#13 45° FLAT RADIUS ANGLES

	707910	1388	8" x 8"	6
	707911	13108	10" x 8"	6
	707912	13128	12" x 8"	6
	707913	13148	14" x 8"	6
	707914	13168	16" x 8"	6
	707915	13188	18" x 8"	6
	707916	13208	20" x 8"	6
	707917	13228	22" x 8"	6
	707918	13248	24" x 8"	3

#14 90° FLAT RADIUS ELBOWS

	707975	1488	8" x 8"	8
	705177	14108	10" x 8"	8
	705178	14128	12" x 8"	6
	705179	14148	14" x 8"	3
	705180	14168	16" x 8"	3
	705181	14188	18" x 8"	3
	705182	14208	20" x 8"	3
	707976	14228	22" x 8"	3
	705183	14248	24" x 8"	3

#15 45° VERTICAL ANGLES

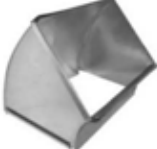
	707838	1588	8" x 8"	6
	707839	15108	10" x 8"	6
	707840	15128	12" x 8"	6
	707841	15148	14" x 8"	6
	707842	15168	16" x 8"	6
	707843	15188	18" x 8"	6
	707844	15208	20" x 8"	6
	707845	15228	22" x 8"	6
	707846	15248	24" x 8"	6
	707872	152410	24" x 10"	6

#113 45° FLAT ANGLES

	705219	1136	6"	12
	708476	1138	8"	12

#1150 LONG FLAT COLLARS

	705355	11504	4"	12
	705357	11506	6"	25
	705358	11507	7"	25
	705359	11508	8"	25
	708818	115010	10"	12
	708819	115012	12"	12
	708820	115014	14"	12
	708821	115016	16"	6
	708822	115018	18"	6

FOR ADDITIONAL INFORMATION, VISIT THE SOUTHWARK WEBSITE AT www.southwarkmetal.com

SOUTHWARK

PREFAB SHEET METAL DUCT & FITTINGS

GALVANIZED





	ID	MODEL#	SIZE	CTN
	ORDER#			QTY
	709612	6S10	9-3/4"	100
	705421	6S60	60"	50

	ID	MODEL#	SIZE	CTN
	ORDER#			QTY
	705424	8D8	8"	250
	705425	8D10	10"	250
	705426	8D60	60"	50

	ID	MODEL#	SIZE	CTN
	ORDER#			QTY
	709521	364	4"	1
	709523	366	6"	1
	709525	368	8"	1

	ID	MODEL#	SIZE	CTN
	ORDER#			QTY
	709514	394	4"	1
	709516	396	6"	1
	709518	398	8"	1

	ID	MODEL#	SIZE	CTN
	ORDER#			QTY
	709986	49P1436	14" x 36"	1
	709987	49P1636	16" x 36"	1
	709988	49P1836	18" x 36"	1
	709989	49P2036	20" x 36"	1
	709990	49P2236	22" x 36"	1
	709991	49P2436	24" x 36"	1

	ID	MODEL#	SIZE	CTN
	ORDER#			QTY
	710021	49T2020	20" x 20"	1
	710023	49T2424	24" x 24"	1

	ID	MODEL#	SIZE	CTN
	ORDER#			QTY
	709071	63AFG6	6"	12
	709073	63AFG8	8"	12

	ID	MODEL#	SIZE	CTN
	ORDER#			QTY
	708994	84ST6	6"	25
	708996	84ST8	8"	25
	708998	84ST10	10"	12

	ID	MODEL#	SIZE	CTN
	ORDER#			QTY
	705420	966	6"	12

	ID	MODEL#	SIZE	CTN
	ORDER#			QTY
	709434	996	6"	1
	709436	998	8"	1

	ID	MODEL#	SIZE	CTN
	ORDER#			QTY
	705206	810	20" x 10" - 20" x 16"	1
	705207	811	25" x 10" - 25" x 16"	1

	ID	MODEL#	SIZE	CTN
	ORDER#			QTY
	776858	B68G48H	13-1/2" x 20" x 48"	1
	710562	B72G48H	16" x 20" x 48"	1
	776857	B80G48H	20" x 20" x 48"	1

	ID	MODEL#	SIZE	CTN
	ORDER#			QTY
	709633	110696	96"	10

	ID	MODEL#	SIZE	CTN
	ORDER#			QTY
	705343	HT1576	7" x 6"	12

	ID	MODEL#	SIZE	CTN
	ORDER#			QTY
	708713	PH54106	4" x 10" x 6"	12
	708717	PH544106	4" x 10" x 6"	12
	705339	PH56106	6" x 10" x 6"	12

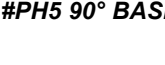
	ID	MODEL#	SIZE	CTN
	ORDER#			QTY
	708717	PH544106	4" x 10" x 6"	12







FOR ADDITIONAL INFORMATION, VISIT THE SOUTHWARK WEBSITE AT www.southwarkmetal.com

SOUTHWARK

PREFAB SHEET METAL DUCT & FITTINGS

GALVANIZED WALLSTACK



	ID ORDER#	MODEL#	SIZE	CTN QTY
WALLSTACK				
	708325	WSJ24212	2-1/4" x 12" x 24"	10
	708327	WSJ24310	3-1/4" x 10" x 24"	10
	708328	WSJ24312	3-1/4" x 12" x 24"	10
#WS10X STACKHEADS WITH EARS				
	708414	WS10X3106	3-1/4" x 10" - 6" x 10"	12
#WS13 45° FLAT STACK ANGLES				
	708359	WS13212	2-1/4" x 12"	1
	708361	WS13310	3-1/4" x 10"	1
	708362	WS13312	3-1/4" x 12"	1
#WS14 90° FLAT RADIUS ELBOWS				
	708365	WS14212	2-1/4" x 12"	1
	708368	WS14312	3-1/4" x 12"	1
#WS15 45° VERTICAL SHORTWAY STACK ANGLES				
	708353	WS15212	2-1/4" x 12"	1
	708355	WS15310	3-1/4" x 10"	1
	708356	WS15312	3-1/4" x 12"	1
#WS16 90° VERTICAL SHORTWAY ELBOWS				
	708346	WS16210	2-1/4" x 10"	12
	708347	WS16212	2-1/4" x 12"	12
	708349	WS16310	3-1/4" x 10"	12

FOR ADDITIONAL INFORMATION, VISIT THE SOUTHWARK WEBSITE AT www.southwarkmetal.com

SOUTHWARK

PREFAB SHEET METAL DUCT & FITTINGS

GALVANIZED OVAL



	ID	MODEL#	SIZE	CTN
	ORDER#			QTY
	708455	1606	6" x 60"	10
	705213	1006	6" x 100"	6
	705214	1007	7" x 100"	6
	740823	1008	8" x 100"	6

#106 OVAL TO ROUND REVERSE BOOTS

	705227	1066	6"	12
	705228	1067	7"	12
	708500	1068	8"	12

#106NC OVAL TO ROUND REVERSE BOOTS—NO CRIMP

705229	1066NC	6"	12
--------	--------	----	----

#110 OVAL STACKHEADS

	705215	1101066	10" x 6" x 6"	12
	708467	1101268	12" x 6" x 8"	12

#114 90° FLAT OVAL ELBOWS

	705221	1146	6"	12
	705222	1147	7"	12
	708482	1148	8"	12

#115 45° VERTICAL SHORTWAY OVAL ANGLES

	705223	1156	6"	12
	708488	1158	8"	12

#115NC 45° VERTICAL SHORTWAY OVAL ANGLES—NO CRIMP

708490	1156NC	6"	12
--------	--------	----	----

#116 90° VERTICAL SHORTWAY OVAL ELBOWS

	705225	1166	6"	12
	705226	1167	7"	12
	708494	1168	8"	12

#124 OVAL TO ROUND 90° BOOTS

	705231	1246	6"	12
	705232	1247	7"	12
	708506	1248	8"	12

#124NC OVAL TO ROUND 90° BOOTS—NO CRIMP

705233	1246NC	6"	12
--------	--------	----	----

#124R 90° OVAL REGISTER BOOTS

	708532	124R4106	4" x 10" - 6"	12
--	--------	----------	---------------	----

#127 OVAL TO ROUND STRAIGHT BOOTS

	705235	1276	6"	12
	708517	1277	7"	12
	708518	1278	8"	12

#127NC OVAL TO ROUND STRAIGHT BOOTS—NO CRIMP

705236	1276NC	6"	12
--------	--------	----	----

#127R STRAIGHT OVAL REGISTER BOOTS

	708541	127R4106	4" x 10" - 6"	12
--	--------	----------	---------------	----

#128R END OVAL REGISTER BOOTS



	708552	128R4126	4" x 12" - 6"	12
--	--------	----------	---------------	----

#355 STRAIGHT OVAL REGISTER BOXES

	705237	3552126	2-1/4" x 12" - 6"	12
	705238	3554106	4" x 10" - 6"	12

FOR ADDITIONAL INFORMATION, VISIT THE SOUTHWARK WEBSITE AT www.southwarkmetal.com

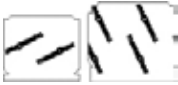

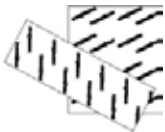
	ID ORDER#	MODEL#	SIZE	DESCRIPTION
	121285	16348	16"	PANNING CONNECTOR , box of 25
	121286	19348	19-1/2"	<i>Same as above</i>
	121287	32336	32"	<i>Same as above</i>
	712958	41118	1-1/2"	SNAP CLAMP LINESET MOUNTING BRACKET , 1-1/2" OD, for residential applications, bag of 10
	756169	41125	2"	<i>Same as above</i> , but 2" OD and bag of 5
	769333	41150	3"	<i>Same as above</i> , but 3" OD and bag of 5
	73304	16013	16" x 12"	STANDARD JOIST HEADER , <u>fire resistant</u> , for tight sealing air blocks, pre-cut and scored, box of 25
	215615	16018	16" x 17"	<i>Same as above</i> , but for I-joists
	89091	24631	30" x 6"	RETURN AIR GRILLE FRAME , windowed, transparent film to allow light through but stop dust or dirt, can be broken in half to form two 14" x 6" frames, designed to fit Hart & Cooley grilles, package of 10
	711787	14630	30" x 6"	<i>Same as above</i> , but designed to fit standard grilles
	73300	16048	16" x 47-1/2"	RETURN AIR PANNING , consists of corrugated insulation faced with aluminum, box of 25
	73301	19048	19-1/2" x 47-1/2"	<i>Same as above</i>
	73302	32036	32" x 35-1/2"	<i>Same as above</i>

FOR ADDITIONAL INFORMATION, VISIT THE
THERMO MANUFACTURING INC. WEBSITE AT www.thermopan.com

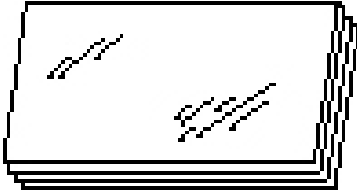

ID ORDER#	GAUGE	FINISH	SIZE
788	28 GAUGE	◆	36" x 96"
790	26 GAUGE	G60	36" x 96"
796	24 GAUGE	G60	36" x 96"
794	26 GAUGE	G60	48" x 96"
39509	24 GAUGE	G60	48" x 96"
52725	26 GAUGE	G60	48" x 120"
29894	24 GAUGE	G60	48" x 120"
29895	22 GAUGE	G60	48" x 120"
49760	20 GAUGE	G60	48" x 120"
49759	18 GAUGE	G60	48" x 120"
49758	16 GAUGE	G60	48" x 120"

DISCOUNTS: Gauges and sizes may be combined for quantity discounts. We offer a **10% discount on quantities of 12-49** and a **15% discount on quantities of 50+**. For skid pricing, please call our office or contact your sales representative.

NOTE: We buy prime sheets. However, weight per sheet can vary with each order. For heavier gauges (24-14), make arrangements to have help for the Townsend driver when unloading.

◆: May be provided in a mix of finishes.

DURODYNE

DUCT WORK ACCESSORIES



ID ORDER#	MODEL#	SKU#	DESCRIPTION
ADHESIVES & SEALERS			
193686	CCASA-WFT	5164	ADHESIVE—INSULATION (AEROSOL) , fast tack, 12 oz. can, carb compliant
77766	WIT1HS	5170	ADHESIVE—INSULATION , 1 gallon, for bonding insulation material to sheet metal, water base, fast tack, non-flammable
177663	SAS-UL1	5027	DUCT SEALER , 1 gallon, water-based, indoor/outdoor, paintable, remains flexible, grey in color and dries grey
138000	SAS-ULC	5029	<i>Same as above</i> , but 10.5 oz.
655117	SSA-C	5112	SEALANT—SILICONE , 9.5 oz., aluminum gray color (=Boss #37003)
85328	SSC-C	5111	<i>Same as above</i> , but clear color (=Boss #31200)
DAMPERS & REGULATORS			
77726	KSR195	8045	DIAL REGULATOR , 3/8", suitable to use on round as well as square duct, clear markings on the regulator indicate damper position which can be locked securely by a wing nut, consists of : (1) KR-3 regulator, (1) KP-7 spring end bearing and (1) KP-9S square end bearing
77735	QJDE	6239	JIFFY DAMPER , 6", solid rapid with handle (=JDE6H)
77733	JDS7	8095	<i>Same as above</i> , but 7" round and double bearing
77734	JDS8	8096	<i>Same as above</i> , but 8"
77717	RS156	8086	"RAPIT" DAMPER REGULATOR , rust resistant, heavy gauge, galvanized steel, threaded to accept a 5/16-18 wing nut handle, consists of: (1) RB-50 "RAPIT" spring bearing, (1) RP-3 washer, (1) RP-1 handle & (1) RP-2 wing nut, package of 10 sets
77716	RS256	8085	<i>Same as above</i> , but consists of (2) RB-50 "RAPIT" spring bearings, (1) RP-3 washer, (1) RP-1 handle & (1) RP-2 wing nut, package of 10 sets
DUCT CONNECTORS			
77709	JBX-100	10169	CONNECTOR—JUNIOR , 28 gauge galvanized, black Excelon, woven nylon/polyester blend with vinyl coating, 100' roll, "Guard Loc" seam, 1-3/4" metal — 3" fabric — 1-3/4" metal
77702	MBX333	10159	CONNECTOR—METALFAB DUCT , 24 gauge galvanized, black Excelon, woven nylon/polyester blend with vinyl coating, 100' roll, "Grip Loc" seam, 3" metal — 3" fabric — 3" metal
193685	SFMBX333	10379	<i>Same as above</i> , but single fold
209917	FTC34	26073	ECONO-POINT PINS , for pinspotters, for 1" duct liner, box of 5000

FOR ADDITIONAL HAND TOOLS AND FASTENERS, SEE THE 700 SECTION

FOR ADDITIONAL INFORMATION, SEE THE DURODYNE WEBSITE AT www.durodyne.com

DURODYNE

DUCT WORK ACCESSORIES



ID ORDER#	MODEL#	SKU#	DESCRIPTION
INSULATION ACCESSORIES			
77782	BGT12	26033	BANGER FASTENER , for 1/2" - 2 lb. insulation, package of <u>1000</u>
77783	BGT100	26044	<i>Same as above</i> , but for 1" - 1-1/2 lb. insulation
77785	BGB12	26095	<i>Same as above</i> , but for 1/2" - 2 lb. insulation and package of <u>5000</u>
77786	BGB100	26096	<i>Same as above</i> , but for 1" - 1-1/2 lb. insulation
623548	SAH34	26067	DYNASTICK INSULATION HANGER , 3/4", self-adhesive, package of <u>100</u>
77772	SAH114	26068	<i>Same as above</i> , but 1-1/4"
77773	SAH134	26069	<i>Same as above</i> , but 1-1/4"
77776	SAHB114	26037	<i>Same as above</i> , but 1-1/4" and package of <u>500</u>
77777	SAHB134	26040	<i>Same as above</i> , but 1-3/4"
77771	FSG250	26055	FLIPSTIX INSULATION HANGERS , 1" x 4", accommodates all insulation thicknesses, up to and including 2", 24 gauge galvanized steel, package of 100
161992	PN114	26002	SPOTTER PINS , 1-1/4" for 1" duct liner, package of 1,000
PIN RIVETS			
77756	SS42DT	23002	PIN RIVET—STEEL RIVET & PIN , 1/8" rivet diameter, 1/8" maximum grip, dome head style, 1000/box
77757	SS44DT	23004	<i>Same as above</i> , but 1/4" maximum grip
77760	AA42DT	23060	PIN RIVET—ALUMINUM RIVET & PIN , 1/8" rivet diameter, 1/8" maximum grip, dome head style, 1000/box
77761	AA44DT	23062	<i>Same as above</i> , but 1/4" maximum grip
STARTING COLLARS			
757712	101105	101105	STARTING COLLAR—DYN-O-RING , 10", for galvanized spiral duct, 18 gauge, 90 degree, 2-1/2" x 1-1/2"
757713	101107	101107	<i>Same as above</i> , but 12"
757714	101109	101109	<i>Same as above</i> , but 14"
757715	101111	101111	<i>Same as above</i> , but 16"
757716	101113	101113	<i>Same as above</i> , but 18"
TOOLS			
77715	SSES	10015	EDGE SCRIBE , stainless steel, magnetic, marks 1/8", 3/16", 1/4", 5/16", 3/8", 1/2", 5/8", 3/4" and 1"
MISCELLANEOUS			
58367	DADC12X12	6134	ACCESS DOOR—INSULATED , 12" x 12", galvanized (=IADC)
77765	QR2	36050	QUIETURN STEEL SIDE RAIL , 24 gauge, 100' roll
77712	VR2	4002	VANE RAIL , continuous coil, 100' roll
172345	HDW9512	10064	WIPES—HEAVY DUTY , 70 per pkg.

FOR ADDITIONAL INFORMATION, SEE THE DURODYNE WEBSITE AT www.durodyne.com

DURODYNE

DYNA-TITE & DYN-O-MATE DUCT WORK ACCESSORIES



ID ORDER#	MODEL#	SKU#	DESCRIPTION
--------------	--------	------	-------------

DYNA-TITE TOOLS & ACCESSORIES

568930	CL12-WC3	03114	CABLE LOCK , for 3/32" wire rope, 10/box
568929	CL23-WC6	03118	<i>Same as above</i> , but for 1/8" and 3/16" wire rope
699481	DSB1	30340	SPIRAL BUCKLE , 50/box
568931	WC3-CL12	30202	WIRE ROPE , 3/32", 500'/roll
568932	WC4-CL18	30204	<i>Same as above</i> , but 1/8"
714115	WC6-CL23	30206	<i>Same as above</i> , but 3/16" and 250'/roll
699482	ZCWR05	30041	ZIP-CLIP , 10 bags/carton



DYN-O-MATE COMMERCIAL TOOLS & ACCESSORIES

466082	BTL500	21042	BUTYL GASKET , 25'
699248	DOMQCLT	13096	CLEAT—UNIVERSAL QUAD , 6"
719890	KVFDM12-WC3	31075	DUCT HANGING BRACKET WITH CABLE LOCK , for 3/32" wire rope, 10/box
771767	101103	--	DYN-O-RING COLLAR , 8", 18 gauge, 2-1/2" x 1-1/2'
466075	DOMJ20	21230	"J" FLANGE , 20'
466130	DOMNB38	21060	NUTS & BOLTS , 3/8", 125/bag
699247	DDJSNB	21095	SPEED CORNER , for "J" flange
568318	SS2410	13214	STANDING S-LOCK , 1" x 10', 24 gauge
692775	DOMC	21254	TDC CORNER
618172	DOMF	21255	TDF CORNER
466131	HTV2-2610	13203	TURNING VANE , 2" x 10', 26 gauge
466084	HTV4-2410	13207	TURNING VANE , 4" x 10', 24 gauge
466133	DHVR2-2210	13300	VANE RAIL , 4" x 10', 22 gauge
466086	DHVR4-2210	13302	<i>Same as above</i> , but 4" x 10'

FOR ADDITIONAL INFORMATION, SEE THE DURODYNE WEBSITE AT www.durodyne.com

HARDCAST INDOOR SOLVENT



	ID ORDER#	MODEL#	DESCRIPTION
	707134	302014	SG-404 SURE-GRIP SEALANT CARTRIDGE—FIBER FREE , solvent-based rubber duct sealant, gray, <u>11 ounces</u> , 25/ctn
	716711	302009	Same as above, but <u>1 gallon</u> and 4/ctn
	710683	304156	DS-321 DUCT SEAL—FIBER REINFORCED , industrial grade sealant for all types of metal duct, glass fiber duct board, flex duct, duct fabric and flexible tubing runout; non-toxic, water-based, solvent-free, gray, UL 181 B-M listed, <u>1 gallon</u> , 4/ctn
	710684	308142	FWB-75 FLATHEAD WELD PINS , 3/4", for ductliner, carbon alloy steel with zinc plated surface finish, 0.7" grip length, 32°F to 250°F temperature rating, 5000/box

FOR ADDITIONAL INFORMATION, SEE THE HARDCAST WEBSITE AT www.carlislehvac.com

ATCO FLEX-DUCT INSULATION PRODUCTS



ID ORDER#	MODEL#	SIZE	DESCRIPTION
188588	UPC-076RF	4" x 25'	INSULATED FLEX DUCT - CLASS, 1, 6.0 R value , fiberglass with interior wire and polyester inner core, scrim reinforced polyester exterior, UL #181 and NFPA 90A and 90B listed, 5000 FPM (†)
188589		6" x 25'	Same as above
188590		7" x 25'	Same as above
188591		8" x 25'	Same as above
188592		10" x 25'	Same as above
188593		12" x 25'	Same as above
188594		14" x 25'	Same as above
188595		16" x 25'	Same as above
188596		18" x 25'	Same as above
619153	UPC-078RF	4" x 25'	INSULATED FLEX DUCT-CLASS 1, 8.0 R value , fiberglass with interior wire and polyester inner core, scrim reinforced polyester exterior, UL #181 and NFPA 90A and 90B listed, 5000 FPM (†)
619156		6" x 25'	Same as above
619158		7" x 25'	Same as above
619159		8" x 25'	Same as above
619160		10" x 25'	Same as above
619161		10" x 25'	Same as above
619162		12" x 25'	Same as above
619163		14" x 25'	Same as above
619164		16" x 25'	Same as above
38305	UPC-050	4" x 25'	UNINSULATED FOIL FLEX DUCT , Class 1 connector, constructed of a triple lamination of metalized polyester, aluminum foil & polyester film around an interior core; UL #181; 5000 FPM
45641		6" x 25'	Same as above
54127		7" x 25'	Same as above
713878		8" x 25'	Same as above
668880	UPC-010RF	4" x 5'	FIBERGLASS SLEEVE INSULATION, 8.0 R value , vinyl clad, 1" thick, designed for indoor use only and for HVAC systems not exceeding 250°F operating temperatures, silver color (††)
668881		6" x 5'	Same as above
668882		7" x 5'	Same as above
668883		8" x 5'	Same as above
668884		10" x 5'	Same as above
668885		12" x 5'	Same as above
668998 *		14" x 5'	Same as above

* = SPECIAL ORDER ITEM

FOR ADDITIONAL INFORMATION, VISIT THE ATCO WEBSITE AT www.atcoflex.com

ID ORDER#	MODEL#	SIZE	DESCRIPTION	* = SPECIAL ORDER ITEM
-----------	--------	------	-------------	------------------------

JOHNS MANVILLE (JM) LINE #5520

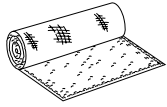

600768	90015277 (T-75)	1-1/2" x 48" x 100'	FIBERGLASS DUCT WRAP—MICROLITE EQ 3/4# , features "Foil-Skrim-Kraft" (FSK) facing and 2" stapling or taping edge; .75 PCF density and R-value of 4.2
674236	90015280 (T-75)	3" x 48" x 50'	Same as above, but 3" and 50' and R-value of 8.3
600771	90005551	1/2" x 47" x 100'	FIBERGLASS DUCT LINER—LINACOUSTIC RC 2# , 1/2" flexible black fiberglass blanket with bonded mat on one side and edge coated, used as a thermal-acoustical liner for metal duct, 2.0 PCF density
600773	90005510	1" x 47" x 100'	Same as above, but 1" thick, RC 1.5#
600774	90005531	1" x 59" x 100'	Same as above, but 1" thick x 59" width, RC 1.5#
600767	90005696 (475)	1" x 48" x 10'	DUCT BOARD—MICRO-AIRE #475 , foil faced with fiberglass on air side, special mat reduces bacteria and mold growth, manufactured from resin-bonded fiberglass, formed into a rigid, rectangular board faced on one side with FSK vapor retarder, air stream impregnated with polymer coating, made with shiplap edge; rated for temperatures up to 250°F, maximum air velocity of 5000 fpm and 2" w.c., "R" of 4.3, sold by carton of 6 only

FOR ADDITIONAL INFORMATION, VISIT THE JOHNS MANVILLE WEBSITE AT www.jm.com

AMERICAN WARMING LINE #5940

10753	LINKA165	--	FIRE DAMPER FUSIBLE LINK WITH EYELET , 165°F
10754	LINKA212	--	Same as above, but 212°F

SELKIRK

“RV” ROUND GAS VENT PIPE & FITTINGS



	ID ORDER#	MODEL#	SIZE	CTN QTY
RV PIPE				
6" length	6383	3RV-6	3"	6
	6385	4RV-6	4"	6
	6386	5RV-6	5"	6
	6387	6RV-6	6"	6
	6388	7RV-6	7"	4
	6390	8RV-6	8"	4
12" length	6402	3RV-12	3"	6
	6403	4RV-12	4"	6
	6404	5RV-12	5"	6
	6405	6RV-12	6"	6
	6406	7RV-12	7"	4
	6407	8RV-12	8"	4
Adjust. 12" length	6394	3RV-AJ12	3"	6
	6397	4RV-AJ12	4"	6
	6398	5RV-AJ12	5"	6
	6399	6RV-AJ12	6"	6
	6400	7RV-AJ12	7"	4
	6401	8RV-AJ12	8"	4
18" length	6408	3RV-18	3"	6
	6409	4RV-18	4"	6
	6410	5RV-18	5"	6
	6411	6RV-18	6"	6
	6412	7RV-18	7"	4
	6413	8RV-18	8"	4
24" length	6416	3RV-2	3"	6
	6417	4RV-2	4"	6
	6419	5RV-2	5"	6
	6420	6RV-2	6"	6
	6421	7RV-2	7"	4
	6422	8RV-2	8"	4
3 ft. length	6423	3RV-3	3"	6
	6424	4RV-3	4"	6
	6425	5RV-3	5"	6
	6426	6RV-3	6"	6
	6427	7RV-3	7"	4
	6428	8RV-3	8"	4
4 ft. length	48600	3RV-4	3"	6
	48606	4RV-4	4"	6
	48607	5RV-4	5"	6
	48608	6RV-4	6"	6
	48609	7RV-4	7"	4
5 ft. length	6429	3RV-5	3"	6
	6430	4RV-5	4"	6
	6431	5RV-5	5"	6
	6432	6RV-5	6"	4
	6433	7RV-5	7"	4
	6434	8RV-5	8"	4



RV TOP (Bird Proof)

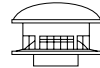

ID ORDER#	MODEL#	SIZE	CTN QTY
6435	3RV-RT	3"	6
6436	4RV-RT	4"	6
6437	5RV-RT	5"	6
6438	6RV-RT	6"	6
6439	7RV-RT	7"	4
6440	8RV-RT	8"	4

RV FLASHINGS (0 to 6/12 pitch)

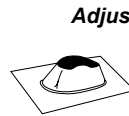

Adjustable

ID ORDER#	MODEL#	SIZE	CTN QTY
6441	3RV-AF	3"	6
6442	4RV-AF	4"	6
6443	5RV-AF	5"	6
6444	6RV-AF	6"	6
6445	7RV-AF	7"	4
6446	8RV-AF	8"	4

Adjustable tall cone

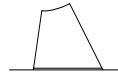

ID ORDER#	MODEL#	SIZE	CTN QTY
6447	3RV-TFA	3"	6
6448	4RV-TFA	4"	6
6449	5RV-TFA	5"	6
6450	6RV-TFA	6"	6
6451	7RV-TFA	7"	4
6452	8RV-TFA	8"	4

RV FLASHINGS (6/12 to 12/12 pitch)



Adjustable

ID ORDER#	MODEL#	SIZE	CTN QTY
48565	3RV-AF12	3"	6
48566	4RV-AF12	4"	6
48567	5RV-AF12	5"	6
48568	6RV-AF12	6"	6

RV STORM COLLAR



ID ORDER#	MODEL#	SIZE	CTN QTY
6456	3RV-SC	3"	6
6457	4RV-SC	4"	6
6458	5RV-SC	5"	6
6459	6RV-SC	6"	6
6460	7RV-SC	7"	4
6462	8RV-SC	8"	4

RV CEILING (PIPE) COLLAR



ID ORDER#	MODEL#	SIZE	CTN QTY
6463	3RV-GC	3"	6
6464	4RV-GC	4"	6
6465	5RV-GC	5"	6
6466	6RV-GC	6"	6
6467	7RV-GC	7"	6

**FOR ADDITIONAL INFORMATION,
VISIT THE SELKIRK WEBSITE AT
www.selkirkcorp.com**

SELKIRK

“RV” ROUND GAS VENT FITTINGS



ID	MODEL#	SIZE	CTN
ORDER#			QTY

RV DRAFT HOOD CONNECTOR



6468	3RV-DH	3"	6
6469	4RV-DH	4"	6
6470	5RV-DH	5"	6
6472	6RV-DH	6"	6
6474 *	7RV-DH	7"	4
6476	8RV-DH	8"	4

RV TEES

Straight

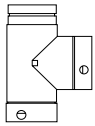

6478	3RV-TS	3"	6
6480	4RV-TS	4"	6
6481	5RV-TS	5"	6
6487	6RV-TS	6"	6
6489	7RV-TS	7"	4
6491	8RV-TS	8"	4

Reducing

6493	4RV-T3	4" to 3"	6
6498	6RV-T3	6" to 3"	6

RV TEE CAP

6502	3RV-TC	3"	6
6504	4RV-TC	4"	6
6506	5RV-TC	5"	6
6507	6RV-TC	6"	6
6509	7RV-TC	7"	4
6512	8RV-TC	8"	4

RV ADJUSTABLE 90° ELBOW



6514	3RV-90	3"	6
6517	4RV-90	4"	6
6519	5RV-90	5"	6
6522	6RV-90	6"	6
6523	7RV-90	7"	4
6525	8RV-90	8"	4

RV ADJUSTABLE 45°/60° ELBOW

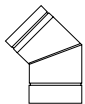

187387	3RV-45	3"	6
187388	4RV-45	4"	6
187389	5RV-45	5"	6
187390	6RV-45	6"	6

RV ADJUSTABLE 45° ELBOW

6538	7RV-EL45	7"	4
6539	8RV-EL45	8"	4

RV INCREASERS

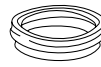

ID	MODEL#	SIZE	CTN
ORDER#			QTY

6542	3RV-I4	3" x 4"	6
6544	3RV-I5	3" x 5"	6
6545	4RV-I5	4" x 5"	6
6546	4RV-I6	4" x 6"	6
6547	5RV-I6	5" x 6"	6
6551	6RV-I7	6" x 7"	4
6552	6RV-I8	6" x 8"	4

RV WALL THIMBLE



6555	3RV-WT	3"	6
6557	4RV-WT	4"	6
6559	5RV-WT	5"	6
6560	6RV-WT	6"	6

RV GAS VENT SUPPORT

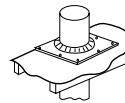

6782	3RV-FSP	3"	10
6784	4RV-FSP	4"	10
6785	5RV-FSP	5"	10
6786	6RV-FSP	6"	10

* = SPECIAL ORDER ITEM

**FOR ADDITIONAL INFORMATION,
VISIT THE SELKIRK WEBSITE AT
www.selkirkcorp.com**

SELKIRK

“OV” OVAL GAS VENT PIPE & FITTINGS

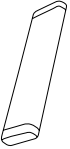

	ID ORDER#	MODEL#	SIZE	CTN QTY
OVAL PIPE				
	624996	4OV-6	4" x 6"	6
	624997	4OV-12	4" x 12"	6
	624998	4OV-18	4" x 18"	6
	624999	4OV-24	4" x 24"	6
	625000	4OV-36	4" x 36"	6
	625002	4OV-48	4" x 48"	6
	625003	4OV-60	4" x 60"	6

	ID ORDER#	MODEL#	SIZE	CTN QTY
OVAL RAIN CAP				
	625009	4OV-OT	4"	12

	ID ORDER#	MODEL#	SIZE	CTN QTY
ADJ. OVAL FLASHING (FLAT TO 5/12 PITCH)				
	625018	4OV-AF	4"	12

	ID ORDER#	MODEL#	SIZE	CTN QTY
OVAL STORM COLLAR				
	625020	4OV-SC	4"	12

	ID ORDER#	MODEL#	SIZE	CTN QTY
OVAL TEE CAP				
	625006	4OV-TC	4"	1

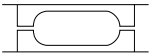
	ID ORDER#	MODEL#	SIZE	CTN QTY
OVAL FIRESTOP SPACER (FOR 2 x 4 WALL)				
	625012	4OV-FS	4"	6

	ID ORDER#	MODEL#	SIZE	CTN QTY
OVAL STANDARD TEE (Tee branch accepts either double- or single-wall pipe)				
	625005	4OV-TS	4"	6

	ID ORDER#	MODEL#	SIZE	CTN QTY
OVAL 45° ELBOWS (STANDARD)				
	625007	4OV-45S	4"	6

	ID ORDER#	MODEL#	SIZE	CTN QTY
OVAL 45° ELBOWS (FLAT)				
	625008	4OV-45F	4"	6

	ID ORDER#	MODEL#	SIZE	CTN QTY	
OVAL ADAPTERS					
4" RV round -WV oval	625021	4RV-OV4	4"	6	
	4" WV oval - RV round	625022	4OV-RV4	4"	6



NOTE: Selkirk Model OV gas wall vent is listed to UL441 as a type BW gas vent for NG or LP double wall. Construction features an aluminum inner liner (4" @ 0.012" thickness) and outer pipe (4" @ 0.018" thickness) and snap-lock joints

**FOR ADDITIONAL INFORMATION,
VISIT THE SELKIRK WEBSITE AT
www.selkirkcorp.com**

SELKIRK

“R” ROUND GAS VENT PIPE & FITTINGS



	ID	MODEL#	SIZE	CTN	QTY
	ORDER#				
R PIPE					
	18" length	711053	10R18-S	10"	2
		711011	12R18-S	12"	2
		711081	14R18-S	14"	1
	36" length	711051	10R3-S	10"	2
		710667	12R3-S	12"	2
		711079	14R3-S	14"	1

	ID	MODEL#	SIZE	CTN	QTY
	ORDER#				
R UNIVERSAL RAIN CAP					
		711061	10C-S	10"	2
		710668	12C-S	12"	2
		711088	14C-S	14"	1

	ID	MODEL#	SIZE	CTN	QTY
	ORDER#				
R ADJ. FLASHINGS (0 to 6/12 pitch)					
		710669	10RF-S	10"	6
		711019	12RF-S	12"	6
		711089	14RF-S	14"	1

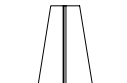
	ID	MODEL#	SIZE	CTN	QTY
	ORDER#				
R TALL CONE FLASHINGS, FLAT					
		711062	10RFT-S	10"	6
		711020	12RFT-S	12"	1
		710670	14RFT-S	14"	1

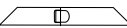
	ID	MODEL#	SIZE	CTN	QTY
	ORDER#				
R STORM COLLAR					
		711063	10RSC-S	10"	6
		710671	12RSC-S	12"	6
		711003	14RSC-S	14"	1

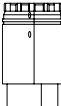
	ID	MODEL#	SIZE	CTN	QTY
	ORDER#				
R DRAFT HOOD CONNECTOR					
		711059	10RDC-S	10"	2
		711017	12RDC-S	12"	2

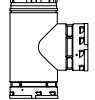
	ID	MODEL#	SIZE	CTN	QTY
	ORDER#				
R TEES, STRAIGHT					
		711057	10RT-S	10"	2
		711015	12RT-S	12"	2
		711085	14RT-S	14"	1

	ID	MODEL#	SIZE	CTN	QTY
	ORDER#				
R TEE CAP					
		711058	10RTC-S	10"	1
		711016	12RTC-S	12"	1

	ID	MODEL#	SIZE	CTN	QTY
	ORDER#				
R 45° ELBOW					
		711056	10R45-S	10"	2
		711014	12R45-S	12"	2

	ID	MODEL#	SIZE	CTN	QTY
	ORDER#				
R SUPPORT BRACKET ASSEMBLY (for 10" pipe)					
		711065	8HS-SBA-S	8"	1

	ID	MODEL#	SIZE	CTN	QTY
	ORDER#				
R SUPPORT PLATE					
		711067	10RSP-S	10"	1
		711028	12RSP-S	12"	1
		711090	12SP-S	14"	1

	ID	MODEL#	SIZE	CTN	QTY
	ORDER#				
R INCREASER					
		711018	10RX12-S	10-12"	1









**FOR ADDITIONAL INFORMATION,
VISIT THE SELKIRK WEBSITE AT
www.selkirkcorp.com**

SELKIRK

ULTRA-TEMP ALL FUELS CHIMNEY PIPE & FITTINGS



- Class "A" HT insulated pipe
- Stainless steel inner and outer jacket
- UL 103 listed
- Compatible with old-style SSII chimney







	ID ORDER#	MODEL#	DESCRIPTION	CTN QTY
	39197	6T-AIS	ATTIC INSULATION SHIELD, 6"	1
	39198	8T-AIS	Same as above, but 8"	1
	39182	6UT-18	CHIMNEY LENGTH, 6" x 18" , stainless steel, includes (1) locking band	1
	39181	6UT-36	Same as above, but 6" x 36"	1
	39184	8UT-18	CHIMNEY LENGTH, 8" x 18" , stainless steel, includes (1) locking band	1
	39183	8UT-36	Same as above, but 8" x 36"	1
	229032	6T-EL15KIT	ELBOW KIT, 6" - 15° , consists of (2) 15° elbows, includes (1) support bracket and (2) locking bands	1
	229033	8T-EL15KIT	Same as above, but 8"	1
	39193	6T-FSP	FINISH SUPPORT PACKAGE, 6" , square plate	1
	39194	8T-FSP	Same as above, but 8"	1
	39205	6T-TF	FLASHING—TALL CONE (FLAT), 6" , 0/12-2/12	4
	39206	8T-TF	Same as above, but 8"	4
	39207	6T-AF6	FLASHING—ADJUSTABLE, 6" , 2/12-6/12	4
	39208	8T-AF6	Same as above, but 8"	4
	39209	6T-AF12	FLASHING—ADJUSTABLE, 6" , 6/12-12/12	1
	39210	8T-AF12	Same as above, but 8"	1
	39199	6T-LB	LOCKING BAND, 6"	4
	39200	8T-LB	Same as above, but 8"	4
	444201	6T-PCPAJ	PITCHED CEILING PLATE, 6" , 0/12 - 2/12	1
	444202	8T-PCPAJ	Same as above, but 8"	1
	197593	6T-RBK	ROOF BRACE KIT, 6"	1
	142134	8T-RBK	Same as above, but 8"	1

FOR ADDITIONAL INFORMATION, VISIT THE SELKIRK WEBSITE AT www.selkirkcorp.com

ULTRA-TEMP HT ALL FUELS CHIMNEY
CLASS "A" INSULATED FITTINGS

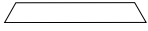

- Class "A" HT insulated pipe
- Stainless steel inner and outer jacket
- UL 103 listed
- Compatible with old-style SSII chimney

ID ORDER#	MODEL#	DESCRIPTION	CTN QTY
 10823	RSK	ROOF BRACKET SUPPORT KIT , includes adjustable bracket and perforated strap	1
 39201	6T-CT	ROOF CAP , 6", round top	1
39202	8T-CT	Same as above, but 8"	1
 43224	6T-DSAC	SMOKE PIPE ADAPTER , 6", with stainless steel coupler	4
43225	8T-DSAC	Same as above, but 8"	4
 39203	5/6T-SC	STORM COLLAR , fits 5" and 6", adjustable	4
39204	7/8T-SC	Same as above, but fits 7" and 8"	4
 42604	6T-SB	SUPPORT BOX , 6"	1
42606	8T-SB	Same as above, but 8"	1
 39189	6T-IT	TEE—INSULATED , 6", stainless steel, with cap and (1) locking band	1
39190	8T-IT	Same as above, but 8"	1
 39191	6T-WSK	WALL SUPPORT KIT , 6"	1
39192	8T-WSK	Same as above, but 8"	1

FOR ADDITIONAL INFORMATION, VISIT
THE SELKIRK WEBSITE AT www.selkirkcorp.com

SELKIRK GAS LINER SYSTEM



ID ORDER#	MODEL#	SIZE	DESCRIPTION	* = SPECIAL ORDER ITEM
--------------	--------	------	-------------	------------------------

NOTE: Model AFCL is not designed to pass through a combustible area such as a ceiling, attic wall, floor roof joist or crawl space.

ALUMINUM FLEX CHIMNEY LINER KITS

578393	AF25-03	3" x 25'	MODEL AFCL 2-PLY ALUMINUM FLEXIBLE CHIMNEY LINER KIT , for venting all types of Category I gas appliances (furnaces, boilers, water heaters, and fireplace inserts or stoves); includes flex liner, round top flashing with 3" collar, mortar guard and hardware; limited lifetime warranty, UL listed, 1/ctn
578394	AF35-03	3" x 35'	<i>Same as above</i>
578396	AF25-04	4" x 25'	<i>Same as above</i>
578395	AF35-04	4" x 35'	<i>Same as above</i>
578397	AF25-05	5" x 25'	<i>Same as above</i>
578398	AF35-05	5" x 35'	<i>Same as above</i>
578399	AF25-06	6" x 25'	<i>Same as above</i>
578400	AF35-06	6" x 35'	<i>Same as above</i>

EXTENSION KITS

578403 *	AFE10-03	3" x 10'	2-PLY ALUMINUM CHIMNEY LINER , 10' length with flex connector, UL listed, 1/ctn
578404 *	AFE10-04	4" x 10'	<i>Same as above</i>
578405 *	AFE10-05	5" x 10'	<i>Same as above</i>
578406 *	AFE10-06	6" x 10'	<i>Same as above</i>

B-VENT ADAPTERS

578407	AF3-BVA	3"	DOUBLE WALL B-VENT ADAPTER , aluminum inner/galvanized steel outer, joins flex to "B" vent, UL listed, 6/ctn
578408	AF4-BVA	4"	<i>Same as above</i>
578409	AF5-BVA	5"	<i>Same as above</i>
578410	AF6-BVA	6"	<i>Same as above</i>

FLEXI-SLEEVE

182554	AF4-FS	4" x 10"	FLEXI-SLEEVE FIBERGLASS INSULATION , insulates and protects flex, each 10' length includes (1) blue poly protector sleeve and (3) plastic ties, may be used for both 3" and 4" diameter liner, UL listed, 5/ctn
182555	AF5-FS	5" x 10"	<i>Same as above</i>
182727	AF6-FS	6" x 10"	<i>Same as above</i>

INSTALLATION TOOLS

586059 *	FX3-PD	3"	PULL-DOWN LEADER CONE , UL listed, aluminum, 6/ctn
586060 *	FX4-PD	4"	<i>Same as above</i>
586061 *	FX5-PE	5"	<i>Same as above</i>
586062 *	FX6-PD	6"	<i>Same as above</i>

**FOR ADDITIONAL INFORMATION, VISIT
THE SELKIRK WEBSITE AT www.selkirkcorp.com**

HEATFAB

BLACK 22-GAUGE SAF-T PIPE & FITTINGS



- 22 gauge cold roll steel with welded seam
- Pre-drilled screw holes with screws
- For interior use in the venting of wood and coal stoves and equipment
- Black painted low-luster finish
- Individually wrapped

ID ORDER#	MODEL#	SIZE	DESCRIPTION	CTN QTY
4253	2611B	6"	45° ELBOW , non-adjustable	4
4284	2811B	8"	Same as above	2
4254	2614B	6"	90° ELBOW , non-adjustable	4
4285	2814B	8"	Same as above	4
4249	2602B	6" x 12"	STOVE PIPE , with one end crimped	6
4250	2604B	6" x 18"	Same as above	4
4251	2605B	6" x 24"	Same as above	6
4252	2607B	6" x 36"	Same as above	6
4280	2802B	8" x 12"	Same as above	6
4281	2804B	8" x 18"	Same as above	4
4282	2805B	8" x 24"	Same as above	6
4283	2807B	8" x 36"	Same as above	4
4247	2526B	5" to 6"	STOVE PIPE INCREASER , crimped	4
4262	2627B	6" to 7"	Same as above	4
4263	2628B	6" to 8"	Same as above	4
4278	2728B	7" to 8"	Same as above	4
4260	2624B	6"	TAPERED SLIP CONNECTOR , 18" long slips from 0 - 6"	4
4291	2824B	8"	Same as above	4
4255	2616B	6"	TEE	4
4286	2816B	8"	Same as above	3
4257	2617B	6"	TEE COVER	4
4288	2817B	8"	Same as above	4
4248	2600B	6"	TRIM COLLAR	12

FOR ADDITIONAL INFORMATION, VISIT THE HEATFAB WEBSITE AT www.heatfab.com

NOTE: Per Heat Fab, use Saf-T Vent products only with approved sealants.

HEATFAB

AL29-4C STAINLESS STEEL SAF-T VENT PIPE & ACCESSORIES



- Patented EZ Seal vent system
- All components AL29-4C
- Built-in seal adhered in female end of the vent
- Patented ring and tab secure-fit connections
- For natural gas and propane fuels

- Used for:
 - special gas vent (horizontal or vertical) for mid- and high-efficiency residential gas furnaces, water heaters and boilers
 - ANSI Category I, II, III or IV gas appliances
 - negative and positive pressure vent systems
 - condensing, near-condensing, and non-condensing vent systems

ID ORDER#	MODEL#	SIZE	DESCRIPTION	CTN QTY
EZ SEAL SAF-T VENT PIPE				
80645	9301	3"	EZ SEAL SAF-T VENT PIPE , 6" overall length (4.5" installed length) for use as appliance connector or chimney liner, with gasket	4
80647	9302	3"	Same as above, but 12" overall length (10.5" installed length)	4
80652	9304	3"	Same as above, but 18" overall length (16.5" installed length)	4
80657	9305	3"	Same as above, but 24" overall length (22.5" installed length)	4
84506	9307	3"	Same as above, but 36" overall length (36" installed length)	4
767391	9360-316	3"	Same as above, but 60" overall length (59.5" installed length)	4
ACCESSORIES				
666966	9301PVC	3"	ADAPTER—PVC TO STAINLESS STEEL , for Weil-McLain GV90+	4
697340	9464	4"	APPLIANCE STARTER—STAINLESS STEEL , for Reznor UDAP	4
80607	9311	3"	ELBOW WITH EZ SEAL GASKET , 45°, for vertical or horizontal offsets	4
80611	9314	3"	Same as above, but 90° and <u>tight radius</u>	4
86737	9321	3"	IN-LINE DRAIN WITH EZ SEAL GASKET , 9" length	4
86736	9473RDCR	4" x 3"	REDUCER WITH EZ SEAL GASKET , for sidewall venting applications	4
86735	9390	3"	SCREEN TERMINATION , mitre cut	4
80642	7000RTV (RTV106)	2.8 oz.	SILICONE SEALANT , GE RTV106, used to seal all joints in condensing or positive pressure systems, rated for up to 550°F	12

FOR ADDITIONAL INFORMATION, VISIT THE HEATFAB WEBSITE AT www.heatfab.com

SEPTEMBER 2024

Line #7040

HEATFAB

AL29-4C STAINLESS STEEL SAF-T VENT ACCESSORIES

529.2



ID ORDER#	MODEL#	SIZE	DESCRIPTION	CTN QTY
683359	7001TUBE	--	SILICONE TUBING KIT FOR CONDENSATE DRAIN LINE INSTALLATIONS , (Weil-McLain CGi and CGs boilers), consists of (1) 1/2" x 10' silicone tube, (1) hose clamp and (2) cable ties, silicone tubing rated for 400°F	1
80626	9324	3"	SLIP CONNECTOR WITH EZ SEAL GASKET , 18" length, for use as appliance connector or chimney liner, minimum installed length - 6.25", maximum installed length - 19"	4
134657	9393S	3"	SQUARE THIMBLE , 12" x 12" (= #7393GCS)	4
123344	93WMCGIS	3"	STARTER TEE WITH EZ SEAL GASKET , for Weil-McLain CGi and CGs boiler installations	4
157059	93WMSTXL	3"	Same as above, but for Weil-McLain Series 3 and 4 GV boiler installations	4
215933 *	93WMSTEE	3"	Same as above, but for Weil-McLain VHE boiler installations	4
80624	9323	3"	SUPPORT—HORIZONTAL , used to support interior runs from wall, ceilings or joists, 1" clearance (= #9323/1)	4
568757	4326SS	3"	STORM COLLAR , for Reznor UDAP	4
84503	9392	3"	TERMINATION COUPLING , for wall termination only	4
87053	5390CI	3"	TERMINATION—HORIZONTAL , includes insulated wall thimble	1

* = SPECIAL ORDER ITEM

FOR ADDITIONAL INFORMATION, VISIT THE HEATFAB WEBSITE AT www.heatfab.com



	ID ORDER#	MODEL#	SIZE	CTN QTY
B-VENT ROUND PIPE				
	706418 *	3RP6	3" x 6"	6
	706412 *	3RP12	3" x 12"	6
	706413 *	3RP18	3" x 18"	6
	706414 *	3RP24	3" x 24"	6
	706415 *	3RP3	3" x 36"	6
	706416 *	3RP4	3" x 48"	6
	706417 *	3RP5	3" x 60"	6
	706462	4RPX6	4" x 6"	6
	706456	4RPX12	4" x 12"	6
	706457	4RPX18	4" x 18"	6
706458	4RPX24	4" x 24"	6	
706459	4RPX3	4" x 36"	6	
706460	4RPX4	4" x 48"	6	
706461	4RPX5	4" x 60"	6	
706503	5RP6	5" x 6"	6	
706497	5RP12	5" x 12"	6	
706498	5RP18	5" x 18"	6	
706499	5RP24	5" x 24"	6	
706500	5RP3	5" x 36"	6	
706501	5RP4	5" x 48"	6	
706502	5RP5	5" x 60"	6	
706547	6RP6	6" x 6"	6	
706541	6RP12	6" x 12"	6	
706542	6RP18	6" x 18"	6	
706543	6RP24	6" x 24"	6	
706544	6RP3	6" x 36"	6	
706545	6RP4	6" x 48"	4	
706546	6RP5	6" x 60"	4	
706592	8RP12	8" x 12"	4	
706593	8RP18	8" x 18"	4	
706594	8RP24	8" x 24"	4	
706595	8RP3	8" x 36"	4	
706596	8RP4	8" x 48"	2	
706597	8RP5	8" x 60"	2	

B-VENT ROUND PIPE—ADJUSTABLE



706395 *	3RPA	3" x 12"	6
706443	4RPA	4" x 12"	6
706480	5RPA	5" x 12"	6
706521	6RPA	6" x 12"	6
706581	8RPA	8" x 18"	4

B-VENT ADAPTERS—MALE



706384	3RAA	3"	6
706435	4RAA	4"	6
706473	5RAA	5"	6
706514	6RAA	6"	6

B-VENT ADAPTERS—FEMALE



706842	4RLA	4"	6
706843	5RLA	5"	6
706844	6RLA	6"	6
706445	4RRA	4"	6
706482	5RRA	5"	6
706523	6RRA	6"	6

B-VENT ADAPTERS—OVAL TO ROUND



706433	4OAR	4"	6
--------	------	----	---

B-VENT COLLAR—PIPE

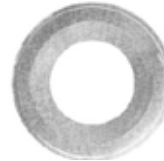

706396 *	3RPC	3"	12
----------	------	----	----

B-VENT COLLAR—STORM



706398	3RS	3"	24
706446	4RS	4"	24
706483	5RS	5"	24
706524	6RS	6"	24
706583	8RS	8"	4

B-VENT DRAFT HOODS





706385 *	3RDH	3"	6
706436	4RDH	4"	6
706474	5RDH	5"	6
706515	6RDH	6"	6
706575	8RDH	8"	4

**FOR ADDITIONAL INFORMATION,
VISIT THE HART & COOLEY WEBSITE AT
www.hartandcooley.com**





	ID ORDER#	MODEL#	SIZE	CTN QTY
	706437	4REA60	4"	12
	706475	5REA60	5"	12
	706516	6REA60	6"	12

	ID ORDER#	MODEL#	SIZE	CTN QTY
	706387 *	3REA90	3"	12
	706438	4REA90	4"	12
	706476	5REA90	5"	12
	706517	6REA90	6"	12
	706577	8REA90	8"	4

	ID ORDER#	MODEL#	SIZE	CTN QTY
	706450	4RTF	4"	6
	706489	5RTF	5"	6
	706530	6RTF	6"	6
	706587	8RTF	8"	6

	ID ORDER#	MODEL#	SIZE	CTN QTY
	706390 *	3RGS	3"	10
	706406	4RGS	4"	10
	706408	5RGS	5"	10
	706410	6RGS	6"	10
	706392	8RGS	8"	5

	ID ORDER#	MODEL#	SIZE	CTN QTY
	706496	4RN5	4" - 5"	6
	706539	4RN6	4" - 6"	6

	ID ORDER#	MODEL#	SIZE	CTN QTY
	706394	3RHW	3"	6
	706442	4RHW	4"	6
	706479	5RHW	5"	6
	706520	6RHW	6"	6
	718495	8RHW	8"	4

	ID ORDER#	MODEL#	SIZE	CTN QTY
	706388	3RF	3"	12
	706439	4RF	4"	12
	706477	5RF	5"	12
	706518	6RF	6"	12
	706578	8RF	8"	4

	ID ORDER#	MODEL#	SIZE	CTN QTY
	706389 *	3RFA	3"	12
	706440	4RFA	4"	12
	706478	5RFA	5"	6
	706519	6RFA	6"	6

	ID ORDER#	MODEL#	SIZE	CTN QTY
	706400 *	3RT3	3"	6
	706448	4RT4	4"	6
	706487	5RT5	5"	6
	706528	6RT6	6"	6

	ID ORDER#	MODEL#	SIZE	CTN QTY
	706401 *	3RTC	3"	1

	ID ORDER#	MODEL#	SIZE	CTN QTY
	706404 *	3RWT	3"	4
	706451	4RWT	4"	4
	706490	5RWT	5"	4
	706531	6RWT	6"	2







	ID ORDER#	MODEL#	SIZE	CTN QTY
	706454	4RYF44	4" x 4" x 4"	6
	706491	5RYF43	5" x 4" x 3"	6
	706492	5RYF44	5" x 4" x 4"	6
	706494	5RYF54	5" x 5" x 4"	6
	706533	6RYF44	6" x 4" x 4"	6
	706535	6RYF54	6" x 5" x 4"	6
	706537	6RYF64	6" x 6" x 4"	6

**FOR ADDITIONAL INFORMATION,
VISIT THE HART & COOLEY WEBSITE AT
www.hartandcooley.com**





FIELD CONTROLS

FANS - DRAFT CONTROLS - AIR PURIFIERS









	ID ORDER#	MODEL#	DUCT SIZE	DESCRIPTION
AIR DUCT BOOSTER FAN				
	46171	JR-2	6"	EVEN AIR BOOSTER FAN , fits flat or round duct, 28W, 120V, 1/7 HP, UL approved, 18 month warranty
BAROMETRIC DRAFT CONTROLS				
	5258	6" RC	5"-6"-7"	BAROMETRIC DRAFT CONTROL—TYPE RC , for oil or coal applications, includes collar, 28.3 sq. inch nominal capacity, 18 month warranty
	5259	7" RC	6"-7"-8"	Same as above, but 38.5 sq. inch nominal capacity
	5261	8" M	7"-8"	BAROMETRIC DRAFT CONTROL—TYPE M , for oil or coal applications, includes collar, 50.3 sq. inch nominal capacity, 18 month warranty
	5263	6" MG1	5"-6"	BAROMETRIC DRAFT CONTROL—TYPE MG1 , for gas applications, double acting, includes collar, 28.3 sq. inch nominal capacity, 18 month warranty
	5264	7" MG1	6"-7"	Same as above, but 38.5 sq. inch nominal capacity
	5265	8" MG1	7"-8"	Same as above, but 50.3 sq. inch nominal capacity
UV-AIRE INDUCT AIR PURIFIERS				
	710888	UV-16/120	16"	UV-AIRE UV-16/120 LAMP UV INDUCT AIR PURIFIER , emits UVC band light rays which sterilize and reduce microorganisms passing through a heating or A/C system, 120V, 0.5 AMPS, 60 Hz, 10 year warranty
	710883	16LAMP	16"	UVC REPLACEMENT LAMP/BULB , for the UV-16/120 air purifier system, 1 year warranty
	710884	18LAMP	18"	Same as above, but for the UV-18 air purifier system

**FOR MORE INFORMATION, VISIT
THE FIELD CONTROLS WEBSITE AT www.fieldcontrols.com**

	ID ORDER#	MODEL #	SIZE	DESCRIPTION	CTN QTY
	578630	110419	4"	ALUMINUM DUCT , 25' length, semi-rigid flexible class 0; 5000 fpm maximum velocity; maximum rated pressure: 6" w.g. pos/neg; 100°F-430°F operating temperature range	16
	144850	110544	4"	ALUMINUM 90° ELBOW , 26 gauge	12
	761736	116042	4" x 2'	ALUMINUM PIPE—RIGID , V030, 26 gauge	25
	726063	112911	4" x 10'	ALUMINUM PIPE—FLEXIBLE, PLAIN ENDS , A220	12
	144855	111381	4"	DRYER VENT KIT , white, assembled, includes hood, aluminum pipe, and collar	8
	144856	111384	4"	Same as above, but brown	8
	458468	110697	--	DRYER VENTING BOX	10
	466758	110754	4"	FRESH AIR INTAKE , <u>white</u> , fixed louver with molded plastic grid	12
	183472	110899	6"	Same as above	12
	685634	110907	8"	Same as above	12
	466759	110974	4"	FRESH AIR INTAKE , <u>brown</u> , fixed louver with molded plastic grid	12
	183473	111008	6"	Same as above	12
	757986	111016	8"	Same as above	12
	144861	110282	4"	LOUVER VENT KIT , <u>white</u> , assembled, includes hood, aluminum pipe, and collar	12
	144862	110283	4"	Same as above, but brown	12
	524634	110838	6"	LOUVER VENT EXHAUST HOOD , plastic, <u>white</u>	12
	757984	110854	8"	Same as above	12
	524636	110842	6"	LOUVER VENT EXHAUST HOOD , plastic, <u>brown</u>	12
	757987	110858	8"	Same as above	12
	10235	110071 (MBC4)	4"	METAL BOLT & NUT CLAMP	100
	774935	RDV4S01	4"	SOFFIT VENT WITH SCREENT , round, white	70
	774937	RDV6S01	6"	Same as above	30

FOR ADDITIONAL INFORMATION, VISIT THE
BUILDER'S BEST WEBSITE AT www.buildersbest.com



	ID ORDER#	MODEL#	DESCRIPTION
EXHAUST FANS & KITS			* = SPECIAL ORDER ITEM
	625094 *	PB110	PREMIUM BATH FAN KIT—SINGLE GRILLE , with grille housing and damper, single phase, 120V, 4" duct, 83 cfm @ 0.4" SP, Energy Star qualified, 7 year warranty
	134953 *	PB190	Same as above, but 6" duct and 152 cfm @ 0.4" SP
	649455 *	PB110H	PREMIUM BATH FAN & LIGHT KIT—SINGLE GRILLE , with grille housing and damper, dimmable halogen bulb, single phase, 120V, 4" duct, 80 cfm @ 0.4" SP, UL listed for wet locations, 7 year warranty
	625096 *	PB270-2	PREMIUM BATH FAN KIT—DUAL GRILLES , with two grille housings, dampers and Y-adapter (4x4x6); single phase, 120V, 4" or 6" duct, 232 cfm @ 0.4" SP, Energy Star qualified, 7 year warranty
	741954 *	PRO100	BATH FAN GRILLE—LOW PROFILE , single phase, 120V, 4" duct connections, 100 cfm @ 0.15" ESP, built-in backdraft damper, ceiling or wall mount, includes 12"-24" bar hanger, HVI and Energy Star certified, 7 year warranty
	741955 *	98509	LED LIGHT GRILLE (OPTIONAL ACCESSORY) , for PRO80 and PRO100 bath fans
EXHAUST FANS CONTROLS			
	455442 *	FD60-EM	ELECTRONIC PUSH BUTTON TIMER , fits standard single gang box; 10, 20, 30 and 60 minute settings; switch plate not included
	675137 *	6637-PW	MULTI-PURPOSE VARIABLE SPEED CONTROL , slide-type with on/off switch; fits standard single gang box; includes white Decora-style switch plate and screws
DRYER EXHAUST FANS			
	134963 *	DBF110	DRYER EXHAUST FAN , thermoplastic resin; integrated automatic pressure switch; for dryer duct runs up to 108'; can be mounted at any angle at any point along duct work; operational LED light on wall panel; 5 year warranty CAUTION: For general ventilation use only. Do not use to exhaust hazardous or explosive material and vapors; do not use with heated air in excess of 140°F

FOR ADDITIONAL INFORMATION, VISIT THE FANTECH WEBSITE AT www.fantech.net



ID ORDER#	MODEL#	DESCRIPTION
-----------	--------	-------------

WHISPERCEILING FANS



747516	FV-0511VQ1	WHISPERCEILING DC FAN , ECM motor with “Pick-A-Flow” airflow selector, 50, 80 or 110 cfm
773476	FV-0511VQL1	Same as above, but <u>with LED light</u>
767784	FV-1115VQ1	WHISPERCEILING DC FAN , ECM motor with “Pick-A-Flow” airflow selector, 110, 130 or 150 cfm
773477	FV-1115VQL1	Same as above, but <u>with LED light</u>
584645	FV20-VQ3	WHISPERCEILING DC HIGH VOLUME FAN , ECM motor with “Pick-A-Flow” airflow selector, 190 cfm
773478	FV30-VQ3	Same as above, but 290 cfm

WHISPERFIT FANS



772560	FV-0511VF1	WHISPERFIT DC REMODELING FAN , ECM motor with “Pick-A-Flow” airflow selector, 50, 80 or 110 cfm
773487	FV-0511VFL1	Same as above, but <u>with LED light</u>

WHISPERGREEN FANS



737754	FV-0511VK2	WHISPERGREEN SELECT FAN , ECM motor with “Pick-A-Flow” airflow selector, 50, 80 or 110 cfm
742489	FV-0511VKL2	Same as above, but <u>with LED light</u>
773471	FV-0511VKS2	WHISPERGREEN SELECT FAN—MULTISPEED , ECM motor with “Pick-A-Flow” airflow selector, 50, 80 or 110 cfm
773472	FV-0511VKS2L2	Same as above, but <u>with LED light</u>
737753	FV-1115VK2	WHISPERGREEN SELECT FAN , ECM motor with “Pick-A-Flow” airflow selector, 110, 130 or 150 cfm
771410	FV-1115VKL2	Same as above, but <u>with LED light</u>

WHISPERRECESSED FANS



745331	FV-08VRE2	WHISPERRECESSED DESIGNER FAN WITH LED LIGHT , 80 cfm
--------	-----------	---

FOR ADDITIONAL INFORMATION, VISIT THE
PANASONIC WEBSITE AT www.na.panasonic.com



ID ORDER#	MODEL#	DESCRIPTION
WHISPERVALUE FANS		
	773490	FV-0510VS1 WHISPERVALUE DC FAN , ceiling or wall-mount, ECM motor with "Pick-A-Flow" airflow selector, 50, 80 or 110 cfm
	771354	FV-0510VSL1 <i>Same as above</i> , but <u>with LED light</u>
	773486	FV-0510VSC1 WHISPERVALUE DC FAN WITH BUILT-IN CONDENSATION SENSOR , ceiling or wall-mount, ECM motor with "Pick-A-Flow" airflow selector, 50, 80 or 110 cfm
	773493	FV-0510VSL1 <i>Same as above</i> , but <u>with LED light</u>
	773492	FV-0810VSS1 WHISPERVALUE DC FAN WITH BUILT-IN MULTI-SPEED , ceiling or wall-mount, ECM motor with "Pick-A-Flow" airflow selector, 50, 80 or 110 cfm
	773807	FV-0810VSSL1 <i>Same as above</i> , but <u>with LED light</u>
	773494	FV-VS43R WHISPERVALUE DC OVAL-TO-ROUND ADAPTER , 24 gauge, 4" oval to 3" round
WHISPERWARM FANS		
	771813	FV-0511VH1 WHISPERWARM DC FAN/HEATER , ECM motor with "Pick-A-Flow" airflow selector, 50, 80 or 110 cfm
	773485	FV-0511VHL1 <i>Same as above</i> , but <u>with LED light</u>
SOFFIT VENTS		
	738661	EZSV14 EZSOFFIT VENT SOFFIT TERMINATION SYSTEM — HIGH PERFORMANCE
PLUG-N-PLAY ACCESSORIES		
	742491	FV-CSVK1 WHISPERGREEN SELECT CONDENSATION SENSOR MODULE
	742490	FV-MSVK1 WHISPERGREEN SELECT SMARTACTION MOTION SENSOR MODULE
	737756	FV-VS15VK1 WHISPERGREEN SELECT MULTI-SPEED MODULE WITH TIME DELAY

FOR ADDITIONAL INFORMATION, VISIT THE
PANASONIC WEBSITE AT www.na.panasonic.com

BROAN

BATHROOM FAN ACCESSORIES



ID ORDER#	MODEL#	DESCRIPTION
600699	BD6	MAKE-UP AIR KIT , includes 6" diameter screened intake hood with collar and damper, less filter
5625	634	ROOF CAP—STEEL , with damper and bird screen, fits 3-1/4" x 10" or up to 8" round duct, 24 gauge steel with black epoxy finish
76478	636	Same as above, but fits 3" or 4" round duct
5627	641	WALL CAP—ALUMINUM , for 6" round duct, includes spring-loaded damper, bird screen and 1-1/4" long attachment collar, .025 aluminum with natural finish; not for dryer venting
27561	643	WALL CAP—ALUMINUM , for 8" round duct, includes spring-loaded damper, bird screen and 3-3/8" long attachment collar, .025 aluminum with natural finish; not for dryer venting
5626	639	WALL CAP—STEEL , for 3-1/4" x 10" duct, includes spring-loaded damper and bird screen, 24 gauge steel with black epoxy finish; not for dryer venting

FOR ADDITIONAL INFORMATION, VISIT THE BROAN WEBSITE AT www.broan-nutone.com

TJERNLUND

EXHAUST & INDUCED DRAFT FANS

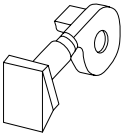
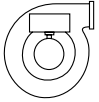

TJERNLUND PRODUCTS, INC.

ID ORDER#	MODEL#	SIZE	DESCRIPTION
	610885	VP-2F	3" POWER VENT KIT , vents any brand or type of Millivolt gas water heater, factory wired, 24V solenoid, adjustable post-purge timer, gas pressure switch, VH1-3 3" vent hood; permits power venting up to 75 equivalent feet, 115V, 60 hz, 50W, 3000 rpm, 1 amp motor; add for vent pipe
		467573	HSJ

MODEL	VENT PIPE DIA.	BTU/HR INPUT	MAXIMUM PIPE LENGTH (FT) AT STACK TEMPERATURE		
			GAS FIRED		OIL FIRED
			300°F	400°F	500°F
HSJ	4"	50,000	100'	100'	100'
		75,000	100'	100'	100'
		100,000	100'	100'	--
		125,000	35'	23'	--

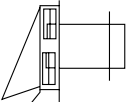
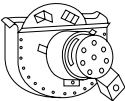
	8924	VH1-3	3"	SIDEWALL VENT HOOD , aluminum, for flue products
	8928	VH1-4	4"	<i>Same as above</i> , but 4"
	8931	VH1-6	6"	<i>Same as above</i> , but 6"
	8893	D-3	5"-8"	IN-LINE DRAFT INDUCER , for oil or gas-fired equipment; 115V, 1 phase, 60 Hz, 1/20 HP
	8894	DJ-3	3"-6"	<i>Same as above</i> , but smaller capacity and 1/70 HP

ACCESSORIES

8919	PS-1505	--	DRAFT PROVING SWITCH , for all models
42378	950-1067	--	RELAY , 24V, for VP-2
11720	950-2075	--	SPILL SWITCH , 200° F, for VP-1 system & VP-2 system

FOR ADDITIONAL INFORMATION, VISIT THE TJERNLUND WEBSITE AT www.tjernlund.com



- Whole home air cleaner
- Completely silent unit operation
- Heavy gauge, preassembled galvanized steel cabinet that is narrow for easier installation and more flexible applications
- Minimal maintenance
- Self-aligning painted door
- MERV11 media permanently traps up to 85% pollen-sized particles and up to 80% of mold- and spore-sized particles
- SelfSeal design reduces air bypass and improves media performance
- UL approved



MODEL 1210



MODEL 1410

WARRANTY

- 5 years from date of installation (does not apply to media)

ID ORDER#	MODEL#	DESCRIPTION
665360	1210	MEDIA AIR CLEANER
665361	1410	MEDIA AIR CLEANER

MEDIA AIR CLEANER SPECIFICATIONS								
Model No.	Resistance @ Airflow Volume (inches w.c. @ CFM)		Nominal Size	Cabinet Size (W x D x H)	Filter Media Area	Removal Efficiency		
						Virus	Dust	Pollen/Mold
1210	.04" @ 600 .06" @ 800 .08" @ 1000 .11" @ 1200	.13" @ 1400 .16" @ 1600 .19" @ 1800 .22" @ 2000	20" x 25"	6.75" x 27.38" x 22.06"	31.4 sq. ft.	--	50% 1-3 Microns	85% 3-10 Microns
1410	.05" @ 600 .07" @ 800 .09" @ 1000 .12" @ 1200	.15" @ 1400 .19" @ 1600 .22" @ 1800 .27" @ 2000	16" x 25"	6.75" x 30.06" x 17.75"	28.3 sq. fit.			

FOR REPLACEMENT MEDIA FILTERS & UPGRADES, SEE PAGE 537.4

FOR ADDITIONAL INFORMATION, VISIT THE APRILAIRE WEBSITE AT www.aprilaire.com

APRILAIRE ELECTRONIC AIR CLEANERS



- Whole home air cleaner
- Completely silent unit operation
- Heavy gauge, preassembled galvanized steel cabinet that is narrow for easier installation and more flexible applications
- Minimal maintenance
- Self-aligning painted door
- Add for programmable thermostat of your choice
- SelfSeal design reduces air bypass and improves media performance
- UL approved



WARRANTY

- 2 years (does not apply to media and inner housing seals)

ID ORDER#	MODEL#	DESCRIPTION
202920	5000	ELECTRONIC AIR CLEANER

ELECTRONIC AIR CLEANER SPECIFICATIONS								
Model No.	Resistance @ Airflow Volume (inches w.c. @ CFM)		Nominal Size	Cabinet Size (W x D x H)	Filter Media Area	Removal Efficiency		
						Virus	Dust	Pollen/Mold
5000	.10" @ 1000	.21" @ 1600	16" x 25"	12" x 31" x 18.25" (FRONT HEIGHT) 12" x 31" x 17.75" (BACK HEIGHT)	72.3 sq. ft.	94%	98%	99%
	.14" @ 1200	.25" @ 1800				.3-1 Microns	1-3 Microns	3-10 Microns
	.17" @ 1400	.29" @ 2000						

FOR REPLACEMENT MEDIA FILTERS, SEE PAGE 537.4

FOR ADDITIONAL INFORMATION, VISIT THE APRILAIRE WEBSITE AT www.aprilaire.com



ID
ORDER# MODEL# DESCRIPTION

AUTOMATIC HUMIDIFIERS



586349 600 **BYPASS HUMIDIFIER**, high-capacity, water-conserving humidifier; includes a built-in bypass damper; can be set to run automatically an entire season; can also be installed in manual mode; equipped with a drain to flush minerals from the system; reversible housing for RH or LH connection; includes saddle valve, transformer and digital control; UL approved; 5 year parts warranty from date of installation



586350 700 **POWER HUMIDIFIER**, high-capacity, water-conserving humidifier; uses an outdoor temperature sensor for monitoring even slight changes in temperature; can be installed in manual mode; equipped with a drain to flush minerals from the system; includes saddle valve and digital control; UL approved; 5 year parts warranty from date of installation

MANUAL HUMIDIFIERS



756743 300 **SELF-CONTAINED HUMIDIFIER**, designed for homes heated with boilers, mini-splits, radiant heat and other ductless systems; simple mounting and installation, easy access panels to wet pack and electrical, quick water panel replacement at bottom of unit; includes Model 65 digital humidistat, saddle valve, 6' power cord, mounting brackets and 10" to 8" reducer and #35 water panel; UL approved; 5 year parts warranty from date of installation



40226 500M **BYPASS HUMIDIFIER**, economy unit; designed for smaller homes; uses a manual humidifier control that can be installed in the living area or on the furnace ductwork; equipped with a drain to flush minerals from the system; includes saddle valve, transformer and manual humidistat control; UL approved; 5 year parts warranty from date of installation



586374 600M **BYPASS HUMIDIFIER**, economy unit; uses the furnace blower to move air through a water panel; includes a built-in bypass damper; can be set to run automatically an entire season; can also be installed in manual mode; equipped with a drain to flush minerals from the system; reversible housing for RH or LH connection; includes saddle valve, transformer and manual humidistat control; UL approved; 5 year parts warranty from date of installation

HUMIDIFIER SPECIFICATIONS							
Model No.	Sq. Ft. Area (avg. house)	Unit Size (W x D x H)	Plenum Opening (W x H)	Capacity (gpd)	Evap. Rate	Feed Rate	Electrical Data
300	3,500	14-3/8" x 22-3/32" x 12-1/2"	--	13	0.50 gph	6 gph	120V, 60 Hz, 0.7 amps
500M	1,500	15-5/8" x 10-1/4" x 13" 6" diameter round opening	9-1/2" x 9-1/2"	12	0.50 gph	3 gph	24V, 60 Hz, 0.5 amps
600/600M	2,000	15-3/8" x 10-1/4" x 15-3/4" 6" diameter round opening	14-3/4" x 14-5/16"	18	0.70 gph	3 gph	24V, 60 Hz, 0.5 amps

NOTE: Models 600 and 700 performance based on: (1) 20°F and 70% R.H. outside air; (2) 70°F and 35% R.H. room air; (3) internal moisture gain of 1 lb/hr; (4) 70% blower operation; (5) 8' ceiling height. Capacity for Model 300 is 13 gpd at 80' effective hard duct length for homes up to 3,500 square feet with tight construction.

FOR HUMIDIFIER ACCESSORIES & PARTS, SEE PAGE 537.4

FOR ADDITIONAL INFORMATION, VISIT THE APRILAIRE WEBSITE AT www.aprilaire.com



- Corrosion-resistant aluminum coils
- Single phase, R-410A
- 8' power cord
- Washable MERV8 filter
- Built-in digital control with interactive display
- 10" round duct collars with retention collar at inlet and outlet
- Convertible top and side air discharge locations
- 3/4" NPT drain connection
- Field-interchangeable control mount from top to front
- 1/2" EPS cabinet insulation
- End-of-line testing with helium leak detection
- Ventilation control options including ASHRAE 62.2-2010



WARRANTY

- 5 years on all parts

ID ORDER#	MODEL#	DESCRIPTION
752078	E080	DEHUMIDIFIER , 80 pints per day water removal with built-in digital control
752082	E100	DEHUMIDIFIER , 100 pints per day water removal with built-in digital control

DEHUMIDIFIER SPECIFICATIONS								
Model No.	Unit Size (W x D x H) (†)	PPD (1)	PPD (2)	CFM @ 0.0" w.c.	CFM @ 0.4" w.c.	En. Factor (1) (L/KW-h)	En. Factor (2) (L/KW-h)	Electrical Data
E080	14" x 26" x 15"	80	65	185	85	2.80	2.35	120VAC, 60 Hz, 5.1 amps
E100	14" x 26" x 15"	100	85	280	210	2.60	2.35	120VAC, 60 Hz, 6.9 amps

PPD (1) is based on 80°F/60% RH
PPD (2) is based on 73°F/60% RH

Energy Factor (1) is based on 80°F/60% RH
Energy Factor (2) is based on 73°F/60% RH

FOR DEHUMIDIFIER ACCESSORIES, SEE PAGE 537.4

FOR ADDITIONAL INFORMATION, VISIT THE APRILAIRE WEBSITE AT www.aprilaire.com

(†) Height does not include adjustable feet, width excludes the filter doors, and length excludes the duct collars.



ID ORDER#	MODEL#	DESCRIPTION
--------------	--------	-------------

AIR CLEANER ACCESSORIES & PARTS

144645 *	255649-102	REPLACEMENT MEDIA AIR FILTERS—MERV8 (TRION) , for MAC2000 20" x 24-1/4" x 5", 3/box
5066	201	REPLACEMENT MEDIA—MERV10 , for 2200 and 2250
123785	401	Same as above, but for 2400
616162	213	REPLACEMENT MEDIA—MERV13 , for 1210, 2210, 3210 and 4200
616163	413	Same as above, but for 1410, 2410, 3410 and 4400
738252	216	REPLACEMENT MEDIA—MERV16 , for 1210, 1620, 2210, 2216, 3210 and 4200
746772	416	Same as above, but for 1410, 1610, 2410, 2416, 3410 and 4400
202942	501	Same as above, but for 5000
5067	4119	SPACER , for 2200, 5/pkg
616160	1213	UPGRADE—MERV13 , for 2200
616161	1413	Same as above, but for 2400

HUMIDIFIER & DEHUMIDIFIER ACCESSORIES

126995	50	CURRENT SENSING RELAY , 24V
682830	76	DEHUMIDIFIER CONTROL—DIGITAL , 24V, wall-mount (dehumidistat)
4864	10	EVAPORATOR PAD , for 110, 220, 500, 500A, 500M, 550 and 558 humidifiers
4866	12	Same as above, but for 112, 224, 225, 440, 445, and 448 humidifiers
78146	35	Same as above, but for 300/350/360, 560, 600, 600A, 600M, 760, and 768 humidifiers
764279	5881	FILTER , for E080 and E100 dehumidifiers
202935	56	HUMIDITY CONTROL—AUTOMATIC WITH DIAL
591301	60	Same as above, but automatic digital
443758	4330	SCALE CONTROL INSERT , for 600, 600A and 600M



HUMIDIFIER PARTS

227856	4187	DRAIN SPUD , for 350 and 360
238879	4223	Same as above, but for 550
591300	4655	HUMIDITY CONTROL—MANUAL , for 500M, 600M and 700M
725176	4793	MAINTENANCE KIT , for 550, 550A and 558
152179	4040	SOLENOID VALVE , 24V, for all humidifier models
227854	4005	Same as above, but 110V and for 110 and 112
227857	4191	SOLENOID VALVE WITH PLASTIC JUNCTION BOX , for 350 and 360
237637	4331	WATER DISTRIBUTION TRAY

FOR ADDITIONAL INFORMATION, VISIT THE APRILAIRE WEBSITE AT www.aprilaire.com

GENERAL FILTERS MEDIA AIR CLEANERS & ACCESSORIES



ID ORDER#	MODEL#	OVERALL SIZE (H x W x D)	DESCRIPTION
 619743	MAC1200 (4520)	16" x 25" x 5" (Filter: 16" x 25" x 3")	MEDIA AIR CLEANER , opti-fiber media with low pressure drop characteristics, 1200 CFM, MERV8 replacement media, metal door, 10 year warranty
 616556	MAC1400 (4510)	16" x 25" x 7" (Filter: 16" x 25" x 5")	MEDIA AIR CLEANER—HIGH EFFICIENCY , opti-fiber media with low pressure drop characteristics, 1400 CFM, MERV11 replacement media, 10 year warranty
623527	MAC2020 (4530)	20" x 20" x 7" (Filter: 20" x 20" x 5")	Same as above
144613	MAC2000 (4500)	20" x 25" x 7" (Filter: 20" x 25" x 5")	Same as above, but 2000 CFM
 144619	MAC-L (4540)	Adjustable for 24" x 8" and 24" x 10" duct (Filter: 20" x 25" x 5")	MEDIA AIR CLEANER—RIGHT ANGLE , opti-fiber media with low pressure drop characteristics, 2000 CFM, MERV11 replacement media, 10 year warranty

ACCESSORIES





 705060	3FM1625 (4521)	16" x 25" x 3"	MERV8 REPLACEMENT FILTER , for MAC1200
624567	6FM1625 (4541)	16" x 25" x 5"	MERV11 REPLACEMENT FILTER , for MAC1400
615379	6FM2020 (4556)	20" x 20" x 5"	Same as above, but for MAC2020
653638	6FM2025 (4551)	20" x 25" x 5"	Same as above, but for MAC2000 and MAC-L
706175	11-GA100A29 (4366)	16" x 25" x 4"	MERV11 REPLACEMENT FILTER , for Honeywell
706176	11-GA100A37 (4368)	20" x 25" x 4"	Same as above
4800	12758	--	MERV11 REPLACEMENT FILTER—EXPANDABLE , for AC1

RESISTANCE (inches W.G.)					
CFM	MAC1200	MAC1400	MAC2000	MAC2020	MAC-L
600	0.05	0.07	0.04	0.07	0.04
800	0.08	0.11	0.06	0.11	0.06
1000	0.12	0.16	0.08	0.16	0.08
1200	0.16	0.22	0.11	0.22	0.11
1400	--	0.28	0.14	0.28	0.14
1600	--	--	0.17	--	0.17
1800	--	--	0.21	--	0.21
2000	--	--	0.26	--	0.26

FOR MORE INFORMATION, VISIT THE GENERAL FILTERS WEBSITE AT www.generalfilters.com

GENERAL FILTERS MANUAL HUMIDIFIERS



	ID ORDER#	MODEL#	SIZE (H x W x D)	DESCRIPTION
	749656	3200M (5800)	12-1/4" x 12" x 8-1/2"	EVAPORATIVE BY-PASS HUMIDIFIER , 24V, up to 12 GPD, includes 6" bypass damper, 9-3/8"W x 9-3/8"H plenum opening, #MHX3C manual humidistat, transformer, solenoid valve, evaporator pad, left or right installation; humidifies up to a <u>3,200</u> square foot home; 5 year warranty
	749657	4200M (5950)	15" x 12" x 8-1/2"	EVAPORATIVE BY-PASS HUMIDIFIER , 24V, up to 17 GPD, includes 6" bypass damper, 9-3/8"W x 12"H plenum opening, #MHX3C manual humidistat, transformer, solenoid valve, evaporator pad, left or right installation; humidifies up to a <u>4,200</u> square foot home; 5 year warranty
	230610	1042LH (5144)	14" x 15-1/8" x 9"	LEGACY SERIES FLOW-THROUGH HUMIDIFIER , 24V, 17 GPD, includes 6" bypass damper, 13-5/8"W x 9-1/2"H plenum opening, #MHX3C humidistat, transformer, solenoid valve, evaporator pad, drain hose, metal distributor tube, 15' x 5/8" drain hose and drain pan; multiple installation options; humidifies up to a <u>2,800</u> square foot home; 5 year warranty
	706173	1099LHS (5015)	16" x 16" x 12-1/4"	LEGACY SERIES FLOW-THROUGH HUMIDIFIER , 24V, 19 GPD, includes 7" bypass damper, 14-1/8"W x 12"H plenum opening, #MHX3C humidistat, transformer, saddle valve, evaporator pad, multiple installation options; humidifies up to a <u>3,000</u> square foot home; 5 year warranty

FOR MORE INFORMATION, VISIT THE GENERAL FILTERS WEBSITE AT www.generalfilters.com

GENERAL FILTERS HUMIDIFIER ACCESSORIES & PARTS



	ID ORDER#	MODEL#	GFI#	DESCRIPTION
	63395	81-22	7104	DRUM ASSEMBLY , for 81 humidifiers
	4802	727-4	7108	<i>Same as above</i> , for 727 and 747-L humidifiers
	465664	65-5	7312	EVAPORATOR SLEEVE , for Model 45 and 65 humidifiers
	4799	81-15	7099	<i>Same as above</i> , but for Model 81 humidifiers
	4809	727-12	7107	<i>Same as above</i> , but for Model 747 and 747-L humidifiers
	4817	727-32	7119	FLOAT BLOCK ASSEMBLY , for Model 727 humidifiers
	37217	81-21	7096	FLOAT VALVE ASSEMBLY , for Model 81 humidifiers
	4819	727-33	--	<i>Same as above</i> , but for Model 727 humidifiers
	715569	MHX3C	7038	HUMIDISTAT—MANUAL DUCT MOUNT , 24V
	4839	727-40	7113	MOTOR ASSEMBLY , for Model 727 and 81 humidifiers
	183485	990-53	7014	SOLENOID VALVE , 24V, for Model 1042 and 1137 humidifiers
	705055	GA4040	7221	<i>Same as above</i> , but for Elite Series and Model 1099LHS humidifiers
	218661	1099-42	7052	<i>Same as above</i> , but for Model 1099 humidifiers
	757951	7225	4200-05	<i>Same as above</i> , but for Model 3200 and 4220 humidifiers
	714138	727-58	7118	TRANSFORMER , 24V, 12A
	4840	975-1	6004	VALVE SEAT , for Model 727, 747, 747L and 1042 humidifiers
	236789	1099-20	7047	VAPOR PAD , for Model 1099 humidifiers
	4845	990-13	7002	<i>Same as above</i> , but for Model 1042 and 1147 humidifiers
	685981	GA570	7900	<i>Same as above</i> , but for Model 570 humidifiers
	656078	GA900	7919	<i>Same as above</i> , but for Model 900 and 1000 humidifiers
	749858	NEW-GA10	7905	<i>Same as above</i> , but for Model 3200M humidifiers
	749857	GA35	7902	<i>Same as above</i> , but for Model 4200M humidifiers

MORE INFORMATION, VISIT THE GENERAL FILTERS WEBSITE AT www.generalfilters.com

TRION

ELECTRONIC AIR CLEANERS & ACCESSORIES



- Corrosion-resistant aluminum coils
- Washable and reusable Forever Filter
- Connects directly to all types of heating and cooling systems
- Permanent, washable aluminum collection cells
- Electronic airflow sensor
- Built-in internal fuse
- Convertible to 240V
- Rugged cabinet construction
- Aluminum mesh pre-filter traps large particles such as lint, dirt and pet hair
- Minimal pressure drop
- Optional odor-reducing charcoal after-filter
- In accordance with ANSI/ASHRAE 52.1/1992 standards
- UL/C-UL listed



WARRANTY

- 5 years on all parts

ID ORDER#	MODEL#	DESCRIPTION	* = SPECIAL ORDER ITEM
155895 *	HE-PLUS-1400	ELECTRONIC AIR CLEANER WITH AIR SWITCH , 7-1/8"W x 24-7/8"D x 20-1/4"H, 1400 CFM	

ACCESSORIES

144795 *	348818-001A	AIR FLOW SENSOR KIT , for HE-1400, HE-PLUS-1400, HE-2000, and HE-PLUS-2000 electronic air cleaners
----------	-------------	---

**FOR ADDITIONAL INFORMATION, VISIT THE
TRION WEBSITE AT www.trioniaq.com**

DUST-FREE ELECTROSTATIC AIR FILTERS



DUST FIGHTER 95 ELECTROSTATIC AIR FILTER

This permanent filter utilizes a configuration of alternate-polarity, self-charging layers of polypropylene filter media. Incorporates the following quality features:

- 95% dust arrestance rating
- Removes molds and pollens — relieves allergy, asthma and hay fever symptoms
- Uses no electricity — produces no ozone
- Keeps furnace and A/C coils clean — reduces energy and repair costs for equipment
- Easy to maintain — washes in soap and water
- 5-year limited warranty

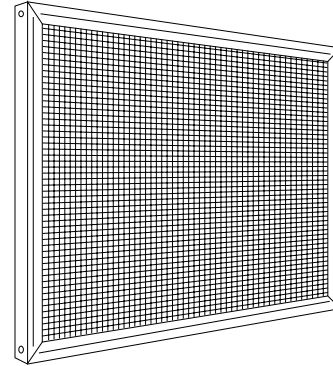

ID ORDER#	DESCRIPTION	SIZE (†)	* = SPECIAL ORDER ITEMS
33370	DUST-FIGHTER 95 PERMANENT AIR FILTER	10" x 20" x 1"	
33371 *	Same as above	12" x 24" x 1"	
33622	Same as above	14" x 20" x 1"	
33623	Same as above	14" x 24" x 1"	
33372	Same as above	14" x 25" x 1"	
33373	Same as above	16" x 20" x 1"	
33374	Same as above	16" x 25" x 1"	
33375	Same as above	20" x 20" x 1"	
33376	Same as above	20" x 25" x 1"	

**FOR ADDITIONAL INFORMATION, VISIT THE
DUST FREE WEBSITE AT www.dustfree.com**

(†) Actual size of filters is 3/8" less in width and length.

PUROLATOR

POLYFIBER & PLEATED DISPOSABLE AIR FILTERS



ID ORDER#	SIZE	CTN QTY
-----------	------	---------

SOLD BY CARTON ONLY

1" POLYFIBER AIR FILTERS (MERV 4 rating)

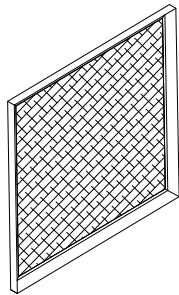

160756	8" x 8" x 1"	12
160755	8" x 16" x 1"	12
160757	10" x 16" x 1"	12
160758	10" x 20" x 1"	12
160759	10" x 24" x 1"	12
160760	10" x 25" x 1"	12
205804	12" x 12" x 1"	12
160762	12" x 20" x 1"	12
160763	12" x 24" x 1"	12
160764	12" x 25" x 1"	12
160765	14" x 20" x 1"	12
160766	14" x 24" x 1"	12
160767	14" x 25" x 1"	12
160769	15" x 20" x 1"	12
160771	16" x 20" x 1"	12
160772	16" x 24" x 1"	12
160773	16" x 25" x 1"	12
175753	18" x 20" x 1"	12
160776	20" x 20" x 1"	12
160777	20" x 22-1/4" x 1"	12
160778	20" x 25" x 1"	12
160779	22" x 22" x 1"	12
214640	24" x 24" x 1"	12
160780	25" x 25" x 1"	12

2" POLYFIBER AIR FILTERS (MERV 4 rating)

175418	12" x 24" x 2"	12
175417	14" x 20" x 2"	12
160784	16" x 20" x 2"	12
160785	16" x 25" x 2"	12
175032	18" x 24" x 2"	12
160786	20" x 20" x 2"	12
160787	20" x 25" x 2"	12
160788	24" x 24" x 2"	12

ID ORDER#	SIZE	CTN QTY
-----------	------	---------

SOLD BY CARTON ONLY

1" PLEATED AIR FILTERS (MERV 8 rating)

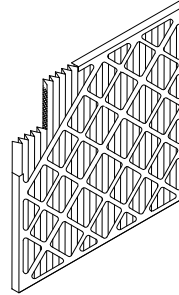

465705	14" x 20" x 1"	12
246818	14" x 24" x 1"	12
444318	16" x 20" x 1"	12
231896	16" x 24" x 1"	12
199694	16" x 25" x 1"	12
584383	20" x 20" x 1"	12

2" PLEATED AIR FILTERS (MERV 8 rating)

713628	16" x 20" x 2"	12
50404	16" x 25" x 2"	12
215852	20" x 25" x 1"	12
67668	20" x 20" x 2"	12
135137	20" x 24" x 2"	12
41401	20" x 25" x 2"	12
135137	24" x 24" x 2"	12

**FOR ADDITIONAL INFORMATION,
VISIT THE PUROLATOR WEBSITE AT
www.purolatorairfilters.com**

SEPTEMBER 2024

Line #6610

PUROLATOR

ROLLED MEDIA and REPLACEMENT CARTRIDGES

541.1





ID ORDER#	MODEL#	SIZE	DESCRIPTION
AIR FILTER ROLLED MEDIA			
56963	P125	25" x 30" x 1"	"HOG'S HAIR" PERMALAST FILTER MEDIA , reusable, heavy duty substitute for fiberglass or foam, <u>30 linear feet per roll</u> ; SOLD BY THE ROLL ONLY
HONEYWELL REPLACEMENT CARTRIDGES			
685885	P25-1	16" x 24-7/8" x 4-3/8" (actual size)	HONEYWELL REPLACEMENT CARTRIDGE , MERV 8, for Honeywell F25 air cleaner #FC100A1029; sold in boxes of 5
193207	P25-2	20" x 24-7/8" x 4-3/8" (actual size)	<i>Same as above</i> , but for Honeywell F25 air cleaner #FC100A1037

**FOR ADDITIONAL INFORMATION, VISIT THE
PUROLATOR WEBSITE AT www.purolatorairfilters.com**

SUPREME STANDS

HEAT PUMP & MINI-SPLIT STANDS



	ID ORDER#	MODEL#	DESCRIPTION
STANDS			
	775014	HPS2430	HEAT PUMP STAND—REVERSIBLE , holds up to 2,000 lbs., telescoping bracket, powder coated, stackable
	775013	MINI1832	MINI-SPLIT STAND , 18" x 32" x 10", holds up to 500 lbs., for 24" x 36" pad
ACCESSORIES			
	775017	R-ANGLE	R-ANGLE KIT , for Reznor UDXC/UDX/UDZ 150 to 400 units
	775015	US24UNV	UNIT HEATER BRACKET KIT , for Reznor USXC/UDX/UDZ 30-125 units, holds up to 400 lbs.
	775009	HPS2430UNV-BRKT	UNIVERSAL BRACKET ONLY , for heat pump stand, set of 2

**FOR ADDITIONAL INFORMATION, VISIT THE
SUPREME STANDS WEBSITE AT www.supremestands.com**

600 SECTION

Motors — Controls — Burners

600 SECTION INDEX

Beckett	614-614.1
Congress Drives	611
Copeland (formerly White-Rodgers)	601-601.9
Crown	616-616.2
Delavan	617-617.2
Erie	603
Fasco	609
Gar-Ber Filters	618
General Filters	618
Honeywell Home	600-600.7
ICM Controls	602
Jaydee	612
Johnson Controls	604
Lau	610-610.1
Mars	608
Maxitrol	613
OEM	614.1
Robertshaw	604
Smoke Detectors	605
Suntec	615
Thermostat wire and cable	606
U.S. Motors	607-607.2
Westwood	616-616.3, 618 (also see 400 section)
White-Rodgers (Emerson)	601-601.9







ID ORDER#	MODEL#	DESCRIPTION
 9565	AT72D1683	TRANSFORMER , 40VA, 120V primary, 26.5V secondary with terminal screws, 9" primary leads, 50/60 Hz, multi-mount: plate, foot or knockout
9570	AT87A1106	TRANSFORMER , power type, with internal fusible link for overload protection, 50VA 120/208/240V primary, 24V secondary, 50/60 Hz, foot or 4" x 4" plate mounting, 13" leads
 9571	AT88A1005	TRANSFORMER , power type with internal fused secondary for overload protection, 75VA, 120V primary, 27V open circuit, 50/60 Hz foot mounted, 12" leads on both primary and secondary
169890	AT88A1047	<i>Same as above</i> , but 480V primary
163060	AT140A1000	TRANSFORMER , 40VA, 120V primary, 27V secondary, foot or 4" x 4" plate-mounted
163147	AT150A1007	TRANSFORMER , 50VA, 120/208/240V primary, 27.5V secondary
9577	C554A1463	PHOTOCELL FLAME DETECTOR , photoconductive, consists of a plug-in cadmium sulfide cell and socket and leadwire assembly, 60" leads, ABJ mounting brackets, fuel line adapter, use with R4166, R8182, R8184, and R8185
 467881	C7089U1006	OUTDOOR TEMPERATURE SENSOR , for VisionPRO Series thermostats, 2-1/4" x 3/8" with 60" leadwires, includes mounting clip and screws, 5-95% RH non-condensing, -40°F to 120°F ambient temperature range, field calibrated, 200' maximum wire run
163114	DP2030A5005	2-POLE CONTACTOR , 24V coil, 30A FLA, 40A resistive
163115	DP2030B5004	<i>Same as above</i> , but 120V coil
 568599	DP3030A5004	3-POLE CONTACTOR , 24V coil, 30A FLA, 40A resistive
163117	DP3040A5003	3-POLE CONTACTOR , 24V coil, 40A FLA, 50A resistive
163118	DP3040B5002	<i>Same as above</i> , but 120V coil
163121	DP3040C5001	<i>Same as above</i> , but 208/240V coil
619669	DP3AUX-1NC	AUXILIARY SWITCH , 1 circuit, normally closed, snap-on, SPST, for DP3030-DP3090 contactors
619667	DP3AUX-1NO	<i>Same as above</i> , but normally opened

FOR ADDITIONAL INFORMATION, VISIT THE HONEYWELL HOME WEBSITE AT www.honeywellhome.com

IMPORTANT: We will not accept under warranty any control where external shorting is evident. Except under warranty, no electrical controls may be returned for credit—*all sales are final.*

HONEYWELL HOME CONTROLS

Honeywell Home

ID ORDER#	MODEL#	DESCRIPTION
183171	L4006A1678	IMMERSION AQUASTAT , (=Weil-McLain #510-312-015), SPST, high or low limit, 100-240°F operating temperature, 5-30°F adjustable differential, 3" insertion
	19719	L4006A1959 IMMERSION AQUASTAT , 40-180°F range, 2 fixed differential, horizontal mount, SPST, breaks on rise, with 2-7/8" bulb
9600	L4006B1155	IMMERSION AQUASTAT , 100-240°F range, 5-30°F adjustable differential, 3" insertion, makes on rise, includes well adapter and paste
	587292	L4006H1004 STRAP-ON AQUASTAT , 130-270°F range, with manual reset
9601	L4008A1015	REMOTE BULB AQUASTAT , opens circuit on temperature rise, 100-240°F, 5' capillary, 5-30°F adjustable differential
9609	L4064B2210	COMBINATION FAN AND LIMIT , furnace control, closes fan & opens limit circuit on temperature rise, manual fan switch, 200°F high limit stop, "fan on" range = 65-215°F, "fan off" range = 50-200°F, high limit temperature range = 100-250°F, 11-1/2" insertion, 3/4" tube, rigid mounting, large cover, screw terminal adapters
9610	L4064B2228	Same as above, but 5" insertion
9611	L4064B2236	Same as above, but 8" insertion
	9620	L6006A1145 AQUASTAT CONTROLLER , horizontal immersion, SPDT switching, range = 100-220°F, 3-3/8", 1/2" pipe, brass spud, less well, adjustable 5-30°F, insulation = 3", vertical or horizontal mounting, stop at 240°F, well adapter, tube of heat conductive compound
9626	L8124G1020	AQUASTAT, TRIPLE , line volt burner circuit with transformer sized to power three low volt valves, vertical case, high limit = 130-240°F, 10°F fixed differential, low limit circuit = 110-220°F, 10-25°F adjustable differential, extra transformer power for 2-zone valves, includes well, 120V, 60 Hz, special well adapter, tube of heat conductive compound, adjustable stop, less spud and well
	9627	L8148A1017 AQUASTAT RELAY , high limit range = 140-240°F, line volt burner circuit, 120V, 60 Hz, less well, special well adapter, tube of heat conductive compound, stop factory set at high limit scale, horizontal or vertical

FOR ADDITIONAL INFORMATION, VISIT THE HONEYWELL HOME WEBSITE AT www.honeywellhome.com

IMPORTANT: We will not accept under warranty any control where external shorting is evident. Except under warranty, no electrical controls may be returned for credit—*all sales are final.*







	ID ORDER#	MODEL#	DESCRIPTION
	162928	L8148E1265	AQUASTAT RELAY—DUAL , with molex plug, high limit range = 180-240°F, line volt burner circuit, 120V, 60 Hz, less well, special well adapter, tube of heat conductive compound, stop factory set at high limit scale
	9628	L8148J1009	AQUASTAT RELAY , same as above but low voltage or milli-voltage burner circuit with three zone capillary manual/auto burner switch, high limit range = 140-240°F, adjustable differential
	9635	M847A1072	DAMPER MOTOR , for wood-fired furnaces, two-position spring return, 24V motor with mounting bracket and damper arm, 30 oz.-inch torque, 45° stroke, 20 second timing
	9637	PA404A1033	PRESSURETROL , closes circuit on pressure fail, redesign differential .5-9 psi, 1-.6 kg/cm2 additive differential
	9644	Q313A1139	POWERPILE GENERATOR GENERATOR , 600-750 mV, 35" lead with "U" clip ends
	9645	Q313A1170	Same as above, but with PG9 adapter
	9646	Q314A4586	PILOT BURNER , non-primary aerated type, B bracket, .018 orifice, 1/4" fitting, F tip with extra .010 orifice unassembled – straight
	61246	Q314A6102	ALL PURPOSE PILOT BURNER , for use with Q340 or Q390 thermocouple or 750 mV Q313 powerpile generator, comes complete with .018" NG or .010" LP orifices – angle right
	672342	Q314U1001	UNIVERSAL PILOT , for standing pilot, includes BCR-18, BBR-10, CAR-12, CAR-13, and BBR-8 orifices, standard and low BTU hoods, adjustable tip style, and universal mounting bracket
	9647	Q327A1626	PILOT BURNER , non-primary aerated wing type, B bracket, .026 orifice, 1/4" fittings, 1" wing span, with (1) .014 orifice, unassembled
	9648	Q340A1066	UNIVERSAL THERMOCOUPLE , 30 mV, 18" lead
	9649	Q340A1074	Same as above, but 24" lead
	9650	Q340A1082	Same as above, but 30" lead
	9651	Q340A1090	Same as above, but 36" lead
	9652	Q340A1108	Same as above, but 48" lead
	169897	Q345A1305	PILOT BURNER & IGNITOR , used with S86, S860, S8610, or S8670 intermittent pilot systems

**FOR ADDITIONAL INFORMATION, VISIT THE HONEYWELL HOME
WEBSITE AT www.honeywellhome.com**

IMPORTANT: We will not accept under warranty any control where external shorting is evident. Except under warranty, no electrical controls may be returned for credit—*all sales are final.*









ID ORDER#	MODEL#	DESCRIPTION
9665	Q633A1007	RELAY RECEPTACLE , plate-mounted, relay cover, eight leadwires
	150429	Q3400A1024 HSI REPLACEMENT IGNITOR SENSOR , 30" lead
9683	R4222D1013	SWITCHING RELAY , general purpose, DPDT, 12 amps, with line volt AC coil, 120V, double QC
169898	R4222D1021	Same as above, but 240V, 6A FLA
	40911	R8184G4009 CADCELL RELAY , oil primary control, 120/24V, 45 second safety timing, with LED lock-out indicator for intermittent ignition oil burner system
9692	R8222D1014	SWITCHING RELAY , DPDT, 12 amp, general purpose, with 24V AC coil, double coil QC terminal
9693	R8225A1017	FAN RELAY , 1/2" spud mount, SPDT, for 24V circuit control
	9694	R8239A1052 FAN CENTER , 40VA transformer, 120V primary, 24V secondary, with plug-in 120V SPDT R8222B relay and metal cover, with one N.O. power and one N.C. power contacts
638580	R8239B1076	Same as above, but 50VA, DPDT, handles multiple voltages (120V, 208V, 240V), consists of transformer and R822D relay mounted on 4 x 4 plate
	217967	R8845U1003 UNIVERSAL SWITCHING RELAY WITH INTEGRAL TRANSFORMER , includes enclosure, two SPST, plus PowerPile® rated low voltage SPST relay, 120V/60 Hz, 7.4 AFL/44.4A ALR on each set of line-voltage contacts, 2000 VA maximum connected load, 2- or 3-wire electrical connections, 24VAC voltage and 0.4A current coil ratings (substitute for RA832A 1066, R845A 1030, R482D 1005 and R882C 1007)
615503	RA889A1001	SWITCHING RELAY WITH INTERNAL TRANSFORMER , enclosed, SPDT line voltage relay, plus SPST low voltage relay with PowerPile rating, 2000 VA, 120V/60 Hz, 15 AFL/30 ALR ratings one line voltage contacts (substitute for RA89A 10074 and R882C 1007)
9702	S483B1002	WINTER WATCHMAN , 120V AC, 120 watt, makes circuit on temperature fall for freeze up warning, 30-60°F range
	9703	S688A1007 AIRFLOW SWITCH (SAILSWITCH) , used to activate air cleaners, humidifiers and auxiliary equipment in reponse to airflow, SPDT, 10" sail insertion length, 24/120/240V

FOR ADDITIONAL INFORMATION, VISIT THE HONEYWELL HOME WEBSITE AT www.honeywellhome.com

IMPORTANT: We will not accept under warranty any control where external shorting is evident. Except under warranty, no electrical controls may be returned for credit—*all sales are final.*







ID ORDER#	MODEL#	DESCRIPTION
 51138	S8610U3009	IGNITION CONTROL , NG or LP, replaces most Honeywell, Robertshaw, Johnson and UTEC intermittent pilot ignition modules, works with single or dual rod/remote sense applications, 100% pilot gas shutoff & lockout on loss of pilot flame (=#S8610U 1003)
706995	S8910U3000	UNIVERSAL HOT SURFACE IGNITION (HSI) MODULE , replaces most White Rodgers, Honeywell and Robertshaw 120V modules, works with single or dual rod systems and comes with plug-in “selector tabs” permitting you to choose ignition timing and from 1-3 trials for ignition (=Roberts Gordon #90436500)
 587198	S9200U1000	UNIVERSAL HOT SURFACE IGNITION (HSI) , integrated furnace control, single-stage heating and cooling, 120V line voltage, 24V low voltage, -40°F to +175°F
622658	ST9120U1011	FAN TIMER CONTROL , 24V, 50/60 Hz
 227012	SV9501M8129	UNIVERSAL SMARTVALVE , <u>fast-fast opening</u> , intermittent HSI pilot, 1/2” x 1/2”, 24V, -40°F to 175°F, NG or LP (includes #393691 NG to LP conversion kit)
172190	SV9502H2522	Same as above, but with <u>slow opening</u> and 0°F to 175°F
617374	SV9520H8513	Same as above, but with <u>fast-slow opening</u> , <u>direct ignition</u> and 0°F to 175°F
551429	T87K1007	THERMOSTAT, HEAT ONLY , round, mercury-free, 24V, 40°F-90°F, 2°F accuracy
 551430	T87N1000	Same as above, but heat/cool
551562	T87N1026	Same as above, (heat/cool) but “easy-to-see” with large raised markings and a click at each 2°F degree setpoint change, includes 6” cover ring, switch position labels, and electronic subbase
 245644	T8775C1005	DIGITAL THERMOSTAT , round, 24V, non-programmable, heat-off-cool, LCD display, power stealing, premier white
61245	TG510A1001	VERSAGUARD THERMOSTAT LOCKING GUARD , clear acrylic cover and base, includes opaque plastic wall plate and tumbler lock with 2 keys, 5-7/8”H x 5-7/8”W x 2-1/2”D
9732	TG511A1000	Same as above, but 6-1/2”H x 7-1/2”W x 2-15/16”D
39122	TG512A1009	Same as above, but 7-1/4”H x 9-3/4”W x 3-3/8”D
 732162	TH1110D2009	T1 PRO THERMOSTAT , non-programmable, 1H/1C, 2.37 sq. inch display, battery or C-wire

FOR ADDITIONAL INFORMATION, VISIT THE HONEYWELL HOME WEBSITE AT www.honeywellhome.com

IMPORTANT: We will not accept under warranty any control where external shorting is evident. Except under warranty, no electrical controls may be returned for credit—**all sales are final.**







ID ORDER#	MODEL#	DESCRIPTION
 732163	TH4110U2005	T4 PRO THERMOSTAT , 7 day/5-2/5-1-1-/non-programmable, 1H/1C HP, 1H/1C conventional, 3.93 sq. inch display, battery or C-wire
720128	TH6220U2000	T6 PRO THERMOSTAT , 7 day/5-2/5-1-1-/non-programmable, 2H/1C HP, 2H/2C conventional, dual fuel, 5.44 sq. inch display, battery or C-wire
 714805	TH8321WF1001	VISIONPRO 8000 THERMOSTAT WITH WIFI , touchscreen, 7 day programmable or non-programmable, 3H/2C heat pump or up to 2H/2C conventional, 32°F to 120°F operating range
 9745	V4043A1259	ZONE VALVE , 3/4" sweat, 120V/60Hz, motorized, normally closed, straight-through valve pattern, closes when power is off, with manual opener, 125°F maximum ambient temperature, 8.0 cv, 8 psi maximum close-off pressure, 125 psi maximum static pressure
9761	V5306B1009	PRESSURE REGULATOR , standard, for use on the V800 family, 3.5" WC setting
		WHILE SUPPLIES LAST
 11970	V8043E1004	ZONE VALVE , 1/2" ID CxC sweat, motorized 2-position valve for hydronic application, five external leadwire connectors, 18" leadwires, normally closed straight valve for controlling flow of hot-cold water, with end switch, with manual opener, conduit fitting, 125°F maximum ambient temperature, 3.5 cv, 15 second opening, 3-4 second closing, 24V, 50/60 Hz
9766	V8043E1012	<i>Same as above</i> , but 3/4" ID CxC sweat
9767	V8043E1020	<i>Same as above</i> , but 1" ID CXC sweat
11968	V8043E1061	<i>Same as above</i> , but 3/4" ID CxC sweat, same as above but with low pressure drop (8.0cv)
11969	V8043E1079	<i>Same as above</i> , but 1" ID CxC sweat, same as above but with low pressure drop (8.0cv)
 748488	V8043E1412	ZONE VALVE—PRO PRESS CONNECTION , 3/4" ID CxC sweat, motorized 2-position valve for hydronic application, five external leadwire connectors, 18" leadwires, normally closed straight valve for controlling flow of hot-cold water, with end switch, with manual opener, conduit fitting, 125°F maximum ambient temperature, 3 C _v at 20 psi, 15 second opening, 3-4 second closing, 24V, 50/60 Hz
748489	V8043E1413	<i>Same as above</i> , but 1" and 8.5 C _v at 6.5 psi

FOR ADDITIONAL INFORMATION, VISIT THE HONEYWELL HOME WEBSITE AT www.honeywellhome.com

IMPORTANT: We will not accept under warranty any control where external shorting is evident. Except under warranty, no electrical controls may be returned for credit—*all sales are final.*



ID ORDER#	MODEL#	DESCRIPTION
 9768	V8043F1036	ZONE VALVE , 3/4" ID CxC sweat w/terminal block, motorized 2-position valve for hydronic application, five terminals, normally closed straight valve for controlling flow of hot-cold water, with end switch, with manual opener, conduit fitting, 125°F maximum ambient temperature, 3.5 cv, 15 second opening, 3-4 second closing, 24V, 50/60 Hz
9769	V8043F1051	<i>Same as above</i> , but 1" ID CxC sweat w/terminal block
11971	V8043F1093	<i>Same as above</i> , but 3/4" ID CxC sweat (8.0cv)
11972	V8043F1101	<i>Same as above</i> , but 1" ID CxC sweat (8.0cv)
777254	V8043F1512	<i>Same as above</i> , but 3/4" ID CxC sweat (3.0cv)
777255	V8043F1513	<i>Same as above</i> , but 1" ID CxC sweat (8.5cv)
 169901	VR8205A2024	COMBINATION GAS VALVE , 1/2" x 1/2", for use with hot surface/direct spark systems in 24V gas-fired appliances up to 200 CFH, includes (1) 1/2" x 3/8" reducer bushing and (1) #393691 natural gas to LP gas conversion kit
 51602	VR8300A3500	GAS VALVE , 1/2" x 3/4", natural gas or LP, 24V, standing pilot, includes (1) 3/4" x 1/2" reducer bushing and (1) #393691 natural gas to LP gas conversion kit
51601	VR8300A4508	<i>Same as above</i> , but 3/4" x 3/4" and includes (2) 3/4" x 1/2" reducer bushings
 163127	VR8345M4302	UNIVERSAL ELECTRONIC IGNITION COMBINATION GAS CONTROL , 3/4" x 3/4", for use with direct spark ignition, hot surface ignition or intermittent pilot ignition in 24V gas-fired appliances up to 415 CFH, includes (2) 3/4" x 1/2" and (1) 1/2" x 3/8" reducer bushings, also includes a natural gas to LP gas conversion kit
 51139	Y8610U6006	INTERMITTENT IGNITION CONTROL SYSTEM , 24V, NG or LP, provides a complete universal retrofit kit for converting standing pilot systems to intermittent spark, includes: S8610U pilot module, VR8304 valve with bushings, LP kit, #392431 sensor assembly, 30" #394800-30 ignition cable with connectors, flanges, screws, wiring harness and adhesive tape (=#Y8610U 1003)

FOR ADDITIONAL INFORMATION, VISIT THE HONEYWELL HOME WEBSITE AT www.honeywellhome.com

IMPORTANT: We will not accept under warranty any control where external shorting is evident. Except under warranty, no electrical controls may be returned for credit—*all sales are final.*





SEPTEMBER 2024

Line #7550

HONEYWELL HOME CONTROLS

600.7
(121371A—40003918)

Honeywell Home







	ID ORDER#	MODEL#	DESCRIPTION
	9799	121371A	WELL ASSEMBLY , 1/2" NPT, 1-1/2" insulation, 3" insertion (= W-M #510-300-010)
	9800	121371B	Same as above, but 3/4" NPT
	9801	121371L	WELL ASSEMBLY , 1/2" NPT, 3" insulation, 3" insertion
	9802	121371M	Same as above, but 3/4" NPT
	10249	386449-1	NUT & SLEEVE , 1/4" OD (= Anchor Brass #181-B)
	9827	390686-1	ORIFICE , LP gas, .010
	75693	390686-4	Same as above, but natural gas
	9831	391937	LP CONVERSION KIT (= Reznor #51749)
	16198	392431	IGNITOR-SENSOR ASSEMBLY , includes ground rod and adapter
	29532	392451-1	ECO (EMERGENCY CUT-OFF) ADAPTER , 1/4 x 1/4, replaces Q356A 1005
	225969	393200-1	ECO (EMERGENCY CUT-OFF) ADAPTER , for VR8300A3500 valve
	33098	393691	NG-LP CONVERSION KIT , for VR8200 valve (= Reznor #98720)
	58287	394588	LP-NG CONVERSION KIT , for VR8200 valve
	9846	802360JA	24V MOTOR REPLACEMENT , for V8043E or F
	734365	40003918-006	POWERHEAD ADAPTER KIT

FOR ADDITIONAL INFORMATION, VISIT THE HONEYWELL HOME
WEBSITE AT www.honeywellhome.com

IMPORTANT: We will not accept under warranty any control where external shorting is evident. Except under warranty, no electrical controls may be returned for credit—*all sales are final.*

COPELAND
(formerly White-Rodgers)
THERMOSTATS







ID ORDER#	MODEL#	DESCRIPTION
 587141	1E30N-910	VERTICAL SET POINT THERMOSTAT-HEAT ONLY, mercury free, single stage (1H), 24V, snap action contact, 50°F to 90°F range, terminals RH and W
 197224	1F78-144	EMERSON 70 SERIES NON-PROGRAMMABLE DIGITAL THERMOSTAT, 1.2" display, single stage (1H/1C), backlit display, 24V or millivolt, system switch (heat/off/cool), fan switch (auto/on), horizontal profile, battery powered, 45°F to 90°F range, terminals RC, RH, W, Y, O, B, and G, includes wallplate
 197223	1F78-151	EMERSON 70 SERIES 5+2 DAY PROGRAMMABLE DIGITAL THERMOSTAT, 1.2" display, single stage (1H/1C), backlit display, 24V or millivolt, system switch (heat/off/cool), fan switch (auto/on), horizontal profile, battery powered, 45°F to 90°F range, terminals RC, RH, W, Y, G, O and B), includes wallplate
 624466	1F80-0261	EMERSON BLUE 5+1+1 DAY PROGRAMMABLE DIGITAL THERMOSTAT, 2" display, single stage (1H/1C), backlit display, 24V or millivolt, system switch (heat/off/cool), fan switch (auto/on), horizontal profile, dual power (hardwired and/or battery), 45°F to 90°F range, terminals R, C, W, Y, G and O/B, includes wallplate
 700563	1F83C-11NP	EMERSON 80 SERIES NON-PROGRAMMABLE DIGITAL THERMOSTAT, 4.5" display, single stage (1H/1C), backlit display, 24V or millivolt, system switch (heat/off/cool), fan switch (auto/on), keypad lockout, temperature limits, horizontal profile, dual power (hardwire and/or battery), 45°F to 99°F range, terminals RH, RC, C, W, Y, G and O/B, wallplate sold separately
 700554	1F83C-11PR	EMERSON 80 SERIES 7-DAY OR 5+1+1 DAY PROGRAMMABLE OR NON-PROGRAMMABLE DIGITAL THERMOSTAT, 4.5" display, single stage (1H/1C), backlit display, 24V or millivolt, system switch (heat/off/cool), fan switch (auto/on), keypad lockout, temperature limits, horizontal profile, dual power (hardwire and/or battery), 45°F to 99°F range, terminals RH, RC, C, W, Y, G and O/B, wallplate sold separately
 700527	1F85U-22NP	EMERSON 80 SERIES NON-PROGRAMMABLE DIGITAL THERMOSTAT WITH CUSTOMIZABLE "AWAY" BUTTON, 5" display, universal single stage (1H/1C), multi-stage (2H/2C) or heat pump (2H/1C) with dual fuel option, backlit display, 24V or millivolt, system switch (heat/off/cool/auto/aux-emergency), fan switch (auto/on), keypad lockout, temperature limits, horizontal profile, dual power (hardwire and/or battery), 45°F to 99°F range, terminals RH, RC, W/E, W2, Y, Y2, O/B/6 and L, wallplate sold separately

FOR ADDITIONAL INFORMATION, VISIT THE
COPELAND (WHITE-RODGERS) WEBSITE AT www.copeland.com

NOTE: Ask your R. A. Townsend Co. sales representative about White-Rodgers' private labeling program.

COPELAND
(formerly White-Rodgers)
THERMOSTATS



ID ORDER#	MODEL#	DESCRIPTION
 711229	1F85U-42PR	EMERSON 80 SERIES 7-DAY OR 5+1+1 PROGRAMMABLE OR NON-PROGRAMMABLE DIGITAL THERMOSTAT , 5" display, universal single stage, multi-stage (2H/2C) or heat pump (2H/1C) with dual fuel option, backlit display, 24V or millivolt, system switch (heat/off/cool/auto/aux-emergency), fan switch (auto/on), keypad lockout, temperature limits, horizontal profile, dual power (hardwire and/or battery), 45°F to 99°F range, terminals RH, RC, C, W/E, W2, Y, Y2, G, O/B/6 and L, wallplate sold separately
 624468	1F86-0244	EMERSON BLUE NON-PROGRAMMABLE DIGITAL THERMOSTAT , 2" display, single stage (1H/1C), backlit display, 24V, system switch (heat/off/cool), fan switch (auto/on), horizontal profile, battery powered, 45°F to 90°F range, terminals R, C, W, Y, G and O/B), includes wallplate with junction box adapter
 642074	1F86EZ-0251	EMERSON BLUE EASY SET DIGITAL THERMOSTAT , 2" display, single stage (1H/1C), 3 pre-sets, backlit display, 24V or millivolt, system switch (heat/off/cool), fan switch (auto/on), horizontal profile, dual power (hardwire and/or batteries), 45°F to 90°F range, terminals R, C, W, Y, G and O/B), includes wallplate and thermostat guard
 721852	1F87U-42WF	SENSI WI-FI 7-DAY PROGRAMMABLE DIGITAL THERMOSTAT WITH REMOTE ACCESS VIA SMARTPHONE, TABLET OR PC , Smart Home compatible with Apple HomeKit, Amazon Alexa and Wink, geofencing and smart alerts, 2-3/4 x 1-3/4" display, universal single stage (1H/1C), multi-stage (2H/2C) or heat pump (4H/2C), humidity display, 24V, system switch (heat/off/cool/auto/aux only), fan switch (auto/on), horizontal profile, dual power (hardwire or batteries), auto changeover, early start, keypad lockout, selectable temperatures, 45°F to 99°F range, terminals RC, RH, C, W/E, W2, Y, Y2*, O/B/6, G and L
 618881	1F95EZ-0671	EMERSON BLUE EASY READER 7-DAY PROGRAMMABLE OR NON-PROGRAMMABLE DIGITAL THERMOSTAT , 4" display, universal single stage (1H/1C), multi-stage (2H/2C) or heat pump (up to 4H/2C), backlit display, 24V or millivolt, system switch (heat/off/cool/auxillary), fan switch (auto/on), horizontal profile, tri-power (R-C) and/or batteries with optional power stealing assist, 45°F to 90°F range, terminals RC, RH, C, G, W/E, W2, Y, Y2, O/B, 6, L

FOR ADDITIONAL INFORMATION, VISIT THE
COPELAND (WHITE-RODGERS) WEBSITE AT www.copeland.com

NOTE: Ask your R. A. Townsend Co. sales representative about White-Rodgers' private labeling program.

COPELAND
(formerly White-Rodgers)
THERMOSTATS







ID ORDER#	MODEL#	DESCRIPTION
 542723	1F95-1277	EMERSON BLUE TOUCHSCREEN PREMIUM 7-DAY OR 5+1+1 DAY PROGRAMMABLE OR NON-PROGRAMMABLE DIGITAL THERMOSTAT , 12" display, universal single stage (1H/1C), multi-stage (2H/2C) or heat pump or dual fuel option (4H/2C), digital remote sensory option, backlit display, 24V or millivolt, auto changeover, system switch (heat/off/cool/auto), fan switch (auto/on), programmable fan, Energy Management Recovery, keypad lockout, horizontal profile, dual power (optional "C" connection and/or batteries), 45°F to 99°F range, terminals RC, RH, C, W, Y, G, O, B, L, 6, +, S and -
 601946	1F95-1291	EMERSON BLUE TOUCHSCREEN 7-DAY PROGRAMMABLE DIGITAL THERMOSTAT , 12" display, multi-stage (2H/2C) or heat pump (up to 4H/2C) with two-mode dehumidification, dual fuel option, backlit display, 24V, auto changeover, system switch (heat/off/cool/emergency/auto), fan switch (auto/on), programmable fan, Energy Management Recovery, digital remote sensory option, keypad lockout, horizontal profile, tripower (hardwire, power stealing and/or batteries), 45°F to 99°F range, terminals RC, RH, C, G, Y, Y2, W/E, W2, O/B, L, +, S, -, 6, DHM and HM
 721865	1F95U-42WF	SENSI TOUCH WI-FI 7-DAY PROGRAMMABLE DIGITAL THERMOSTAT WITH REMOTE ACCESS VIA SMARTPHONE, TABLET OR PC , Smart Home compatible with Apple HomeKit, Amazon Alexa and Wink, geofencing and smart alerts, 5" display, universal single stage (1H/1C), multi-stage (2H/2C) or heat pump (4H/2C), humidity display, 24V, system switch (heat/off/cool/auto/aux only), fan switch (auto/on), horizontal profile, dual power (hardwire or batteries), auto changeover, early start, keypad lockout, selectable temperatures, 45°F to 99°F range, terminals RC, RH, C, W/E, W2, Y, Y2*, O/B/6, G and L
 543118	1F97-1277	EMERSON BLUE TOUCHSCREEN PREMIUM 7-DAY OR 5+1+1 DAY PROGRAMMABLE OR NON-PROGRAMMABLE DIGITAL THERMOSTAT , 12" display, universal single stage (1H/1C) or heat pump (2H/1C), digital remote sensory option, backlit display, 24V or millivolt, auto changeover, system switch (heat/off/cool/auto), fan switch (auto/on), programmable fan, Energy Management Recovery, keypad lockout, horizontal profile, dual power (optional "C" connection and/or batteries), 45°F to 99°F range, terminals (RC, RH, C, W, Y, G, O, B, L, 6, +, S, -

FOR ADDITIONAL INFORMATION, VISIT THE
COPELAND (WHITE-RODGERS) WEBSITE AT www.copeland.com

NOTE: Ask your R. A. Townsend Co. sales representative about White-Rodgers' private labeling program.

REMOTE SENSORS & GAS VALVES







	ID ORDER#	MODEL#	DESCRIPTION
REMOTE SENSORS			
	206733	F145-1328	INDOOR REMOTE SENSOR , 40°F to 99°F operating range, 2-1/8" x 3-1/2" x 3/4", compatible with all White-Rodgers thermostats with wired indoor remote sensor option, 300' maximum distance from thermostat
	512487	F145-1378	OUTDOOR REMOTE SENSOR , with 12' sensor lead, -40°F to 140°F operating range, 2-1/8" x 3-1/2" x 3/4", compatible with all White-Rodgers thermostats with outdoor remote sensing, 300' maximum distance from thermostat
GAS VALVES			
	7849	36C03-300	UNIVERSAL NATURAL-LP STANDING PILOT GAS VALVE , 24V, single stage, <u>fast opening</u> , straight thru with no side outlets, 280,000 BTU/hr maximum capacity at 1"PD, reducer bushings (3/4" to 1/2" and 1/2" to 3/8" NPT), includes LP conversion kit and ECO terminals
	64957	36C03U-433	UNIVERSAL NATURAL-LP STANDING PILOT GAS VALVE , 750 Mv, single stage, <u>fast opening</u> , straight thru with side outlets (plugged), 3/4" x 3/4" NPT, reducer bushings (two 3/4" to 1/2"), includes LP conversion kit and ECO terminals
	7851	36C84-912	UNIVERSAL NATURAL-LP CYCLE-PILOT GAS VALVE , 24V, <u>fast opening</u> , integral gas pressure switch, redundant pilot solenoid main gas regulator, electrical connection on the gas valve for mercury flame sensor connection, 3.5" regulator setting, 3/4" x 3/4" NPT, (2) extra jumpers and (2) 30" leads, plug-in pilot socket on outlet side, reducer bushings, includes LP conversion kit and 1/4" quick connect terminals (C, C, L and S)

FOR ADDITIONAL INFORMATION, VISIT THE
COPELAND (WHITE-RODGERS) WEBSITE AT www.copeland.com

COPELAND
(formerly White-Rodgers)
GAS VALVES

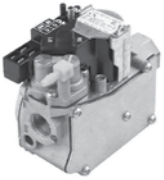
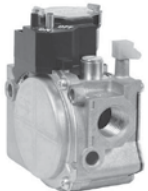

ID ORDER#	MODEL#	DESCRIPTION
 739951	36G22-254	UNIVERSAL HSI/DSI GAS VALVE , 24V, <u>fast opening</u> , single stage, straight thru flow, 1/2" x 1/2" NPT, inlet/outlet pressure taps and filters, (2) 1/4" male spade terminals, pressure tape towers, mounting holes for (8) 32 thread forming screws, includes regulator calibrated to 3.5" W.C. @ 100,000 BTU/Hr (natural gas), for LP add #33099 F92-0659 LP valve spring
 615497	36H32-304	UNIVERSAL HSI/DSI/INTERMITTENT/PROVEN PILOT GAS VALVE , 24V, <u>fast opening</u> , single stage, straight thru flow, 1/2" x 3/4" NPT, electric on/off switch, 1/4" O.D. pilot fitting, reducer bushings (1/2" x 3/4" and 1/2" x 3/8"), includes LP conversion kit
 614060	36H33-412	Same as above, but <u>slow opening</u> , 3/4" x 3/4" NPT, and (2) 1/2" x 3/4" reducer bushings
 669138	36J22-214	UNIVERSAL HSI/DSI GAS VALVE , 24V, <u>fast opening</u> , single stage, 1/2" x 1/2" NPT, reducer bushings (1/2" x 3/8"), inlet/outlet pressure taps, plastic hose barb for connection to 1/4" hose/flexible tubing, includes includes LP conversion kit and regulator calibrated to 3.5 ± 0.3" W.C. @ 100,000 BTU/Hr (natural gas)
 669139	36J24-214	Same as above, but <u>slow opening</u>
 669140	36J24-614	UNIVERSAL HSI/DSI GAS VALVE , 24V, <u>slow opening</u> , single stage, multipoise, 1/2" x 1/2" NPT, reducer bushings, inlet/outlet pressure taps, -40°F to 175°F operating range, regulator calibrated to 3.5 ± 0.3" W.C. @ 90,000 BTU/Hr (natural gas), outlet screen, 90°F bottom outlet, includes LP conversion kit, replaces Carrier 36G24-618P1 (EF32CW206) and 36J24-618P1 (EF32CW210)
 669143	36J54-214	UNIVERSAL HSI/DSI GAS VALVE , 24V, <u>fast opening</u> , two stage , 1/2" x 1/2" NPT, inlet/outlet reducer bushings (1/2" x 3/8" NPT), inlet/outlet pressure taps, plastic hose barb for connection to 1/4" hose/flexible tubing, hi-fire regulator calibrated to 3.5 ± 0.3" W.C. @ 100,000 BTU/Hr, lo-fire regulator calibrated to 1.5 ± 0.3" W.C., includes LP conversion kit

FOR ADDITIONAL INFORMATION, VISIT THE
COPELAND (WHITE-RODGERS) WEBSITE AT www.copeland.com

COPELAND

(formerly White-Rodgers)

ELECTRONIC COMPONENTS



ID ORDER#	MODEL#	DESCRIPTION
 7862	5059-134	PILOT RELITE CONTROL , 24V, spike terminal high voltage connector (=Clare #C097 or Williamson #16-285)
 669147	50A55-743	DIRECT REPLACEMENT INTEGRATED FURNACE CONTROL , for Goodman single stage HSI controls with 120V ignitors, replaces Goodman 0130F00005, 0130F00005S, B1809926, B1809926S, PCBBF110, PCBBF110S, PCBBF112, PCBBF112S, PCBBF123, PCBBF123S and White-Rodgers 50T55-289, 50A55-289
 228173	50A55-843	UNIVERSAL SILICON CARBIDE INTEGRATED HOT SURFACE IGNITION CONTROL , replaces 50A50/50A55-143, -285, -286, -288, -438, -571, and -574, also replaces over 100 Carrier, Goodman, Trane and York controls
 228174	50A65-843	UNIVERSAL SILICON NITRIDE HOT SURFACE IGNITION CONTROL WITH VARIABLE TIMINGS , for 80V ignitors, replaces Goodman, Lennox, Trane and White-Rodgers 50A65-120, -143, -288, -474 and -475
 441373	50D50-843	UNIVERSAL PROVEN PILOT SPARK IGNITION CONTROL WITH VARIABLE TIMINGS , replaces Honeywell #S8610U1003 as well as OEM, Carrier, Trane, York and Lennox
 756576	50D50U-843	UNIVERSAL INTERMITTENT PILOT SPARK IGNITION CONTROL WITH VARIABLE TIMINGS , replaces White-Rodgers #50D50-842 & 843 as well as Honeywell, Fenwal and other controls
 227734	50E47-843	UNIVERSAL SILICON CARBIDE NON-INTEGRATED HOT SURFACE IGNITION CONTROL WITH VARIABLE TIMINGS , 24 VAC, 60 Hz input, replaces all White-Rodgers #50E47-30, -50, -60, -70, -130, -140, -150, -160, -170, -850, -851 and others and virtually all competitive silicon carbide, non-integrated modules (replaces Trane #CNT-1316, Clare #C235, Weil-McLain #10C182/511-330-129), includes everything needed for a fast and accurate replacement, including a complete module cross-reference and program keys to customize the module to the furnace application
 627475	50M56U-843	UNIVERSAL HOT SURFACE IGNITION INTEGRATED FURNACE CONTROL , includes 21D64-2 universal ignitor, replaces over 200 OEM and competitive ignition modules including Carrier, Goodman, Trane and York, kit also includes wire harnesses K & L to replace Carrier controls: HK42FZ004, HK42FZ007, HK42FZ008, HK42FZ009, HK42FZ011 or HK42FZ016

WHILE SUPPLIES LAST

**FOR ADDITIONAL INFORMATION, VISIT THE
COPELAND (WHITE-RODGERS) WEBSITE AT www.copeland.com**

COPELAND
(formerly White-Rodgers)
CONTROLS & ZONE VALVES



	ID ORDER#	MODEL#	DESCRIPTION
CONTROLS			
	625910	16E09-101	ELECTRONIC TEMPERATURE CONTROL , alarm output with selectable delay, SPDT, range -40°F to 220°F, 1°F-30°F differential, does not require additional common wire on 2.5A or higher applications, includes #F136-0114 temperature sensor
	228175	90-113	FAN CONTROL CENTER , 120V, 60 Hz primary, 24V, 40A secondary, SPDT relay, 3/4 hp at 125/250 VAC
	600835	3F05-1	SNAP-DISC FAN CONTROL , 3/4" SPST flanged airstream mount, close on rise, adjustable setpoint, 90°F-130°F range, 20°F fixed differential, auto reset, Therm-O-Disc style 74T12, Type 310708
	600836	3F05-2	<i>Same as above</i> , but adjustable range of 140°F-180°F and Therm-O-Disc Type 310709
	600837	3L05-1	SNAP-DISC LIMIT CONTROL , SPST flanged airstream mount, open on rise, adjustable setpoint, 135°F-175°F range, 40°F fixed differential, auto reset, Therm-O-Disc style 74T11, Type 310710
	217827	3L05-2	<i>Same as above</i> , but adjustable range of 175°F-215°F and Type 310711
	7839	1127-2	SURFACE MOUNT (STRAP-ON) HYDRONIC TEMPERATURE CONTROL , SPDT, 100°F-240°F range, 10°F fixed differential
	9692	90-340	SWITCHING RELAY—2 POLE , DPDT, semi-enclosed, -40°F-130°F range, 50/60 Hz (=Honeywell #R8222D1014)



**FOR ADDITIONAL INFORMATION, VISIT THE
COPELAND (WHITE-RODGERS) WEBSITE AT www.copeland.com**

COPELAND

(formerly White-Rodgers)

ZONE VALVES & IGNITION KITS









	ID ORDER#	MODEL#	DESCRIPTION
HYDRONIC ZONE VALVES			
	16389	1361-102	2-WIRE HYDRONIC ZONE VALVE , for 3/4" I.D. tubing, 15 psi maximum differential across valve, 240°F maximum water temperature, 24V, 60 Hz, 50 psi maximum system pressure
	59433	1361-103	<i>Same as above</i> , but for 1" I.D. tubing
	7840	1361-104	<i>Same as above</i> , but for 1-1/4" I.D. tubing
	191744	1311-102	3-WIRE HYDRONIC ZONE VALVE , for 3/4" I.D. tubing, 15 psi maximum differential across valve, 240°F maximum water temperature, 24V, 60 Hz, 50 psi maximum system pressure
	162180	1311-103	<i>Same as above</i> , but for 1" I.D. tubing
NITRIDE IGNITION KITS			
	669146	21D83M-843	NITRIDE IGNITION REPLACEMENT KIT , for single stage nitride ignition integrated furnace modules, replaces Lennox 83M00 and White-Rodgers 50A62-120, -121, -820, -843
	562484	21D64-2	UNIVERSAL SILICON NITRIDE UPGRADE KIT , 120V, for conversion of silicon carbide (flat or spiral), includes universal brackets, ceramic wire nuts and instructions, 15.5" leads (stripped ends), 5 year warranty
	724888	21D64-44	<i>Same as above</i> , but with 14.5" leads (stripped ends)

**FOR ADDITIONAL INFORMATION, VISIT THE
COPELAND (WHITE-RODGERS) WEBSITE AT www.copeland.com**

COPELAND
(formerly White-Rodgers)
IGNITORS



ID ORDER#	MODEL#	DESCRIPTION
 162815	767A-361	HOT SURFACE IGNITOR , fits most <u>York</u> , 5-1/4" leads, 200°C insulation, electrical connection receptacle with .093" male pins, replaces Robertshaw #41-405
 162811	767A-369	HOT SURFACE IGNITOR , fits most <u>Amana</u> and <u>White-Rodgers</u> , 5-1/2" leads, A style mounting block, sealed combustion, 200°C insulation, electrical connection, molex internal keyed connector with .093" male pins, replaces Robertshaw #41-401
 162814	767A-370	HOT SURFACE IGNITOR , fits most <u>Bryant</u> , <u>Carrier</u> , <u>Trane</u> , and <u>Weil-McLain</u> , 5-1/4" leads, M style mounting block, 200°C insulation, electrical connection, receptacle with .093" male pins, replaces Robertshaw #41-403 and #41-409
 162812	767A-371	HOT SURFACE IGNITOR , fits most <u>DMO</u> , <u>Rheem</u> , and <u>Nordyne</u> , 19-1/8" leads, W style mounting block, left tab, 200°C insulation, stripped ends, replaces Robertshaw #41-402
 190876	767A-373	HOT SURFACE IGNITOR , fits most <u>Goodman</u> , 5-1/4" leads, NM style mounting block, right tab, 200°C insulation, electrical connection, receptacle with .093" male pins, replaces Robertshaw #41-412
 162813	767A-383	HOT SURFACE IGNITOR , fits most <u>Rheem</u> , 5-1/4" leads, N style mounting block, left tab, 200°C insulation, electrical connection, molex side lock connector with .092" male pins, replaces Robertshaw #41-411
 217452	767A-384	HOT SURFACE IGNITOR , fits most <u>Amana</u> , 5-1/4" leads, NM style mounting block, right tab, 200°C insulation, connector with brackets, includes ceramic wire nuts, replaces Robertshaw #41-414







FOR ADDITIONAL INFORMATION, VISIT THE
COPELAND (WHITE-RODGERS) WEBSITE AT www.copeland.com

COPELAND

(formerly White-Rodgers)

MISCELLANEOUS



	ID ORDER#	MODEL#	DESCRIPTION
MISCELLANEOUS			* = SPECIAL ORDER ITEM
	235404	90-380	FAN RELAY , Type 184, 24V coil, 50/60 Hz, SPNO/SPNC
	11961 *	760-401	FLAME SENSOR—UNIVERSAL REPLACEMENT , for hot surface ignition systems, 30" lead, 1/4" female spade terminal (=Clare #R03J003, Clare #C228, replaced by #790-843A1)
	757292	790-843A1	FLAME SENSOR—UNIVERSAL REPLACEMENT , for over 120 part numbers, high temperature rod withstands 2200°F, 30" lead wire with 1/4" quick-connect terminals (3/16" quick-connect terminals included)
	7845	3098-156	FLAME SENSOR—MERCURY , 48" element, 3-pin plug, #20 bulb style, includes adapter fittings, replaces 3098-122, -126, -127, -130, -131, -142, -143, -149, -153, -168, -171, -174, -175 and -182 (=Clare #C096)
	42345	F92-0656	LP TO NATURAL GAS CONVERSION KIT , for use on single stage 36C, D, E, F, G, H and J valves with regulation range of 2.5"-5" WC, includes spring, instructions and sticker
	33099	F92-0659	<i>Same as above</i> , but with regulation range of 7.0"-12" WC
	7874	F67-0918	RESISTOR ASSEMBLY , for use with 36C cycle pilot gas valves with pressure switch (natural gas applications only), plug-in types only, 3098-type mercury flame sensors
	721366	F61-2663	WALL PLATE , for Sensi smart thermostat 1F87U-42WF and 80 Series 1F-42PR/42NP/22PR/22NP, 1F83H-21PR/21NP, or 1F83C-11PR/11NP thermostats, 6-3/4" x 4-1/2", use with or without horizontal junction box

B - D - E TERMINAL PANEL LAYOUTS

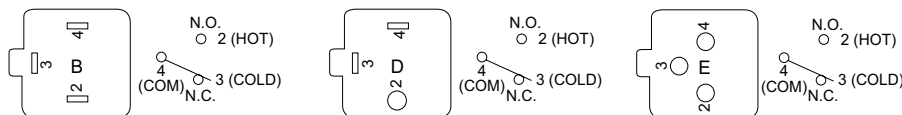

**FOR ADDITIONAL INFORMATION, VISIT THE
COPELAND (WHITE-RODGERS) WEBSITE AT www.copeland.com**

ICM CONTROLS IGNITION CONTROLS



ID ORDER#	MODEL#	DESCRIPTION
669072	ICM271C	IGNITION CONTROL (=Carrier CES0110017, CES0110018, HH84AA010, HH84AA011, HH84AA012, HH84AA013, HH84AA020, P771-7002 and 302075-3; Robertshaw 695-100)
669071	ICM280	IGNITION CONTROL (=ICM280C; Goodman B18099-06/08/10/13/13S; Utec 1012-933D; Texas Instruments 41F-5; White-Rodgers 50T35-730 and 50T35-743)
669070	ICM282B	IGNITION CONTROL (=ICM282A, =ICM282C; Carrier HK42FZ004, HK42FZ007, HK42FZ008, HK42FZ009, HK42FZ1011, HK42FZ013, HK42FZ016 and 325878-751)
669076	ICM283	IGNITION CONTROL (=Honeywell S89, S890 and S8910U-1000; Robertshaw HS780; and White-Rodgers 50E47 and 50F47)
669075	ICM289	IGNITION CONTROL (=all Lennox BCC1, BCC2 and BCC3 circuit boards)
669077	ICM2805A	IGNITION CONTROL (=Nordyne 903106 kit)
748596	ICM2807	IGNITION CONTROL (=Carrier 325879-751 and HK42FZ017)
748591	ICM2811	IGNITION CONTROL (=Goodman PCBBF110/110S, PCBBF123/123S, 0130F00005/005S, PCBBF112/112S, B18099-26/26S11, HH84AA020, HH84AA012, White-Rodgers 50A55-743, 50A55-289 and 50T55-289)
748593	ICM2813	IGNITION CONTROL , replacement for Lennox Surelight board (=Lennox 10M9301, 12L6901, 32M8801, 56L8401, 24L8501, 63K8901, 97L4801, 100925-01, 100925-03, 17W9201, 23W5101, 30W2501, 69M0801, 69M1501, 83M00 and White-Rodgers 50A65-120, 50A65-121, 50A62-120, 50A62-121, 50A62-820, 21D83M-843, 50A66-122 and 50A66-123)
669309	ICM2902	IGNITION CONTROL (=Johnson G77RGD-14)
748522	ICM2907	IGNITION CONTROL (=Reznor 195265)
757475	ICM2918	IGNITION CONTROL (=ICM290A)
353214	ICM102B	TIME DELAY—ADJUSTABLE , universal 18-240 VAC

FOR ADDITIONAL INFORMATION, VISIT
THE ICM CONTROLS WEBSITE AT www.icmcontrols.com



ID ORDER#	MODEL#	DESCRIPTION	* = SPECIAL ORDER ITEM
ZONE VALVE COMPONENTS			
443284	AG13A01A	POP-TOP COMPLETE HEAD ASSEMBLY , spring return two-position actuator, 24V, normally closed, with terminal block, can be installed after the valve body has been installed, fits in baseboard applications, UL-873 listed	
224949 *	AG13A02A	<i>Same as above</i> , but with 18" leads and end switch	
617608 *	VT2317	POP-TOP VALVE BODY , 3/4" sweat, 2-way, 32°F to 200°F (fluid) at 104°F ambient, 8.0 CV	
633951 *	VT2417	<i>Same as above</i> , but 1" sweat	
399522	VT2517	<i>Same as above</i> , but 1-1/4" sweat	
ZONE VALVE MOTORS			
138267 *	30-118-A	REPLACEMENT MOTOR FOR POP-TOP ACTUATOR AND "C" CLASSIC VALVES , (#0747C0335TA01), 24V, 60 Hz, class "F" rated temperature, 250°F fluid, 169°F ambient	
REBUILD KITS			
456391	100-081	2-WAY VALVE BODY REBUILD KIT , 7.0 CV	
212112	100-082	<i>Same as above</i> , but 8.0 CV	

ID ORDER#	MODEL#	DESCRIPTION
JOHNSON CONTROLS LINE #7605		
170907	P70AB-12C	LOW PRESSURE CONTROL , used for low pressure on R-12 refrigeration units
170908	P70AA-118C	FAN CYCLE CONTROL , used for low ambient control, cycles fan on and off to maintain head pressure
ROBERTSHAW LINE #7600		
225418	720-474	GAS VALVE , NG/LP, 24V, standing pilot, step opening

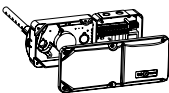
ID ORDER#	MODEL#	DESCRIPTION
	623735 SL-2000-P (105792)	ACI PHOTOELECTRIC LOW-FLOW DUCT SMOKE DETECTOR , 4-wire, 24 VAC/DC or 120/240 VAC, air velocity rating from 100 to 4000 feet per minute, two DPDT form C relay contacts, interconnectability for multi-fan shutdown (up to 10 air handling systems), telescopic sampling tube, cover tamper trouble signal, UL listed, 3-year warranty
623736	S1-STN-2.5	YORK METAL SAMPLING TUBE , 30", for SL-2000-P duct detector, for 1-2' duct widths (= STN-2.5)
623737	S1-STN-5.0	<i>Same as above</i> , but 5" and for 2-4' duct widths (= STN-5.0)

SOUTHWIRE

THERMOSTAT WIRE & CABLE



ID ORDER#	MODEL#	SERIES#	DESCRIPTION
--------------	--------	---------	-------------

NON-RISER UL-APPROVED

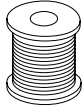

32431	47104807	18-2UL	NON-RISER THERMOSTAT WIRE , UL approved, type CL2, 500' roll
38034	47114807	18-3UL	<i>Same as above</i>
49508	47120307	18-4UL	<i>Same as above</i> , but 250' roll
32432	47130307	18-5UL	<i>Same as above</i>
248161	47140307	18-6UL	<i>Same as above</i>
143482	47160307	18-8UL	<i>Same as above</i>

SHIELDED STRANDED CONTROL CABLE

740451	12165009	18-6UL	SHIELDED STRANDED CONTROL CABLE , UL approved, type CL2, 500' roll
--------	----------	--------	---

STRANDED MINI-SPLIT CABLE

692314	10703908	14-4	STRANDED MINI-SPLIT CABLE , black, THHN 600V, 50' coil
778808	10700108	14-4	<i>Same as above</i> , but 250' reel



ID ORDER#	MODEL#	HP	DESCRIPTION
-----------	--------	----	-------------

BELT DRIVE BLOWER MOTORS



55201	8000	1/4 HP	BLOWER MOTOR—BELT DRIVE , 1-speed reversible, 1725 RPM, 115V, 1/2" shaft with 5/8" adapter box, automatic overload, 48Y frame
55202	8100	1/3 HP	Same as above, but 1/3 HP
55203	8200	1/2 HP	Same as above, but 1/2 HP



699870	D34CPA2PH9	3/4 HP	BLOWER MOTOR—BELT DRIVE , 1-speed reversible, 1725 RPM, 115/208-230V dual voltage, 1/2" shaft with 5/8" adapter box, automatic overload, 56H frame,
--------	------------	--------	--

DIRECT DRIVE BLOWER MOTORS (add for capacitor)



584801	1864	1/3 HP	BLOWER MOTOR—DIRECT DRIVE , 3-speed reversible, 1075 RPM, 115V, automatic overload, add for 7.5 MFD capacitor (Nortek #01-0003)
584802	1865	1/2 HP	Same as above, but 1/2 HP and add for 10 MFD capacitor (Nortek #01-004)
584803	8904	3/4 HP	Same as above, but 3/4 HP and add for 15 MFD capacitor (Nortek #01-0006)
584805	8905	3/4 HP	Same as above, but 3/4 HP and 208-230V

RESCUE DIRECT DRIVE PSC BLOWER MOTORS (add for capacitor)



585482	5460	1/2-1/6 HP	RESCUE DIRECT DRIVE PSC BLOWER MOTOR , 4-speed reversible, 1075 RPM, 115V, automatic overload, angle mount; 1/3-1/6 HP add for 7.5 MFD capacitor (Nortek #01-0003); 1/2 HP add for 10 MFD capacitor (Nortek #01-0004)
585484	5461	1/2-1/6 HP	Same as above, but 208-230V, 1/3-1/6 HP add for 5 MFD capacitor (Nortek #01-0001) and 1/2 HP add for 10 MFD capacitor (Nortek #01-0004); for 10% stronger motor on 1/3-1/6 HP motors, add for 7.5 MFD capacitor (Nortek #01-0003)
585481	5470	3/4-1/5 HP	Same as above, but 115V, 1/2-1/5 HP add for 10 MFD capacitor (Nortek #01-0004) and 3/4 HP add for 20 MFD (Nortek #01-0007)

RESCUE ECOTECH ECM BLOWER MOTORS (no capacitor required)



692414	5522ET	1/3-1/5 HP	RESCUE ECOTECH ECM BLOWER MOTOR , 5-speed reversible, 1075 RPM, 115V/208-230V dual voltage, 48 frame
655011	5532ET	1/2-1/4 HP	Same as above
692415	5542ET	3/4-1/3 HP	Same as above

FOR CAPACITORS, SEE PAGE 607.2

FOR ADDITIONAL INFORMATION, VISIT THE U.S. MOTORS WEBSITE AT www.acim.nidec.com



ID ORDER#	MODEL#	HP	DESCRIPTION
--------------	--------	----	-------------

RESCUE EZ13 UNIVERSAL ECM BLOWER MOTORS (no capacitor required)



761907	5632	1/2-1/3 HP	RESCUE EZ13 UNIVERSAL ECM BLOWER MOTOR, 5-pin, pre-programmed, fixed speed reversible, 1075 RPM, 115/208/230V, 6.3/4.0-3.8 amp, 48 frame, with built-in 6,000 volt surge protection
761908	5642	3/4 HP	<i>Same as above, but 3/4 HP and 9.3/5.8-5.4 amp</i>

RESCUE EZ16 UNIVERSAL ECM BLOWER MOTORS (no capacitor required)



761914	5862	1/2-1/3 HP	RESCUE EZ16 UNIVERSAL ECM BLOWER MOTOR, 16-pin, variable speed (you select your voltage and HP and adjust airflow to meet your requirements), 1075 RPM, auto-rotation (CCW or CW), 115/208/230V, 6.4/4.0-3.8 amp, 48 frame, with built-in 6,000 volt surge protection
761915	5861	3/4-1/3 HP	<i>Same as above, but 3/4-1/3 HP and 6.4/4.0-3.8 amp</i>

RESCUE SELECTPRO ECM BLOWER MOTORS (no capacitor required)



761910	6633	1/2-1/3 HP	RESCUE SELECTPRO ECM BLOWER MOTOR—PROGRAMMABLE WITH INTEGRATED BLUETOOTH TECHNOLOGY, 5-pin, fixed speed/constant torque, programmable rotation (CCW or CW), 1075 RPM, 115V/208-230V, 6.3/4.0-3/8 amp, 48 frame, with built-in 6,000 volt surge protection
761911	6643	3/4 HP	<i>Same as above, but 3/4 HP and 9.3/5.8-5.4 amps</i>
761912	6653	1 HP	<i>Same as above, but 1 HP and 12.4/7.8-7.2 amps</i>

FOR ADDITIONAL INFORMATION, VISIT THE U.S. MOTORS WEBSITE AT www.acim.nidec.com

U.S. MOTORS

CONDENSER FAN, OIL BURNER & SPECIALTY MOTORS



ID ORDER#	MODEL#	HP	DESCRIPTION
--------------	--------	----	-------------

RESCUE CONDENSER FAN MOTORS (add for capacitor)



585558	5462	1/3-1/6 HP	RESCUE CONDENSER FAN MOTOR , 2 speed, reversible, 1075 RPM, 208-230V; 208V HP motors add for 7.5 MFD capacitor (Nortek #01-0003) and 230V HP motors add for 5 MFD capacitor (Nortek #01-0001); 2.6/1.8 amps (note: amps vary depending on capacitor selected)
--------	------	------------	--

OIL BURNER MOTORS



55211	3083	1/7 HP	OIL BURNER MOTOR , 3450 RPM, 115V, manual reset, reversible, 20" leads, 48M frame, open, 1/2" shaft
55212	3252	1/6 HP	<i>Same as above</i> , but 1725 RPM and enclosed

SPECIALTY MOTORS



218246	3255	1/12 HP	CIRCULATOR PUMP MOTOR , (= Bell & Gosset #111034, A.O. Smith #939)
--------	------	---------	---

DIRECT DRIVE MOTOR ACCESSORIES

584793	17	--	DIRECT DRIVE BLOWER MOUNTING RING SET , double wire type, for 5.6" diameter motor (10" blower mount diameter), includes motor support ring, (3) rubber mounting bushings with sleeves and mounting screws
584792	44	--	DIRECT DRIVE BELLY BAND BLOWER MOUNTING RING SET , E band torsion type, for 5.6" diameter motor (9" or 10" blower mount diameter), includes motor support ring with welded ears

CAPACITORS

45547	01-0001	--	RUN CAPACITOR , 5 MFD, 370V oval metal
203059	01-0003	--	<i>Same as above</i> , but 7.5 MFD
45546	01-0004	--	<i>Same as above</i> , but 10 MFD
203060	01-0006	--	<i>Same as above</i> , but 15 MFD
585508	01-0007	--	<i>Same as above</i> , but 20 MFD

FOR ADDITIONAL INFORMATION, VISIT THE U.S. MOTORS WEBSITE AT www.acim.nidec.com



ID ORDER#	MODEL#	HP	DESCRIPTION
--------------	--------	----	-------------

DIRECT DRIVE BLOWER MOTORS (add for capacitor)



753882	10585	1/3 HP	BLOWER MOTOR—DIRECT DRIVE , 3-speed reversible, 1075 RPM, 36" lead length, 115V, 6.1 amps, requires a 5/370 capacitor
753883	10587	1/2 HP	<i>Same as above</i> , but 1/2 hp, 7.5 amps and requires a 10/370 capacitor
753888	10589	3/4 HP	<i>Same as above</i> , but 3/4 hp, 11.2 amps and requires a 15/370 capacitor

MULTI-HP DIRECT DRIVE BLOWER MOTORS (add for capacitor)



753891	10463	1/6-1/2 HP	MULTI-HP DIRECT DRIVE BLOWER MOTOR , 4-speed reversible, 1075 RPM, 41" lead length, 115V and 1/2 HP requires a 15/370 capacitor (all other HP require a 5 or 7.5/370 capacitor)
753892	10464	1/6-1/2 HP	<i>Same as above</i> , but 1/6-1/2 HP, 208-230V and 1/2 HP requires a 10/370 capacitor (all other HP require a 5 or 7.5/370 capacitor)
753893	10466	1/5-3/4 HP	<i>Same as above</i> , but 3/4-1/5 HP, 115V and 3/4 HP requires a 20/370 capacitor (all other HP require a 10/370 capacitor)

QUICKSWAP AZURE MOTOR (no capacitor required)



753897	10865	1/3-1/2 HP	QUICKSWAP AZURE MOTOR , 5-speed/torque taps (reversible+forward), 36" lead length, 115V/230V, 48 frame
753898	10866	3/4-1 HP	<i>Same as above</i> , but 3/4-1 HP

OUTDOOR PSC CONDENSER FAN MOTORS (add for capacitor)



753901	10728	1/4 HP	OUTDOOR PSC CONDENSER FAN MOTOR , 1-speed, reversible, 1075 RPM, 36" lead length, 208-230V, 1.8 amps, 5/370 capacity requirement
753902	10729	1/3 HP	<i>Same as above</i> , but 1/3 HP, 2.4 amps and 7.5/370 capacity requirement
753903	10730	3/4 HP	<i>Same as above</i> , but 3/4 HP, 3.5 amps and 10/370 capacity requirement

MULTI-HP PSC CONDENSER FAN MOTORS (add for capacitor)





753906	10465	1/6-1/3 HP	MULTI-HP PSC CONDENSER FAN MOTOR , 2-speed, reversible, 1075 RPM, 38" lead length, 208-230V
--------	-------	------------	--

FOR ADDITIONAL INFORMATION, VISIT
THE MARS WEBSITE AT www.marsdelivers.com

WARRANTY: 12 months in service not to exceed 18 months from date of manufacture.



FASCO INDUCER FAN MOTORS



	ID ORDER#	MODEL#	HP	DESCRIPTION
	213438	A081	1/40 HP	INDUCER FAN MOTOR , 1-speed, 3100 RPM, 230V, 80 cfm, 0.5 amp, 50/60 Hz, shaded pole, thermal overload protection, open enclosure type, 104°F maximum ambient temperature, OEM: Magic Chef
	725181	D1190	1/30 HP	INDUCER FAN MOTOR , 1-speed, 3000 RPM, 115V, 1.6 amp, 60 Hz, shaded pole, thermal overload protection, 5/16" shaft diameter, 1-3/4" shaft length, all angle mounting, open enclosure type; for Weil-McLain HE Series

**FOR ADDITIONAL INFORMATION, VISIT
THE FASCO WEBSITE AT www.pemsmotors.com**





	ID ORDER#	MODEL#	SIZE	DESCRIPTION	* = SPECIAL ORDER ITEM
	4611 *	38-2095-01	1" x 25"	BLOWER SHAFT , ground and polished, excess may be cut off	
	4612 *	38-2096-01	3/4" x 20"	Same as above	
	4613 *	38-2205-01	5/8" x 20"	Same as above	
	5896	38-2696-01	3/4"	CARTRIDGE BEARING , pair, bronze sleeve type with 1-11/16" OD OD rubber sleeve (=Brundage #5111212)	
	5897	38-2691-01	1"	Same as above, but 1" shaft (=Brundage #5111613)	
	4577	38-2272-01	3/4"	CARTRIDGE BEARING , pair, bronze sleeve, 1-13/16" OD, supplied with a journal instead of thrust collar; the journal is actually a steel repair sleeve that fits over a scored shaft; ideal for repair without changing entire blower shaft	
	4578	38-2090-01	1"	CARTRIDGE BEARING ONLY , pair, bronze sleeve, 1-13/16" OD	
	4580	38-2094-01	1"	CARTRIDGE BEARING , pair, heavy duty, with bronze sleeve and press-in oil tubes, 2-1/2" OD	
	4582	38-2404-01	5/8"	CARTRIDGE BEARING , pair, with bronze sleeve and press-in oil tubes, 1-13/16" OD	
	4584	38-2442-01	3/4"	Same as above	
	4617	38-2525-01	--	MOTOR ADJUSTMENT RUBBER GROMMET , used with tailpiece assembly to reduce vibration and noise, bag of 6	
	15900 *	02-8957-31	4-3/4" x 3-3/16"	OIL BURNER BLOWER WHEEL—CLOCKWISE	
	4588	38-2086-01	3/4"	PILLOW BLOCK SLEEVE BEARING , pair, with heavy neoprene cushion, two 1/8" rubber spacers provided	
	4591	38-2087-01	1"	Same as above	
	4592	38-2204-01	5/8"	Same as above	
	4609	38-2209-01	--	RUBBER PADS , used to eliminate wear and vibration on fans, 7/8" diameter, bag of 12	

* = SPECIAL ORDER ITEM

FOR ADDITIONAL INFORMATION, VISIT
THE LAU WEBSITE AT www.lauparts.com



LAU BLOWER PARTS

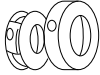

	ID ORDER#	MODEL#	SIZE	DESCRIPTION	* = SPECIAL ORDER ITEM
	4574	02-9175-01	3/4"	SLEEVE BEARING BRACKET KIT , pair, designed to retrofit blowers from 9" to 16" in size	
	4575	02-9176-01	1"	<i>Same as above</i>	
	4594	38-2443-01	5/8"	SLEEVE SEALED TYPE BEARING , pair, with insulator, factory packed with plastic petroleum, 1-13/16" OD	
	151820	38-2443-02	3/4"	<i>Same as above</i>	
	4597	38-2203-01	3/4"	THRUST SLEEVE AND SPACER KIT , pair, designed to eliminate end-play; plastic sleeve with assorted spacers handle most adjustments	
	4599	38-2206-01	3/4"	THRUST COLLAR KIT , includes (2) set screws, (2) collars and (2) thrust washers	
	4601	38-2207-01	1"	<i>Same as above</i>	
	4603 *	38-2431-01	5/8"	<i>Same as above</i>	
	4605 *	38-2491-01	5/8"	THRUST SPACER KIT , bag of 12	
	11702	38-2491-02	3/4"	<i>Same as above</i>	
	4607 *	38-2491-03	1"	<i>Same as above</i>	
	4615	38-2523-01	--	UNIVERSAL MOTOR ADJUSTMENT KIT , including tailpiece assembly, bolts, bracket and grommet	

FOR ADDITIONAL INFORMATION, VISIT
THE LAU WEBSITE AT www.lauparts.com

CONGRESS DRIVES FAN ACCESSORIES

	ID ORDER#	MODEL#	SIZE DIA. x BORE	DESCRIPTION	* = SPECIAL ORDER ITEM
	5698	CA-500	5" x 3/4"	"A" GROOVE SOLID PULLEY	
	5745	CA-500	5" x 1"	Same as above	
	5700 *	CA-600	6" x 5/8"	"A" GROOVE SPOKE PULLEY	
	5701	CA-600	6" x 3/4"	Same as above	
	5704	CA-700	7" x 3/4"	Same as above	
	5705	CA-700	7" x 1"	Same as above	
	5706	CA-800	8" x 3/4"	Same as above	
	5708 *	CA-900	9" x 3/4"	Same as above	
	5711 *	CA-1000	10" x 3/4"	Same as above	
	5746	CA-1000	10" x 1"	Same as above	
	5714 *	CA-1200	12" x 3/4"	Same as above	
	5715 *	CA-1200	12" x 1"	Same as above	
	5716	VP325	3-1/4" x 1/2"	VARIABLE PITCH PULLEY	
	5717	VP325	3-1/4" x 5/8"	Same as above	
	5719	VP350	3-1/2" x 1/2"	Same as above	
	5721	VP350	3-1/2" x 5/8"	Same as above	
	5723	VP400	4" x 1/2"	Same as above	
	5724	VP400	4" x 5/8"	Same as above	
	5725	VP450	4-1/2" x 1/2"	Same as above	
	5726	VP450	4-1/2" x 5/8"	Same as above	

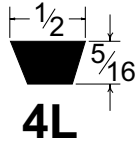

ID ORDER#	MODEL#	LENGTH
170724	4L-200	20"
170725	4L-210	21"
170726	4L-220	22"
170727	4L-230	23"
170729	4L-240	24"
170731	4L-250	25"
170732	4L-260	26"
170733	4L-270	27"
170734	4L-280	28"
170735	4L-290	29"
5072	4L-300	30"
5073	4L-310	31"
5076	4L-320	32"
5077	4L-330	33"
5078	4L-340	34"
5079	4L-350	35"
5080	4L-360	36"
5081	4L-370	37"
5082	4L-380	38"
5083	4L-390	39"
5084	4L-400	40"
5085	4L-410	41"
5086	4L-420	42"
5087	4L-430	43"
5088	4L-440	44"
5089	4L-450	45"
5090	4L-460	46"
5091	4L-470	47"
5092	4L-480	48"
5093	4L-490	49"

ID ORDER#	MODEL#	LENGTH
5095	4L-500	50"
5096	4L-510	51"
5097	4L-520	52"
5098	4L-530	53"
5099	4L-540	54"
5100	4L-550	55"
5101	4L-560	56"
5102	4L-570	57"
5103	4L-580	58"
5104	4L-590	59"
5105	4L-600	60"

MIX FOR DISCOUNT NOTE:

Less 5% on orders of 6 to 11 mixed belts. Less 10% on orders of 12 or more mixed belts.

**FOR ADDITIONAL INFORMATION, VISIT
THE JAYDEE WEBSITE AT
www.jdv-belts.com**

MAXITROL GAS ACCESSORIES

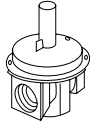

ID ORDER#	MODEL#	SIZE	DESCRIPTION
7616	RV52	1/2"	GAS PRESSURE REGULATOR , 7.5" primary, 3" to 6" secondary
7617	RV53	3/4"	<i>Same as above</i>
7618	RV53	1"	<i>Same as above</i>
30288	RV48	1/2"	<i>Same as above</i> , but 11" primary, 3" to 6" secondary, lock up type
30289	RV48	3/4"	<i>Same as above</i>
61541	325-5	3/4"	HIGH PRESSURE GAS REGULATORS , lever acting, inlet pressure to 10 psi, outlet pressures of 1.0" to 12" w.c.
7621	12A06	--	VENT LIMITING ORIFICE
58299	R500Z	1/2"	ZERO PRESSURE GAS REGULATORS , ("zero governor") equipped with a counter spring beneath the valve for use in the normal upright position, may be used for modulating burners where gas flow rate varies. Maximum inlet pressure of 1 psi is recommended and outlet pressure may be adjusted to -1.0" to +1.5" w.c. At any given flow rate, the regulation accuracy is ± 0.2 " w.c. over varying inlet pressures up to 1 psi.

**FOR ADDITIONAL INFORMATION, VISIT
THE MAXITROL WEBSITE AT www.maxitrol.com**

BECKETT BURNERS, BURNER PARTS & ACCESSORIES



ID ORDER#	MODEL#	DESCRIPTION
--------------	--------	-------------

BURNERS

NOTE: For a complete burner, order chassis, air tube combination and mounting flange.



228302	B2007	"AFG" CHASSIS ONLY , includes a one-stage Beckett CleanCut pump, with delayed #5669 oil valve (rated at up to 4 gph at 100-150 psi, or 3 gph at 100-200 psi); interrupted ignition 15-second pre-purge primary control; 115 volt, 1/7 hp, 3450 rpm PSC (permanent split capacitor) motor; gasketing in housing provides increased static pressure; solid-state electronic igniter; requires 70° or 80° solid or hollow nozzle
12010	AF44YB	AIR TUBE COMBINATION (†) 4-1/2" x 4" O.D., .85 - 1.65 gph
2616	AF65XN	Same as above, but 6-5/8" x 4" O.D. and .75 - 1.25 gph
2617	AF72XN	Same as above, but 7-1/4" x 4" O.D. and .75 - 1.25 gph
2618	AF72XO	Same as above, but 7-1/4" x 4" O.D. and 1.10 - 2.00 gph
2619	AF104YB	Same as above, but 10-1/2" x 4" O.D. and .85 - 1.65 gph
2622	5432	MOUNTING FLANGE , adjustable, for all models except "AT"

BURNER PARTS & ACCESSORIES

666870	2999U	BLOWER WHEEL , 4-1/4" x 2-7/16", for Weil-McLain WGO, Miller CMF
12284	2459U	BLOWER WHEEL , 4-1/2" x 3-7/16", for AF burner
2671	571801	BULKHEAD FITTING KIT (A) , for AF burner
2669	3666	BULKHEAD FITTING LOCKNUT , for #571801
2655	360000	BURNER HEAD , (F0) for AR and SR burners, .75 gph range
2656	360003	Same as above, but (F3) for AF burner; .75 - 1.25 gph range
2657	360006	Same as above, but (F6) for AF burner; .85 - 1.65 gph range
12011	5628	CONNECTOR TUBE ASSEMBLY , 9-1/2", for AF burner
2670	5636	Same as above, but 6-1/2", for A, AF, AFG burners (=Miller #660594)
163331	5669U	DELAYED OIL VALVE (Honeywell #V4046A1009) WHILE SUPPLIES LAST
24658	5780	ELECTRODE KIT , universal
59002	31653	GASKET , oil burner flange
649458	7505P152MU	GENISYS PRIMARY CONTROL , with 120V, 15-second post-purge
637995	7505P1515U	Same as above, but with 2-second post-purge
649459	52040U	GENISYS LOCKOUT ALARM

FOR ADDITIONAL PARTS & O.E.M. OIL TANK ACCESSORIES, SEE PAGE 614.1
FOR ADDITIONAL INFORMATION, VISIT THE BECKETT WEBSITE AT www.beckettcorp.com

(†) For usable length with adjustable flange, deduct 7/8"

BURNER WARRANTY NOTE: Limited 5-year warranty on Beckett manufactured or Beckett labeled components (oil burner, pump, motor, igniter); 18 month warranty on Honeywell controls.

BECKETT BURNER & OEM OIL PARTS & ACCESSORIES







ID ORDER#	MODEL#	DESCRIPTION
--------------	--------	-------------

PARTS & ACCESSORIES (continued)

616254	7505B1500U	GENISYS OIL PRIMARY CONTROL , interrupted ignition, 15-second pre-purge (=#1500U, =Bard #9022-095)
189699	51771U	IGNITION TRANSFORMER , 120V, 60 Hz, for A, AF, AFG burners
2639	2364U	MOTOR , oil burner, 1/4 hp, 3450 rpm
19322	21805U	MOTOR , 1/7 hp, 3450 rpm, PSC, for A/AF/AFG burner
2637	213U	NOZZLE ADAPTER , for AF oil burner
2624	5685	PEDESTAL , standard floor mount
733464	PF20322U	PUMP , Beckett CleanCut (=PF10322U and A2EA-6527), 120V
2641	3294164BKU	TUBE ONLY , 16-1/2", less nose cone and drawer assembly; 4" O.D. for AF burner (= #3307)

OEM OIL TANK PARTS & ACCESSORIES

	10301	4522	COMBINATION ALARM & GAUGE , 1-1/2" x 1-1/4" for vertical tank, 44"
	10305	4570	DOUBLE TAPPED BUSHINGS , 1-1/4" x 1"
	10313	4581	Same as above, but 2" x 1-1/2"
	10293	4475	DUPLEX BUSHING , 2" x 3/8" x 3/8", CI, with fittings
	10294	4476	Same as above, but 2" x 1/2" x 1/2"
	10285	4171	HINGE-TYPE FILL BOX WITH LOCK , 2"
	600264	4503	GAUGE , 1-1/2" - 2", with dual bushing
	10300	4511	KING FILL ALARM , 1-1/2" M x 1-1/4" F
	63390	4552	Same as above, but 1-1/4" M x 1-1/4" F
	10297	4504	KING OIL TANK GAUGE , 1-1/2" - 2" x 44", for horizontal tank
	10278	4022	MUSHROOM THREADED VENT CAP , 1"
	10279	4023	Same as above, but 1-1/4"
	10280	4024	Same as above, but 1-1/2"
	10281	4025	Same as above, but 2"
	10298	4495	REPAIR GLASS GAUGE TOP , with gaskets
	10276	4006	SLIP-ON VENT CAP , 3/4"-1"

**FOR ADDITIONAL INFORMATION, VISIT
THE BECKETT WEBSITE AT www.beckettcorp.com**

SUNTEC

OIL BURNER FUEL PUMPS

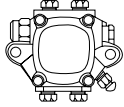

ID ORDER#	MODEL#	ROTATION/ PORT OPENING	RPM	REMARKS
9002	A1YA-7912	CW/RH	1725	1 STAGE WITH FLANGE (=A1VA-7112)
9020	A2VA-7116-B	CW/RH	3450	Same as above (=A2VA-7016 and A2VA-7116)

WARRANTY NOTE: The presence of water, rust, teflon tape or contaminants in the pump voids all manufacturer's warranties. When returning a potential warranty pump for credit, you must provide explicit detail of the nature of failure/defect. "Bad" or "won't work" is not a satisfactory explanation and credit will be denied. Always identify pump rotation by reading rotation with pump shaft pointing toward you.

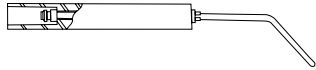
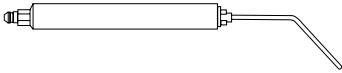

WESTWOOD – CROWN ELECTRODES

	ID ORDER#	WESTWOOD (†) MODEL#	CROWN (†) MODEL#	PORCELAIN		ELECTRODE	
				DIA (IN)	LGTH (IN)	DIA (IN)	LGTH (IN)
STANDARD ELECTRODE (PAIRS)	1093	E5-1M4	101-4	7/16"	4"	1/8"	3"
	1096	E5-1M4-1/2	101-4-1/2	7/16"	4-1/2"	1/8"	3"
	1097	E5-1M5	101-5	7/16"	5"	1/8"	3"
	1099 *	E5-1M6	101-6	7/16"	6"	1/8"	3"
	1101	E5-3M4	102-4	9/16"	4"	1/8"	3"
	1102	E5-3M4-1/2	102-4-1/2	9/16"	4-1/2"	1/8"	3"
	1104	E5-3M5	102-5	9/16"	5"	1/8"	3"
	1106	E5-3M5-1/2	102-5-1/2	9/16"	5-1/2"	1/8"	3"
	1108 *	E5-3M6	102-6	9/16"	6"	1/8"	3"
	1110 *	E5-3F4	103-4	9/16"	4"	1/8"	3"
	1113 *	E5-3F5	103-5	9/16"	5"	1/8"	3"
	1117	E5-3F6	103-6	9/16"	6"	1/8"	3"
	1118	E5-4M4	104-4	1/2"	4"	1/8"	3"
	1120	E5-4M4-1/2	104-4-1/2	1/2"	4-1/2"	1/8"	3"
	1122	E5-4M5	104-5	1/2"	5"	1/8"	3"
	1124 *	--	104-5-1/2	1/2"	5-1/2"	1/8"	3"
	1125	E5-4M6	104-6	1/2"	6"	1/8"	3"
	1127	E5-2M4	105-4	9/16"	4"	3/32"	3"
	1129 *	E5-2M4-1/2	105-4-1/2	9/16"	4-1/2"	3/32"	3"
	1131	E5-2M5	105-5	9/16"	5"	3/32"	3"
	1133 *	E5-2M5-1/2	105-5-1/2	9/16"	5-1/2"	3/32"	3"
	1134 *	E5-2M6	105-6	9/16"	6"	3/32"	3"
	1136 *	E5-2F4	106-4	9/16"	4"	3/32"	3"
	1138 *	E5-2F4-1/2	106-4-1/2	9/16"	4-1/2"	3/32"	3"
	1139 *	E5-2F5	106-5	9/16"	5"	3/32"	3"
	1141 *	E5-2F6	106-6	9/16"	6"	3/32"	3"
	1142 *	E5-5M4	109-4	1/2"	4"	3/32"	3"
	1147 *	E5-5M5	109-5	1/2"	5"	3/32"	3"
	1148 *	E5-5M6	109-6	1/2"	6"	3/32"	3"
SPECIAL ELECTRODES							
Auto Burner Corp. (ABC)	1155	E5-146	CA-56	9/16"	4"	--	1-5/8"
Sunray Burner (ABC)	1157 *	E5-144H	CA-70	7/16"	3-5/8"	--	1-3/8"
Blue Ray	10818	--	CB-51	7/16"	3-1/4"	--	1-1/2"
R.W. Beckett	1159	E5-151E	CB-3	9/16"	3-1/4"	--	1-3/8"
R.W. Beckett	1160	E5-151	CB-6	9/16"	5"	--	1-1/4"
Bettendorf (Lennox)	1162	E5-157	CB-22	9/16"	6"	--	1-3/8"
Iron Fireman	1178	E5-363	CI-18	9/16"	6"	--	3/4"
Iron Fireman	1181 *	--	CI-26	9/16"	5"	--	2-7/8"
S.T. Johnson	1183 *	E5-371	CJ-2	.615"	3-1/8"	--	1-7/16"
Shell Head	1188 *	--	CS-10	9/16"	5"	--	1-21/32"
Wayne	1206	E5-604	CW-9	1/2"	4"	--	1-7/8"
Wayne	1209	E5-605	CW-10	1/2"	4"	--	1-7/8"
Wayne	1210	E5-606	CW-11	1/2"	4"	--	1-1/4"

* = SPECIAL ORDER ITEM

(†) Source may vary.

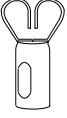
WESTWOOD – CROWN IGNITION COMPONENTS

	ID ORDER#	WESTWOOD (†) MODEL#	CROWN (†) MODEL#	DESCRIPTION	* = SPECIAL ORDER ITEM
 IT200	1221 *	--	IT200	CAGE	
	1223	E9-SS	IT201	SPRING	
	1225 *	E9-ACT	IT204	ANGLE CAGE	
	1227 *	E9-ASS	IT205	ANGLE SPRING	
	1228 *	E9-SF	IT206	STUD FERRULE	
	1230	E9-BS-6-32	IT207-6	6-32 HEX BASE STUD	
	1231 *	E9-BS-10-32	IT207-10	10-32 HEX BASE STUD	
	1233 *	E9-HS-10-32	IT208-10	10-32 HOLLOW THREADED STUD	
	1234 *	E9-ET	IT209	EYELET	
	1235 *	E9-CC-1	IT215C	CAGE/CAGE	
 IT221	1236	E9-SS-TS	IT217	3/8 SPRING/THREADED STUD	
	1238	E9-SS-BS	IT219	8-32 SPRING/HEX BASE	
	1239	E9-RC-5	IT221	CAGE/BUSS BAR CLIP	
	1240	E9-RP-6	IT222	SPRING/BUSS BAR CLIP	
	1242	E9-AL-10	IT230	<i>Same as above</i>	
	1243	E9-TS-10	IT231S	BINDING POST/SPRING	
	1247	E9-B-10	IT235	10-32 CONTACT POST	
	1249 *	E9-BC-11	IT281	CAGE WITH BRASS POST	
	1251 *	E9-ITN-1032	IT290	SMALL INSULATED NUT	
	 ITA-500	1254 *	--	ITA500	STEEL BUSHING, 7/16" ID x 9/16" OD
1256 *		--	ITA501	<i>Same as above, but 7/16" ID x 1/2" OD</i>	
1264		E9-686BAR	ITA516	BUSS BAR	

(†) Source may vary.

WESTWOOD – CROWN

IGNITION COMPONENTS & COUPLINGS

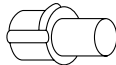
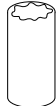
	ID ORDER#	WESTWOOD (†) MODEL#	CROWN (†) MODEL#	DESCRIPTION
IGNITION COMPONENTS				
	1269	E9-54	ITM-243 (#41805)	TERMINAL KIT , contains: plastic box with #IT215, #IT221, #IT223, #IT224, #IT225, #IT226, #IT229, #IT230, #IT231, #IT233, #IT234 and #IT235
	1220	E60-100	GTO-15 (#41652)	HIGH VOLTAGE IGNITION CABLE , .275 OD with #14 stranded copper conductor in plastic insulator, 100' per roll
	1211	E9-TYPE-ET	"E" (#40315)	1/8 ROUND BUSS BAR , 12" length
	1212	E9-TYPE-F	"F" (#40320)	FLAT BUSS BAR , 12" length
TOOLS				
	1208	T100-220	CSG-297 (#40445)	ELECTRODE GAUGE , for setting proper oil burner ignition gap
	1266	T100-230	ITB-266 (#40430)	IGNITOR TIP BENDING TOOL , set of 2
OIL BURNER COUPLINGS				
	1276	--	KK-120 (#41215)	FLEXIBLE OIL BURNER COUPLING , 5-1/2" cut-to-length with 5/16", 3/8", 7/16", 5/8" and (2) 1/2" shaft bushings (= Miller #700029000 and #660596)
T&P GAUGE				
	4236	H25-15	PT 1088	T&P GAUGE , 2-1/2" face, 70°F-320°F and 75 psi
	4235	H25-16	PT 1088	Same as above, but 60°F-320°F
	4234	H25-17	PT 1088	Same as above, but 4-1/4" face, 60°F-260°F and 50 psi
	4238	H25-18	PT 1088	Same as above, but 75 psi

(†) Source may vary.

WESTWOOD COMBUSTION CHAMBER LINER

ID ORDER#	MODEL#	DESCRIPTION
191341	S70-9	WET-PACK COMBUSTION CHAMBER LINER , pre-shaped, .50-.75 gph, 9" OD x 12" high
197609	S70-10	<i>Same as above</i> , .85-1.00 gph, 10" OD x 12" high
2629	S70-12	<i>Same as above</i> , 1.35-1.50 gph, 12" OD x 12" high
2632	S70-30	WET-PACK COMBUSTION CHAMBER FLAT LINER SHEET , 1.25 gph, 14" (W) x 48" (L) x 3/8" (D) (#1)

FOR WESTWOOD THERALTIMETERS, SEE 400 SECTION

DELAVAN OIL BURNER NOZZLES (SOLID)



IDENTIFICATION KEY

All nozzles carry a "type" designation such as "NS", "SS", "AR", etc. This identifies the type of pattern. The equivalencies of these letters are listed as follows:

SOLID = B, R, P, ES
SEMI-SOLID = W, Q, PLP, AR, SS
HOLLOW = H, NS, PL, A, PH

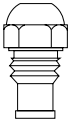
	ID ORDER#	GPH	DEGREE		ID ORDER#	GPH	DEGREE
SOLID NOZZLES				SOLID NOZZLES (continued)			
	13494	.50	60°	13509	1.65	60°	
	23874	.50	80°	13519	1.65	80°	
	13495	.60	60°	13521 *	1.75	60°	
	13496	.60	80°	13522	1.75	70°	
	24623	.60	90°	13523	1.75	90°	
	35390	.65	70°	13524	2.00	45°	
	76040	.65	80°	13525	2.00	60°	
				13526	2.00	70°	
	13497	.75	60°	13527	2.00	80°	
	15284	.75	70°	13528	2.00	90°	
	13498	.75	80°				
	26768	.75	90°	36960	2.25	80°	
	230088	.85	45°	13530	2.50	45°	
	43957	.85	70°	13531	2.50	60°	
	42986	.85	80°	13532	2.50	80°	
	13499	.90	80°	13536	3.00	60°	
	78201	1.00	60°	13542 *	4.50	80°	
	13500	1.00	70°				
	13501	1.00	80°	13549	6.50	60°	
	134106	1.00	90°				
78202	1.10	60°	13552	8.00	60°		
15285	1.10	70°					
30161	1.10	80°					
			* = SPECIAL ORDER ITEM				
13502	1.20	60°					
13503	1.25	60°					
13504	1.25	70°					
15590	1.25	80°					
13506 *	1.50	60°					
13507	1.50	70°					
15555	1.50	80°					

GAR-BER FILTERS LINE #5930

- 500 square inches of filter area (10X the General 1A25)
- Resin-coated filter paper won't pull through under high vacuum
- Wall-mounting bracket included
- 3/8" NPT inlet and outlet
- 45 GPH flow rate



ID ORDER#	MODEL#	DESCRIPTION	CTN QTY
40534 *	11BV-R	GAR-BER FILTER , complete with wall bracket	12
40535	#R	GAR-BER REPLACEMENT CARTRIDGE , cartridge only	12

CAUTION: When used on a 2-line system, the #R cartridge may have to be changed frequently unless a "tiger loop" recirculating system is used.

GENERAL FILTERS LINE #5900

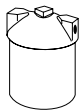

4853	1A-25A	STANDARD MODEL , with Biogasket® and epoxy-coated galvanized steel filter bowl; 5-1/16" high x 3-5/8" diameter; firing rate of 10 gph #2 oil (for small to average homes with gravity or pressure type burners); compatible with bio-fuel blends up thru B100	12
625718 *	2A-700B	MASTER MODEL , 6-5/32" high x 4-3/8" diameter; firing rate of 25 gpm no. 2 oil (for average and large homes); with Biogasket and epoxy-coated galvanized steel filter bowl; compatible with bio-fuel blends up thru B100	12

NOTE: Upgrade kits are available to convert "A" models to "B" bio-fuel models.

WESTWOOD LINE #4560

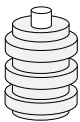

5639	F15-36	OIL FILTER REFILL , classic felt, for use in General 1A-25A; Unifilter 77; Westwood F10, F12, F15, F20 and F25; Sid Harvey (Mitco) 264 and 254F	36
5640	F35-12	OIL FILTER REFILL , classic felt, for use in General 2A-700A; Unifilter 99; Westwood F30, F32, F35, F65 and F70; Sid Harvey (Mitco) 265	12

* = SPECIAL ORDER ITEM

700 SECTION

Tools — Fasteners — Hangers

700 SECTION INDEX

Amtrol	708	Power-Strut (ASC)	704-704.1
	(also see 400 section)	Richard Specialty Company	711
Anvil (ASC)	705	Ridgid	703
	(also see 100 section)	Sioux Chief	708.2
Basset	707-707.1		(also see 100 and 200 sections)
B-Line	708	Supco	see 500 section
Bostitch	see 500 section	Tape	710
Bruco	708	UEi Test Instruments	701
Dwyer Instruments	711	Wagner Products Corp.	708.2
EMC (Ebinger)	706	Yellow Jacket	700-700.1
ESP (Tommy Gun Sprayer)	see 500 section		
General Chain & Mfg. Corp.	708.1		
Jones-Stephens	708.1		
	(also see 100 section)		
Malco	702-702.3		
Maxipro	see 100 section		
Mechanic's Wire	see 500 section		
Mill-Rose	709-710		
	(also see 300 section)		
Oatey	708.1		
	(also see 100, 300 and 400 sections)		

YELLOW JACKET HVAC SERVICE TOOLS



ID ORDER#	MODEL#	DESCRIPTION
778493	42035	MANIFOLD ONLY—3-VALVE , add for hose set, for R32, R454B and R410A
739414	42001	MANIFOLD ONLY—3-VALVE , add for hose set, for R22, R404A and R410A
778494	49974	MANIFOLD ONLY—TITAN 4-VALVE TEST AND CHARGING , add for hose set, for R32, R454B and R410A
739421	49963	MANIFOLD ONLY—TITAN 4-VALVE TEST AND CHARGING , add for hose set, for R22, R404A and R410A
739398	40870	MANIFOLD KIT—P51-870 TITAN DIGITAL WITH WIRED SENSORS , for R22, R404A and R410A
746461	40877	Same as above, but <u>with Y-Jack wireless sensors</u>
739415	29985	MANIFOLD HOSE , 60", set of 3, <u>with compact ball valve ends</u> (yellow-blue-red), for R22, R404A and R410A
741806	22985	Same as above, but <u>with SealRight low loss anti-blowback fitting at one end</u>
739423	18160	BBA-60 YELLOW CHARGING HOSE , 60", for 4-valve manifold, for R22, R404A and R410A
778495	93870	BULLET VACUUM PUMP , 7 CFM, for R32, R454B, and R410A
739399	93600	BULLET VACUUM PUMP , 7 CFM, for R22, R404A and R410A
739428	68862	CHARGING SCALE WITH BAG (DIGITAL) , 220#, for R22, R404A and R410A
739410	69020	OMNI VACUUM GAUGE (DIGITAL) (microgauge), for R22, R404A and R410A
719314	60325	RATCHET HAND TUBE BENDER KIT , for R22, R404A and R410A
762135	95780	REFRIGERANT RECOVERY MACHINE , Turbocover, for R22, R404A and R410A
739438	60648	TORQUE WRENCH (DIGITAL) , for R22, R404A and R410A
739429	93887	VACUUM PUMP HOSE KIT , for R22, R404A and R410A

FOR ADDITIONAL INFORMATION, VISIT THE
YELLOW JACKET WEBSITE AT www.yellowjacket.com

YELLOW JACKET ACCESSORIES



ID ORDER#	MODEL#	DESCRIPTION
778497	19180	ADAPTER , 5/16" female flare x 1/4" male flare, for R32, R454B and R410A
468310	19173	ADAPTER , 5/16" female flare x 1/4" male flare, for R22, R404A and R410A
742119	60100	BLADE , for #60101 and #60102 cutters
739444	60072	Same as above, but for #60121 cutter
739433	49138	COMPOUND GAUGE—BLUE , 3-1/8", 0-800 PSI
739436	60121	CUTTER (MINI) , for 1/4" to 7/8" OD
739434	60101	CUTTER (SMALL) , for 1/8" to 1-1/8" OD
739443	60106	CUTTER REPLACEMENT WHEEL , for #60101 cutter
739426	78060	GAS PRESSURE TEST KIT , for NG or LP gas, 0-35" WC
715901	19020	GASKET , 10/pkg
739431	49137	PRESSURE GAUGE—RED , 3-1/8", 0-800 PSI
739411	19037	SEALRIGHT O-RINGS , 10/pkg
586216	19109	SEALRIGHT QUICK COUPLER , 1/4" straight x 1/4" male flare
746449	19041	SEALRIGHT REBUILD KIT , 1/4"
739417	19306	VALVE CORES , 6/pkg
756321	19305	Same as above, but for 10/pkg
756319	18975	VALVE CORE REMOVING TOOL—1/4"

FOR ADDITIONAL INFORMATION, VISIT THE
YELLOW JACKET WEBSITE AT www.yellowjacket.com



ID ORDER#	MODEL#	DESCRIPTION
744232	C161	<p>COMBUSTION ANALYZER WITH DIRECT CO₂ MEASUREMENT, features:</p> <ul style="list-style-type: none"> - flue gas combustion analyzer - flue probe with cone and hose - USB charging cable - quick start guide - (3) AA rechargeable batteries - 6 line display - EOS technology - Heat exchanger test function - High altitude compensation - Calculates O₂, efficiency (net or gross), excess air, CO/CO₂ ratio and differential temperature - NOx filtered - Water trap indication - Measures CO, CO₂, flue and ambient temperature - 8 preprogrammed fuels - IR printer port - Low flow detection - Auto-purge at shut-down - Protective rubber boot with magnet - 30 memory positions - 1 year limited warranty
738859	EM152	<p>DIGITAL MANOMETER—DUAL DIFFERENTIAL, features:</p> <ul style="list-style-type: none"> - Differential pressure - Range of -60° to 60°F in H₂O - Dual input differential measurement up to 80.27" of water column within range - Measures in 11 scales - Magnetic mount - Auto ranging - Backlit display - Data hold - Max/min - Zero button - 1 year limited warranty
745239	PDT660	<p>FOLDING DIGITAL POCKET THERMOMETER, features:</p> <ul style="list-style-type: none"> - Battery - Backlit display - Folding temperature probe - Reads open or closed - Min/Max - Auto power off - -58° to 572°F - Designed for in-duct measurement - Probe cover functions as an extension for hard-to-reach areas - Approximate 1 hour auto power off - 1 year limited warranty
762630	DTH35	<p>POCKET PSYCHROMETER, features:</p> <ul style="list-style-type: none"> - Battery - Temperature -4° to 122°F - Relative humidity 0.1% to 99.9% - Wet bulb 5° to 121.8°F - Dew point -4° to 121.8°F - Enthalpy -1 to 1.25 BTU/LB - Minimum/maximum data hold

FOR ADDITIONAL INFORMATION, VISIT THE UEi WEBSITE AT www.ueitest.com



	ID ORDER#	MODEL#	DESCRIPTION
	746566	M12N	ALUMINUM-HANDLED SNIP , for straight cuts, 12" overall length with 3" cut
	44938	M14N	Same as above, but 14" overall length and 3-1/4" cut
	445701	AV1	AVIATION SNIP , left hand cut, red grips
	445704	AV2	Same as above, right hand cut, green grips
	445705	AV3	Same as above, combination right-left hand cut, straight cutting, yellow grips
	445706	AV6	AVIATION SNIP OFFSET , offset cutting; cuts LH angles, RH circles & straight; compound leverage
	445707	AV7	Same as above, but cuts RH angles, LH circles & straight
		8687	DS1
	427475	DS2	Same as above, but with offset handle to eliminate knuckle contact
	202819	12F	FOLDING TOOL , 12" length with 3/8" and 1" depths
	468332	18F	Same as above, but 18" length
	235658	24F	Same as above, but 24" length
	657517	C5R	HAND CRIMPER , with 1-1/4" throat
	657518	N1R	HAND NOTCHER , 13/16" x 30"
	657519	S2R	HAND SEAMER , 3-1/4" wide with 1/4" - 1-1/4" adjustable depth
	691394	S3R	HAND SEAMER—OFFSET , 3-1/4" wide with 1/4" - 1-1/4" adjustable depth
	657515	S6R	HAND SEAMER , 6" wide with 1/4" - 1-1/4" adjustable depth
	8622	2DH	PIPE AND DUCT HOLDER , with 2-8" clamps & chain
	8675	CB	REPLACEMENT BIT , for HC1 cutter
	226634	TS1RB	REPLACEMENT BLADE , for TS1 Turbo Shear
	16040	HC1B	REPLACEMENT PIVOT POINT , for HC1 cutter
	8663	A3	SCRATCH AWL , 3/8" x 7-1/2"
	8680	HC1	SHEET METAL CUTTER , 2" to 20" hole diameter; for up to 20 gauge, uses standard 1/4" drill
	50120	A60	SHEET METAL SCRIBER
	657516	SL1R	SNAP LOCK PUNCH , 3/8" throat depth
	226528	TS1	TURBO SHEAR™ , 20 gauge capacity, attaches to a minimum 12V cordless or A/C electric drill

FOR ADDITIONAL INFORMATION, VISIT THE MALCO WEBSITE AT www.malcoproducts.com

SEPTEMBER 2024

Line #8170

MALCO DUCTBOARD TOOLS

702.1



ID			
ORDER#	MODEL#	DESCRIPTION	
209156	FDC3	MULTI-PURPOSE FLEX DUCT TOOL , combination cutter and tensioning tool, 11-7/8" L	
8553	TY34	NYLON STRAP , adjustable, 36", package of 25	
15703	TY48	<i>Same as above</i> , but 48"	
36455	TY4G	TENSIONING TOOL , for nylon straps	

FOR ADDITIONAL INFORMATION, VISIT THE MALCO WEBSITE AT www.malcoproducts.com

MALCO

MISCELLANEOUS TOOLS



ID ORDER#	MODEL#	DESCRIPTION
202185	BHE6	BIT HOLDER EXTENSION , 6"
753768	CG12	CAULK GUN , 1/10 gallon
8722	FJ60S	DRILL SET, 60 PIECE , wire size from 1 - 60 with sizing index
8726	FJ6180	DRILL SET, 20 PIECE (†) , wire size from 61 - 80 with index & pin vise, in box, ideal for orifices
8832	MSH14	HEX DRIVER , magnetic, for 1/4" head Zip-in & "A" self-tap screws
8833	MSH516	Same as above, but for 5/16" head
718368	MSMC	HEX DRIVER , 2" overall length, reversible, magnetic, dual sided, 1/4" and 5/16"
756046	MSHLC	Same as above, but 2-3/4" long
740476	MSHXC	Same as above, but 6" long
781389	MSHCST	HEX DRIVER—SAWTOOTH , 2" overall length, reversible, magnetic, dual sided, 1/4" and 5/16"
335604	HHD1	HEX DRIVER—LONG , magnetic, for 1/4" head screws
145095	HHD2	Same as above, but for 5/16" head
753769	RD6	HEX DRIVER—6-IN-1 , reversible, 1/4" and 5/16" hex opening nut driver with 3/16" and 9/32" slotted head bit and #1 and #2 Phillips head bit
8829	W6	HEX KEY SET , 6" set, 9 sizes, 5/64" to 1/4"
753772	WT9SG	HEX KEY SET—T-HANDLE , 9" long, 8 sizes, 3/32" to 1/4"
202183	SH3V	SETTING HAMMER , 11-3/4", with vinyl grip
55254	DE18	SHEET METAL DRILL BITS , 1/8" and double ended
753770	T425M	TAPE MEASURE—MAGNETIC , 25'
753771	TBP33	TOOL BACKPACK , 33 pockets and pouches
207312	TC400	TUBE SLICER , produces cuts in ABS, PVC, rubber and fabric-reinforced hose up to 1" ID, rigid nylon handle, stainless steel cutting blade is resharpenable and replaceable
765308	RRW316	WRENCH INSERT , 3/16"
732694	RRW516	Same as above, but 5/16"

FOR ADDITIONAL INFORMATION, VISIT THE MALCO WEBSITE AT www.malcoproducts.com

MALCO

BLADES, SCREWS & DAMPERS



ID ORDER#	MODEL#	BLADE TYPE	TEETH PER INCH	LENGTH	BOX QUANTITY	
RECIPROCATING SAW BLADES ("SAWZALL")						
	208372	4KH7	Bi-Metal	6	6"	5
	208381	4KH6	Bi-Metal	5/7	6"	5
	208386	12KH8	Bi-Metal	5/7	12"	5
	208373	4TF18	Bi-Metal	18	6"	5
	208385	8KH7	Bi-Metal	5/7	9"	5
	739390	9MC10	Bi-Metal	10/14	9"	5

ID ORDER#	MODEL#	SCREW SIZE	HEAD LENGTH	DRIVER (HEAD) SIZE	MATERIAL THICKNESS	PKG QTY
-----------	--------	------------	-------------	--------------------	--------------------	---------

SELF-TAPPING SCREWS

BIT-TIP



713552	BT131G	#2	1/2"	1/4"	.035 - .10	100
8540	BT231G	#2	1/2"	1/4"	.035 - .10	100
613681	BT231T	#2	1/2"	1/4"	.035 - .10	1000
8549	BT233G	#2	1/2"	1/4"	.035 - .10	100
725692	BT233T	#2	1/2"	1/4"	.035 - .10	500
182368	BT143T	#3	1/2"	5/16"	.035 - .10	500

DRILL-IN



43218	HW10x1-1/2T	#10	1-1/2	5/16"	--	250
39888	HW10x2T	#10	2	5/16"	--	250

ZIP-IN SLOTTED HEX



8469	HW8x1/2ZG	#8	1/2	1/4"	--	100
8470	HW8x1/2ZT	#8	1/2	1/4"	--	1000
67476	HW8x1/2Z	#8	1/2	1/4"	--	12,000
753785	HW8x34Z	#8	3/4	1/4"	--	10,000
753786	HW8x34ZP	#8	3/4	1/4"	--	5,000
8472	HW8x1ZG	#8	1	1/4"	--	100
16041	HW8x1-1/2ZT	#8	1-1/2	1/4"	--	250
444515	HW8x2ZG	#8	2	1/4"	--	50
8473	HW10x3/4ZG	#10	3/4	5/16"	--	100
8474	HW10x3/4ZT	#10	3/4	5/16"	--	1000
43217	HW10x1ZT	#10	1	5/16"	--	500

FOR PIN RIVETS, SEE 500 SECTION

ID ORDER#	MODEL#	DESCRIPTION
-----------	--------	-------------



DAMPERS



51277	D6AST	SINGLE BEARING DAMPER , galvanized with handle, 6"
51311	D7HTAST	DOUBLE BEARING DAMPER , galvanized with handle, 7"
51314	D8HTAST	Same as above, but 8"

FOR ADDITIONAL INFORMATION, VISIT THE MALCO WEBSITE AT www.malcoproducts.com



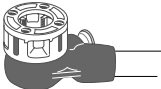
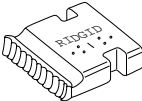

	ID ORDER#	MODEL#	SIZE	DESCRIPTION
HAND TOOLS				
	8284	E47	3/4"	FLARING TOOL , hammer type
	8285	E52	1"	Same as above
	8050	104	15/16" O.D.	MIDGET TUBING CUTTER , with E-3469 wheel
	8002	1017	3/8"-1-1/4"	TELESCOPING BASIN WRENCH , 10" to 17"
	8044	15HD	3/16"-1"-1/8" O.D.	TUBING CUTTER , heavy duty, with F-158 thin wheel
	8052	150	1/8" -1-1/8" O.D.	Same as above, but with E-3469 thin wheel
	8055	205	1/4" - 2-3/8" O.D.	TUBING CUTTER , ratcheted enclosed feed
	8041	202	1/8"-2"	WIDE ROLL PIPE CUTTER , for machine use (replacement wheel = F-3, F-3S or F-19)
DIE HEADS				
	8257	37390	1/2"	NPT DIE HEAD , for #12R NPT exposed ratchet drop, head pipe threader
	8261	37395	3/4"	Same as above
	8263	37400	1"	Same as above
	8265	37410	1-1/2"	Same as above
	8266	37415	2"	Same as above
	8279	30118	--	RATCHET AND HANDLE , for #12R
	DIES			
	8270	37825	1/2"	NPT DIES ONLY , RH, allow steel, for OR, OOR, 1R, 11R, 111R, 30A and 31A pipe threaders
	8271	37830	3/4"	Same as above
	8272	37835	1"	Same as above
	8273	37840	1-1/4"	Same as above
	8275	37845	1-1/2"	Same as above
	8276	37850	2"	Same as above
	8325	47745	1/2"-3/4"	NPT UNIVERSAL PIPE DIES , RH thread
	8326	47750	1"-2"	Same as above

FOR ADDITIONAL INFORMATION, VISIT THE RIDGID WEBSITE AT: www.ridgid.com

POWER-STRUT (ASC) CHANNELS, FASTENERS & FITTINGS

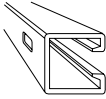

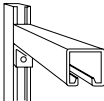
	ID ORDER#	MODEL#	FINISH	SIZE	DESCRIPTION	* = SPECIAL ORDER ITEM
CHANNEL						
	80025	AS200EH-10'	Green	1-5/8" x 1-5/8"	FABRICATED CHANNEL , with 1-1/8" x 9/16" elongated holes on 2" centers, 12 gauge	
FASTENERS						
	80032	ASRS	Galvanized	3/8"	CLAMPING NUT WITH REGULAR SPRING , 16 threads	
	80033	ASRS	Galvanized	1/2"	Same as above, but 13 threads	
	80034	AS6024	Galvanized	3/8" x 1"	HEX HEAD CAP SCREW	
	80039	AS6024	Galvanized	3/8" x 1-1/2"	Same as above	
	80040	AS6024	Galvanized	1/2" x 1"	Same as above	
	80041	AS6024	Galvanized	1/2" x 1-1/2"	Same as above	
	80990	AS6024	Galvanized	1/2" x 1-3/4"	Same as above	
	80988	ASTG	Galvanized	3/8"	TOP GRIP NUT WITH SPRING ON TOP , 16 threads, for all 1-5/8" channel except AS500 and AS520	
	80989 *	ASTG	Galvanized	1/2"	Same as above, but 13 threads	
FITTINGS						
	80996	AS604	Green	--	CORNER ANGLE , 2-hole	
	80997	AS606	Green	--	Same as above, but 3-hole	
	80998	AS607	Green	--	Same as above, but 4-hole	
	80995	AS603	Green	--	END ANGLE , 2-hole	
	80993	AS601	Green	--	SPLICE PLATE , 2-hole	
	80994	AS602	Green	--	Same as above, but 3-hole	
	80043	AS619	Green	3/8" (rod size)	SQUARE WASHER , 1-5/8" x 1-5/8"	
	80044	AS619	Green	1/2" (rod size)	Same as above	

FOR ADDITIONAL INFORMATION, VISIT THE ANVIL (ASC) WEBSITE AT www.asc-es.com

POWER-STRUT (ASC) CLAMPS



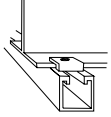





ID ORDER#	MODEL#	FINISH	SIZE	DESCRIPTION	* = SPECIAL ORDER ITEM
CLAMPS					
	80999	AS686	Green	--	BEAM CLAMP , for use with PS6024 1/2" x 1-3/4" hex head cap screw
	81001	AS1100AS	Galvanized	3/8" IP	PIPE CLAMP , <u>galvanized</u>
	81002	AS1100AS	Galvanized	1/2" IP	Same as above
	81003	AS1100AS	Galvanized	3/4" IP	Same as above
	81004	AS1100AS	Galvanized	1" IP	Same as above
	81005	AS1100AS	Galvanized	1-1/4" IP	Same as above
	81006	AS1100AS	Galvanized	1-1/2" IP	Same as above
	81007	AS1100AS	Galvanized	2" IP	Same as above
	121261 *	AS1100AS	Galvanized	2-1/2" IP	Same as above
	81008	AS1100AS	Galvanized	3" IP	Same as above
	182106 *	AS1100AS	Galvanized	4" IP	Same as above
	82223	AS1200AS	Copper	5/8" OD	PIPE CLAMP , <u>copper</u>
	82224	AS1200AS	Copper	7/8" OD	Same as above
	82225	AS1200AS	Copper	1-1/8" OD	Same as above
	82339	AS1200AS	Copper	1-3/8" OD	Same as above
	82342	AS1200AS	Copper	1-5/8" OD	Same as above
	82343	AS1200AS	Copper	2-1/8" OD	Same as above
	82344 *	AS1200AS	Copper	2-5/8" OD	Same as above
	82345 *	AS1200AS	Copper	3-1/8" OD	Same as above
	82550	P2041	--	1/2"	STRUT CLAMP , plastic, for channel bar
	82551	P2042	--	3/4"	Same as above
	82552	P2043	--	1"	Same as above
	82553	P2044	--	1-1/4"	Same as above
	81000	AS2651-T1	Galvanized	--	U-BOLT BEAM CLAMP , for PS200 and PS500

FOR ADDITIONAL INFORMATION, VISIT THE ANVIL (ASC) WEBSITE AT www.asc-es.com

ANVIL (ASC)

HANGERS, FASTENERS and THREADED ROD

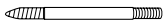

	(ID) ORDER#	MODEL#	SIZE	DESCRIPTION	CTN QTY
	5944	260	1-1/2"	ADJUSTABLE CLEVIS HANGER , heavy duty carbon steel	100
	5945	260	2"	<i>Same as above</i>	100
	5946	260	2-1/2"	<i>Same as above</i>	50
	5947	260	3"	<i>Same as above</i>	50
	5948	260	4"	<i>Same as above</i>	25
	5949	260	6"	<i>Same as above</i>	10
	444549	69	1/2", 3/4", 1"	ADJUSTABLE SWIVEL RING , carbon steel, NFPA standard trap	100
	5901	69	1-1/4"	<i>Same as above</i>	100
	5902	69	1-1/2"	<i>Same as above</i>	100
	5903	69	2"	<i>Same as above</i>	100
	15456	69	2-1/2"	<i>Same as above</i>	50
	15457	69	3"	<i>Same as above</i>	50
	5906	69	4"	<i>Same as above</i>	50
	5907	69	6"	<i>Same as above</i>	20
	446659	CT69	1/2", 3/4", 1", 1-1/4"	SWIVEL RING , copper plated	100
	5912	CT69	1-1/2"	<i>Same as above</i>	100
	5913	CT69	2"	<i>Same as above</i>	100
	129108	CT69	2-1/2"	<i>Same as above</i>	50
	197219	CT69	3"	<i>Same as above</i>	50
	5915	92	3/8"	"C" CLAMP , with lock nut for 3/8" rod	50
	5916	92	1/2"	<i>Same as above</i> , but for 1/2" rod	20
	5940	157	1/2"	EXTENSION PIECE , malleable iron	35
	5935	136	3/8"	ROD COUPLING , straight	75
	5936	136	1/2"	<i>Same as above</i> , but 1/2"	40
	195555	--	3/8" - 16"	THREADED ROD — 10', galvanized	
	195556	--	1/2" - 13"	<i>Same as above</i>	
	5937	142	3/8" x 3-1/2"	WOOD SCREW x THREADED ROD BOLT	100

EMC HANGERS & ACCESSORIES



ID ORDER#	MODEL #	SIZE	DESCRIPTION
--------------	---------	------	-------------

HANGERS

POWER'S FASTENERS VERTIGO ROD HANGING SYSTEM, self-drilling screw-style hanger used for anchoring into wood and steel substrates, suitable for solid base materials, simple insulation—fast, user-friendly way to hang rod overhead; for 3/8" threaded rod applications, UL and FM (factory manual) approved; hangers are packed 100 per box but may be sold individually

681195	7158	1/4" x 20" x 1"	HANGER (VERTICAL) , for steel
600433	7165	1/4" x 2"	HANGER (VERTICAL) , for wood
600434	7167	1/4" x 3"	<i>Same as above</i>
587312	7184	1/4"-20 x 1"	HANGER (SIDE) , for steel
757319	7170	1/4" x 2"	HANGER (SIDE) , for wood



ACCESSORIES

720006	08620 50R	1/2"	NIPPLE TRAY
720007	08621 75R	3/4"	<i>Same as above</i>
748191	99514	3/4"	STRAP , 1-hole rigid, zinc-plated steel with lock-in feature, ribbed for extra strength, used for linesets, vinyl or plastic drain line and CSST tubing, 100/box
748192	99515	1"	<i>Same as above</i>
748193	99516	1-1/4"	<i>Same as above</i> , but 25/box
587316	7187	--	UNIVERSAL SOCKET DRIVER , for wood and steel

**FOR ADDITIONAL INFORMATION, VISIT THE EMC WEBSITE AT
www.ebinger-mfg.com or www.powers.com**

BASSET HANGERS & ACCESSORIES

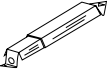
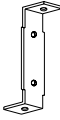
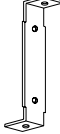

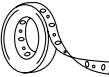
	ID ORDER#	MODEL#	SIZE	DESCRIPTION	CTN QTY
	6794	A-125	12" - 19"	ADJUSTABLE DUCT HANGER , galvanized, spans between joists	25
	544501	ATS-125	12" - 19"	ADJUSTABLE DUCT HANGER , galvanized, with preloaded screws for use in supporting duct work or piping when working with "TJI" floor; screw tabs allow for easy installation into center section of "I" joist (for use where a screw tab is preferred to self-nailing)	25
	544502	ETS-125	19" - 26"	<i>Same as above</i> , but extra long	25
	6797	DS-3	--	DRIVE-IN TYPE HANGER , for rectangular duct	100
	146487	BH-8	8"	DUCT HANGER , 18 gauge steel, for cold air return ducts (allows for installation flush with floor joists)	100
	146488	BH-9	9"	DUCT HANGER , 18 gauge steel, for warm air supply ducts (allows for 1" spacing below floor joists)	100
	248201	BH-10	10"	<i>Same as above</i>	100
	6804	GWS-49	9"	DUCT STRAP , galvanized, for hanging duct without use of nails, rivets, or screws	100
	6796	BH-2	5" - 6"	HOOK STRAP , galvanized, 18 gauge steel, for hanging round pipe	50
	6808	PS100-1-24C	100'	PERFORATED STRAP , <u>copper</u> , 3/4" x 24 gauge	1
	6809	PS10-10-24C	10'	<i>Same as above</i>	10
	6806	PS100-1-24G	100'	<i>Same as above</i> , but <u>galvanized</u>	1
	6807	PS10-10-24G	10'	<i>Same as above</i>	10
	718203	PS24-6-24G	25'	<i>Same as above</i>	6
	6798	PWC-6	1/2" x 6"	PIPE HANGER , 9 gauge steel, <u>copper coated</u>	50
	6799	PWC-6	3/4" x 6"	<i>Same as above</i> , but 3/4"	50
	6800	PWC-6	1" x 6"	<i>Same as above</i> , but 1"	50
	178808	PWP-4	3/4" x 4"	PIPE HANGER , 9 gauge steel, <u>plastic coated</u>	50
	6801	PWP-6	1/2" x 6"	<i>Same as above</i> , but 1/2" x 6"	50
	6802	PWP-6	3/4" x 6"	<i>Same as above</i> , but 3/4"	50
	6803	PWP-6	1" x 6"	<i>Same as above</i> , but 1"	50

FOR MORE INFORMATION, VISIT THE BASSET WEBSITE AT www.bassetproducts.com

SEPTEMBER 2024

Line #8520

BASSET HANGERS & ACCESSORIES

707.1



ID ORDER#	MODEL#	SIZE	DESCRIPTION	CTN QTY
175750	P58-16-R	5" x 8"	SAFETY PLATE , 16 gauge steel, meets BOCA code 309.2	50
445368	SSC-12	1/2"	SNAP N' SLIDE TUBING CLAMP , clamps onto bracket, then slide to proper position	50
445369	SSC-34	3/4"	Same as above	50
66228	316-503	1-1/2" x 3"	STUD GUARD , 16 gauge	100
66229	516-503	1-1/2" x 5"	Same as above	100
151519	MS-26	26"	STUB OUT BAR , 18 gauge steel, copper-plated, fits 1/2", 3/4" and 1" tubing, 1/2" hole with 3/4" and 1" knockout holes on 2" centers, reinforcing ribs for additional strength	50
224829	PS-10120R	20"	STUB OUT BAR , 16 gauge steel, copper-plated, fluted edge, 1/2" extruded holes on 2" centers	25

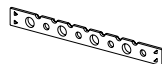
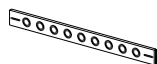

FOR MORE INFORMATION, VISIT THE BASSET WEBSITE AT www.bassetproducts.com

ID	ORDER#	MODEL#	SIZE	DESCRIPTION	CTN	QTY
----	--------	--------	------	-------------	-----	-----

* = SPECIAL ORDER ITEM

AMTROL LINE # 4400

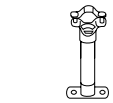

5854 *	601	1-1/2"	COPPER TUBE HANGER , designed to use 1/2" hard copper scraps to vary hanger length, sold by box quantity	10
5855 *	601	2"	<i>Same as above</i>	10



5856 *	602	1/2"	INSO-LINE STRAP HANGER , 6" long with plastic glide loop, ideal for noise isolation, sold by box quantity	25
5858 *	602	1"	<i>Same as above</i>	25
5859 *	602	1-1/4"	<i>Same as above</i>	25

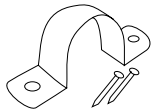

5873	608-4	1/2"	COPPER TUBE STRAP , uncoated, for nailing directly to joist, sold by box quantity	100
5874	608-6	3/4"	<i>Same as above</i>	50
5875	608-7	1"	<i>Same as above</i>	50
5876	608-8	1-1/4"	<i>Same as above</i>	50

B-LINE LINE #8600

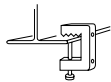

5537	BC1	--	BEAM CLAMP , very universal, fits flanges through 1/2", supports 1/4" threaded rod, conduit clips, pipe hangers, S-hooks and bridle rings; 1/4" - 20 thread impression on two faces, vibration resistant, removable and reuseable	100
------	-----	----	--	-----

Load capacities: 200 lbs. with 4:1 safety factor with set screw below flange, 100 lbs., with 4:1 safety factor with set screw above flange

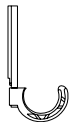

BRUCO LINE #0915

These hangers are constructed of durable plastic, hold pipes firmly in any direction — vertical, horizontal or diagonal — while allowing for expansion and contraction. Each package of hooks comes complete with 50 nails for quick and easy installation. **Sold by carton only.**



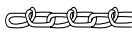

664054	20500	1/2" x 5"	"J" HOOKS—ONE-PIECE WITH PRELOADED NAILS , for both copper and CPVC water pipe, package of 25
664055	20750	3/4" x 5"	<i>Same as above</i>
664073	20100	1" x 6"	<i>Same as above</i>
25740	MH1500-9	1-1/2" x 9"	"J" MULTI-HOOKS — TWO-PIECE , for Schedule 40 PVC pipe, calibrated for 1/4" fall per foot (supported every 4 feet), rotating and locking features allow pipe to be hung on angles, package of 25
25741	MH2000-9	2" x 9"	<i>Same as above</i>
25742	MH3000-9	3" x 9"	<i>Same as above</i> , also fits 3" Schedule 30

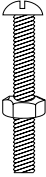
FOR ADDITIONAL INFORMATION, VISIT THE WEBSITE AT: www.brucoproducts.com

	ID ORDER#	MODEL#	SIZE	DESCRIPTION	CTN QTY
GENERAL CHAIN & MGF. CORP. LINE #8540					
	6790	#2/0	--	WELL CHAIN , twisted, weldless, galvanized, rated at 255 lb. working load (250' per carton)	250
	6791	#7	--	"S" HOOK , #7 wire gauge, bright zinc, 1-1/2" overall length	100
JONES-STEPHENS LINE #0910 					
	247087	F33-010	1/4"-20"	STOVE BOLT , 3/4", zinc-plated, full thread with hex nut	100
	247090	F33-011	1/4"-20"	Same as above, but 1"	100
	247092	F33-014	1/4"-20"	Same as above, but 2"	100
	8466	F33-080	1/4"-20"	HEX NUT , zinc-plated	100
	247296	F33-082	3/8"-16"	Same as above	100
	8468	F33-083	1/2"-13"	Same as above	50
	8529	F33-094	3/8"	FLAT WASHER , zinc-plated	100
	247091	F33-095	1/2"	Same as above	100

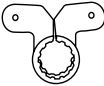
FOR ADDITIONAL INFORMATION, VISIT THEIR WEBSITE AT www.plumbest.com

	OATEY	LINE #2900			
	39128	33935	1/2"	INSULATING SUSPENSION CLAMP , for copper, CPVC and polybutylene	100
	39129	33936	3/4"	Same as above	
	39130	33937	1"	Same as above	
	39136	33940	1/2"	2-HOLE PIPE CLAMP , for copper, CPVC and polybutylene	100
	39137	33941	3/4"	Same as above	
	39138	33942	1"	Same as above	

FOR ADDITIONAL INFORMATION, VISIT THE OATEY WEBSITE AT: www.oateyscs.com

ID ORDER#	MODEL#	SIZE	DESCRIPTION	CTN QTY
<div style="display: flex; align-items: center;"> <div style="border: 1px solid black; padding: 2px; margin-right: 10px;"> SIOUX CHIEF LINE #1790 </div>  </div>				
228757	522-5501	--	BRACKET CLAMP , for #522-2420, consists of (1) bridge, (1) base, and (1) insert	100
742694	508-2PK	1/2"	CTS BELL HANGER , 22 gauge copper-plated steel	25
742696	508-3PK	3/4"	Same as above, but 3/4"	25
742697	508-4PK	1"	Same as above, but 1"	25
2685	554-100	3/4" x 100'	HANGER STRAP	1
565553	523-1620	--	PIPE BRACKET—ADJUSTABLE , for universal slider bracket system; heavy galvanized steel, for 11"-19" opening, includes (2) clamps	50
228755	523-2420	--	Same as above, but for 14"-26" opening	50
584912	502-2	1/2"	PIPE STRAP , IPS 22 gauge galvanized, 2-hole	100
584914	502-3	3/4"	Same as above, but 3/4"	100
584915	502-4	1"	Same as above, but 1"	100
584918	502-5	1-1/4"	Same as above, but 1-1/4"	50
584916	502-6	1-1/2"	Same as above, but 1-1/2"	50
584919	502-7	2"	Same as above, but 2"	50
584920	502-75	2-1/2"	Same as above, but 2-1/2"	25
584921	502-8	3"	Same as above, but 3"	25
742401	533-1	--	SHOE SUPPORT BRACKET—SINGLE STUD , 16 gauge steel	25
742402	533-2	--	Same as above, but <u>double stud</u>	25
745519	520-616	--	SUPPORT BRACKET—WIDER SLIDER , galvanized	50

WAGNER PRODUCTS CORP. LINE # 5605



10035	M-1	--	CIRCULAR TELESCOPING POCKET MIRROR , 1-1/4" in diameter that extends to 18-3/4"	1
155953	WS-1	--	WET SWITCH , 24V	1



ID	MODEL #	SIZE	DESCRIPTION
----	---------	------	-------------

BRUSHES



9945	84015	1-1/2"	BOILER FLUE BRUSH , double spiral, tempered wire (bristle)
9946	84025	2"	<i>Same as above</i>
9948	84035	2-1/2"	<i>Same as above</i>
9951	84045	3"	<i>Same as above</i>
9955	84065	4"	<i>Same as above</i>
9956	84007	1/2" x 1" x 48"	COLUMBIA BOILER FLUE BRUSH , for very narrow flue passes, with 48" flex wire handle



4510	61210	1/2" I.D.	COPPER FITTING BRUSH , heavy duty handle
4511	61330	3/4" I.D.	<i>Same as above</i>
4512	61450	1" I.D.	<i>Same as above</i>
4513	61500	1-1/4" I.D.	<i>Same as above</i>
4514	61560	1-1/2" I.D.	<i>Same as above</i>
4515	61620	2" I.D.	<i>Same as above</i>
123218	63035	1/2" I.D.	COPPER FITTING BRUSH—BLUE MONSTER PREMIUM , double-spiral straight wire high-carbon bristles, plastic handle
123220	63060	3/4" I.D.	<i>Same as above</i>

9936	70221	1/2"	#2 ACID BRUSH , 3/8" wide, for solder flux
------	-------	------	---

5246	70100	1-1/2" x 10 yards	GRIT CLOTH , premium open mesh nylon fabric with phenolic resin and aluminum oxide grains; waterproof and re-usable; lasts 10 times longer than other products
------	-------	-------------------	---

SEALANT & TEFLON TAPE

741886	70885	1/2" x 1429"	BLUE MONSTER THREAD SEALANT TAPE
741887	70886	3/4" x 1429"	<i>Same as above</i>
5232	70200	1/2" x 520"	TEFLON TAPE
28403	70196	3/4" x 520"	<i>Same as above</i>

FOR ADDITIONAL INFORMATION, VISIT THE MILL-ROSE WEBSITE AT: www.millrose.com

ID ORDER#	MODEL#	DESCRIPTION	CTN QTY
741886	70885	BLUE MONSTER THREAD SEALANT TAPE , 1/2" x 1429"	45
741887	70886	Same as above, but 3/4" x 1429"	27
155106	6-330	CORK INSULATION TAPE , 2" x 30'	12
5248	1086188	DUCT TAPE , silver, 2" x 180'	24
153810	N-398-B	Same as above, but black, 2" x 180'	24
196124	P-557 (557000A)	DUCT TAPE - UL 181 APPROVED , silver, 2" x 180'	24
44320	IDT-490-3X117 (490)	DUCTBOARD TAPE , heat seal, 2 MIL aluminum foil iron-on type, approved under UL181-A specs, temperature range of -20°F to 250°F, 3" x 117 yards (351 feet)	16
5539	P-338	DUCTBOARD TAPE , self-adhering, FSK reinforced (scrim), specially-designed for reinforcing under tri-directional strain, 3" x 150'	16
27450	P-339 (1087636)	DUCTBOARD TAPE , self-adhering, foil type, for duct foil wrap or ductboard, used in exposed applications, 2-1/2" x 180', UL 181 approved, 325°F maximum temperature	16
445730	ET33	ELECTRICAL TAPE , 3M premium grade, 3/4" x 66', 7 mil thick, all-weather vinyl, resealable plastic case not suitable for more than 600 volts or 176°F	10
86742	10298	FIBERGLASS TAPE , 3" x 150', for pipe insulation	16
155107	6-9718	FOAM INSULATION TAPE , 1/8" x 2" x 30'	12
740341	1087392 444B (LS300)	LINESET TAPE , 2" x 180', black printed, UV resistant	12
6126	P-827 (1086543)	PCD VINYL TAPE , 2" x 108'	24
5232	70200	TEFLON TAPE , 1/2" x 520"	10
28403	70196	Same as above, but 3/4" x 520"	6

ID
ORDER# MODEL# DESCRIPTION

DWYER INSTRUMENTS LINE #8090

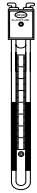

6812 1227

DUAL RANGE FLEX-TUBE "U" INCLINED MANOMETER, ideal for service, offering single direct readings in 2 ranges. As a U-tube, it reads 0-16" of water; as an inclined gauge, it reads from .20 to 0 to 2.6" of water. Uses .826 specific gravity red gauge fluid, a "must" for pressure switch and measuring venting pressures of condensing furnaces and boilers

Kit consists of: manometer, (1) 4-1/2' length plastic tubing, (2) plastic carrying plugs, (2) magnetic clips, flexible red vinyl plastic tubing connectors, 1/4"D x 8"L brass terminal tube, (1) terminal tube holder, brass adapter (1/8" pipe thread to plastic tubing), (1) 3/4 oz. bottle red gauge fluid, vinyl carrying case

11673 A101

RED GAUGE OIL, for #1227 incline manometer, special .826 specific gravity, 3/4 oz. dispenser bottle

RICHARD SPECIALTY COMPANY LINE #8370

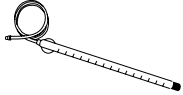

4428 R408300

HYDRO-GAUGE, 15" WATER COLUMN, includes magnetic clip, plastic hose and adapter, used for measuring LP and natural gas pressure

800 SECTION

Design & Engineering

800 SECTION INDEX

BTU & Orifice Size Guide	905
Engineering & Sizing Data	907
Extended Plenum Air Distribution System	900
Gas Orifice Flow Rates	904
Natural Gas Line Sizing	902
Pipe Dimensions & Capacities	906
Propane (LP) Gas Line Sizing	903
Round Duct Supply/Return System	901
Water Heating Calculations	908

TYPICAL EXTENDED PLENUM AIR DISTRIBUTION SYSTEM (using Seal-Tite fittings and numbers)

800

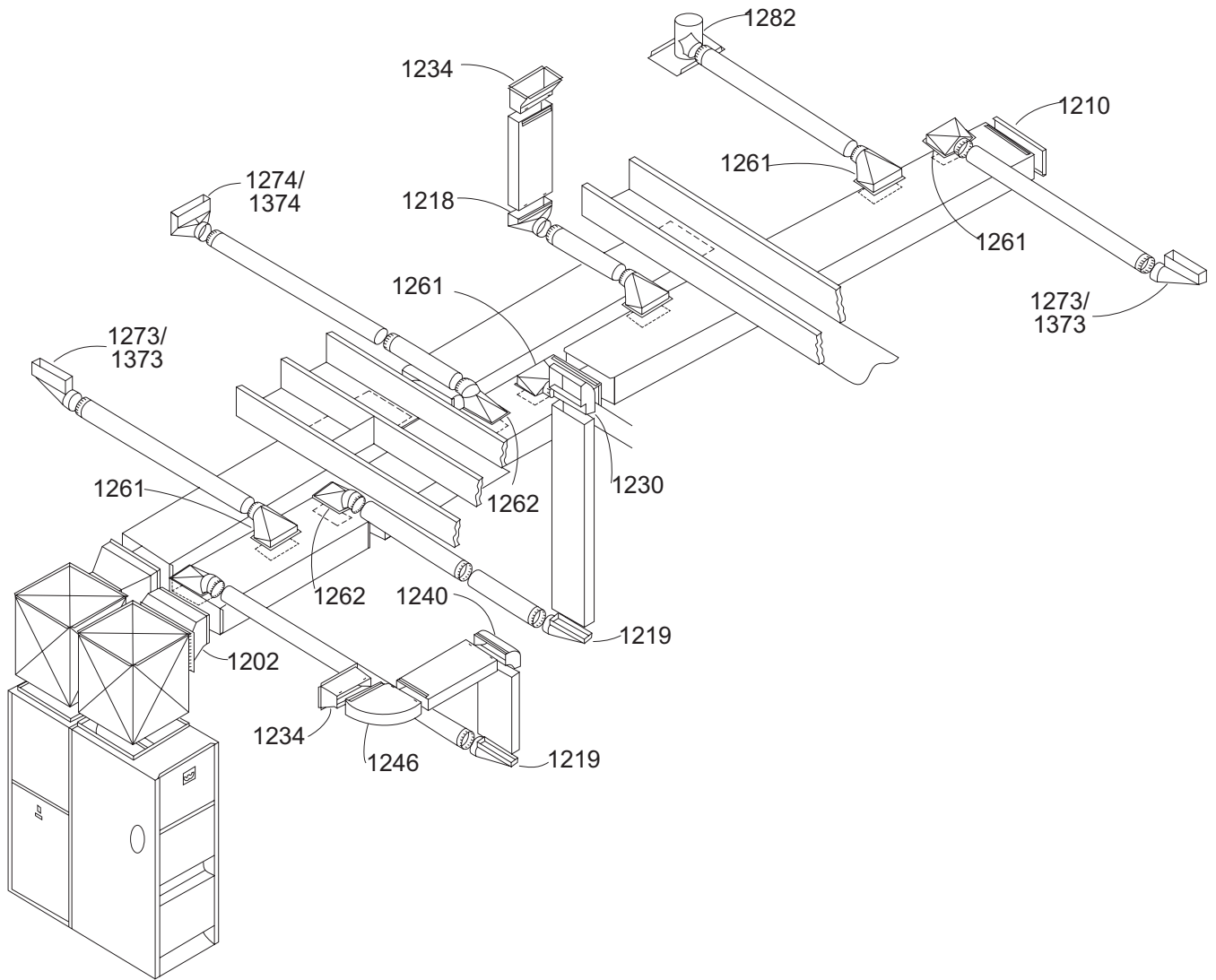

ROUND DUCT SUPPLY/RETURN SYSTEM (using Seal-Tite fittings and numbers)

801

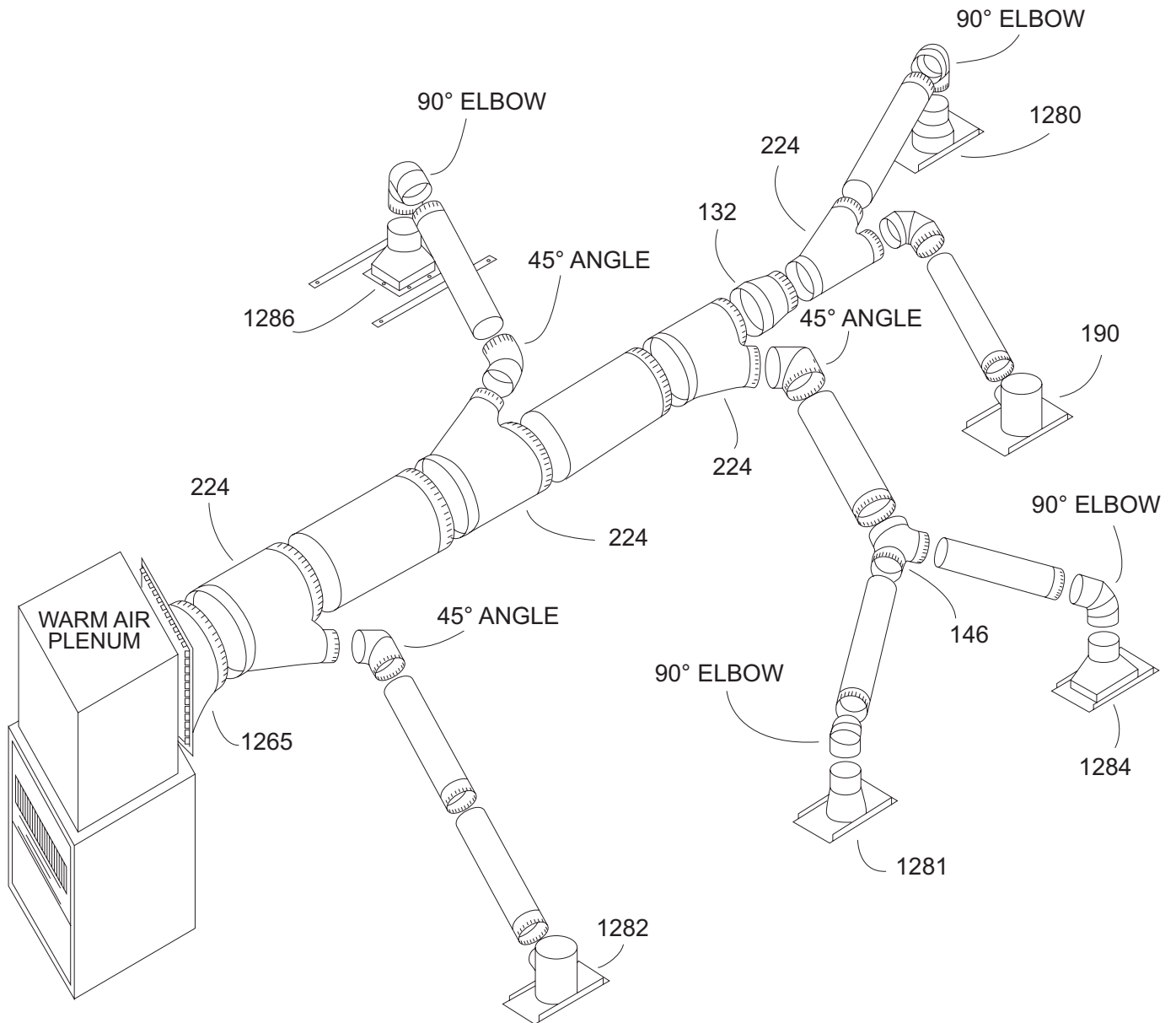

NATURAL GAS LINE SIZING

FLOW CAPACITY: SCHEDULE 40 STEEL PIPE, 0.6 SPECIFIC GRAVITY, 1000 BTU/CF NATURAL GAS

Length in Feet	Pressure Drop in Water	For pressure under 1 lb (based on 3.5" w.c.)									
		Nominal Iron Pipe Size									
		1/2"	3/4"	1"	1-1/4"	1-1/2"	2"	2-1/2"	3"	4"	5"
10	0.3	132	278	520	1,050	1,600	3,050	4,800	8,500	17,500	--
10	0.5	175	360	680	1,400	2,100	6,950	6,300	11,000	23,000	--
20	0.3	92	190	350	730	1,100	2,100	3,300	5,900	12,000	--
20	0.5	120	250	465	950	1,460	2,750	4,350	7,700	15,800	--
30	0.3	73	152	285	590	890	1,650	2,700	4,700	9,700	--
30	0.5	97	200	375	770	1,180	2,200	3,520	6,250	12,800	--
40	0.3	63	160	245	500	760	1,450	2,300	4,100	8,300	--
40	0.5	82	170	320	660	990	1,900	3,000	5,300	10,900	--
50	0.3	56	115	215	440	670	1,270	2,000	3,600	7,400	24,134
50	0.5	73	151	285	580	900	1,680	2,650	4,750	9,700	31,140
60	0.3	50	105	195	400	610	1,150	1,850	3,250	6,800	--
60	0.5	66	138	260	530	810	1,520	2,400	4,300	8,800	--
70	0.3	46	96	180	370	560	1,050	1,700	3,000	6,200	--
70	0.5	61	125	240	490	750	1,400	2,250	3,900	8,100	--
80	0.3	43	90	170	350	530	990	1,600	2,800	5,800	--
80	0.5	57	118	220	460	690	1,300	2,050	3,700	7,500	--
90	0.3	40	84	160	320	490	930	1,500	2,600	5,400	--
90	0.5	53	110	205	430	650	1,220	1,950	3,450	7,200	--
100	0.3	38	79	150	305	460	870	1,400	2,500	5,100	17,019
100	0.5	50	103	195	400	620	1,150	1,850	3,250	6,700	21,960
125	0.3	34	72	130	275	410	780	1,250	2,200	4,500	--
125	0.5	44	93	175	360	550	1,020	1,650	2,950	6,000	--
150	0.3	31	64	120	250	380	710	1,130	2,000	4,100	13,842
150	0.5	40	84	160	325	500	950	1,500	2,650	5,500	17,860
175	0.3	28	59	110	225	350	650	1,050	1,850	3,800	--
175	0.5	37	77	145	300	460	850	1,370	2,450	5,000	--
200	0.3	26	55	100	210	320	610	980	1,700	3,500	11,873
200	0.5	35	72	135	280	430	800	1,280	2,280	4,600	15,320
250	0.3	--	--	84	186	288	582	955	1,739	3,596	10,664
250	0.5	--	--	109	240	372	751	1,232	2,244	4,640	13,760
300	0.3	--	--	77	170	263	531	870	1,586	3,472	9,688
300	0.5	--	--	99	219	339	685	1,123	2,047	4,480	12,500
400	0.3	--	--	67	146	228	398	755	1,375	2,837	8,417
400	0.5	--	--	86	189	294	514	974	1,774	3,660	10,860
500	0.3	--	--	60	131	204	412	673	1,230	2,589	7,665
500	0.5	--	--	77	169	263	530	869	1,587	3,340	9,890
For pressure of 1 lb. with 10% pressure drop											
50	--	--	--	740	1,540	2,330	4,550	7,330	13,100	26,980	80,560
100	--	--	--	520	1,090	1,650	3,210	5,180	9,260	19,070	56,940
150	--	--	--	430	890	1,350	2,640	4,250	7,600	15,650	46,740
200	--	--	--	370	760	1,160	2,260	3,650	6,520	13,430	40,090
300	--	--	--	300	630	960	1,870	3,020	5,400	11,120	33,210
400	--	--	--	260	540	830	1,610	2,600	4,660	9,590	28,650
500	--	--	--	230	490	740	1,440	2,320	4,160	8,560	25,580

CONVERSION FACTORS

(for use with the table at the left)

Specific Gravity Multiplier

Natural Gas

0.50	1.10
0.55	1.04
0.60	1.00
0.65	0.962
0.70	0.926
0.75	0.895
0.80	0.867
0.85	0.841
0.90	0.817
1.00	0.775

Propane—Air

1.10*	0.740
1.20	0.707
1.30	0.680
1.40	0.655
1.50	0.632

Propane

1.55*	0.622
1.60	0.612
1.70	0.594
1.80	0.577
1.90	0.565

Butane

2.00*	0.547
-------	-------

Pressure Drop Multiplier

0.1	0.577
0.2	0.815
0.3	1.00
0.5	1.29
1.0	1.83
2.0	2.58
3.0	3.16
4.0	3.65

* These are the normal specific gravity values recommended.

PROPANE (LP) GAS LINE SIZING

803

TABLE 2 — Sizing between single or 2nd stage regulator and appliance*

Maximum propane capacities listed based on 2 psig pressure drop @ 10 psig setting — capacities in 1000 BTU/hr.

PIPE OR TUBING LENGTH (FEET)	TUBING SIZE, O.D., TYPE L						NOMINAL PIPE SIZE, SCHEDULE 40									
	3/8"	1/2"	5/8"	3/4"	7/8"	1-1/8"	1/2"	3/4"	1"	1-1/4"	1-1/2"	2"	2-1/2"	3"	4"	
10	39	92	199	329	501	935	275	567	1,071	2,205	3,307	6,221	10,140	17,990	36,710	
20	26	62	131	216	346	630	189	393	732	1,496	2,299	4,331	7,046	12,510	25,520	
30	21	50	107	181	277	500	152	315	590	1,212	1,858	3,465	5,695	10,110	20,620	
40	19	41	90	145	233	427	129	267	504	1,039	1,559	2,992	4,778	8,481	17,300	
50	18	37	79	131	198	376	114	237	448	913	1,417	2,646	4,343	7,708	15,730	
60	16	35	72	121	187	340	103	217	409	834	1,275	2,394	3,908	6,936	14,150	
80	13	29	62	104	155	289	89	185	346	724	1,086	2,047	3,329	5,908	12,050	
100	11	26	55	90	138	255	78	162	307	630	976	1,811	2,991	5,309	10,830	
125	10	24	48	80	122	224	69	146	275	567	866	1,606	2,654	4,711	9,613	
150	9	21	43	72	109	202	63	132	252	511	787	1,496	2,412	4,281	8,736	
200	8	19	39	66	100	187	54	112	209	439	665	1,282	2,038	3,618	7,382	
250	8	17	36	60	93	172	48	100	185	390	590	1,138	1,808	3,210	6,549	
300	--	--	--	--	--	--	43	90	168	353	534	1,050	1,637	2,905	5,927	
350	--	--	--	--	--	--	40	83	155	325	491	947	1,505	2,671	5,450	
400	--	--	--	--	--	--	37	77	144	303	458	883	1,404	2,492	5,084	

* Data in accordance with NFPA Pamphlet No. 54.

NOTE:

Determine distance from regulator to the furthest appliance. Use this distance in selecting each section of pipe or tubing. Method in accordance with NFPA Pamphlet #54-1969.

GAS ORIFICE FLOW RATES FOR PILOT AND MAIN GAS BURNERS

ORIFICE DIAMETER (inches)	NATURAL GAS FLOW (BTU/hr)* 3.5" W.C. PRESSURE	LPG (PROPANE) FLOW (BTU/HR)** 11.0" W.C. PRESSURE				
.010	250	720				
.012	355	1020				
.014	480	1380				
.0156 (1/64)	565	1620				
.018	790	2270				
.020	980	2810				
.022	1225	3515				
.024	1437	4125				
.026	1690	4850				
.028	1960	5625				
.029	2247	6450				
.0312 (1/32)	2433	6980				
.033	2720	7810				
.035	3060	8780				
.037	3418	9810				
.039	3800	10,900				
.041	4200	12,000				
.043	4620	13,300				
.0469 (3/64)	5500	15,800				
.052	6740	19,300				
.055	7565	21,700				
.0595	8980	25,800				
.0625 (1/16)	9765	28,000				
.0635	10,100	29,000				
.067	11,200	32,100				
.070	12,200	35,200				
.073	13,300	38,200				
.076	14,400	41,300				
.0781 (5/64)	15,200	43,600				
.082	16,800	48,200				
.086	18,500	53,100				
.089	19,800	56,800				
.0937 (3/32)	21,900	62,800				
.096	23,000	66,000				
.098	24,000	68,900				
.0995	24,700	70,900				
.1015	25,700	73,800				
.104	27,000	77,500				
.1065	28,300	81,200				
.1094 (7/64)	29,900	85,800				
.113	31,900	91,600				
*Natural gas of 0.64 specific gravity, 1000 BTU/cu ft. To adjust for orifice pressures other than 3.5" w.c., multiply by these factors:						
Orifice Pressure (in.w.c.)	2.0	2.5	3.0	3.5	4.0	5.0
Multiply by	.76	.85	.93	1.00	1.07	1.19

ORIFICE DIAMETER (inches)	NATURAL GAS FLOW (BTU/hr)* 3.5" W.C. PRESSURE	LPG (PROPANE) FLOW (BTU/HR)** 11.0" W.C. PRESSURE				
.116	33,600	96,400				
.120	35,900	103,000				
.125 (1/8)	39,000	112,000				
.1235	41,200	118,000				
.136	46,200	133,000				
.1406 (9/64)	49,400	142,000				
.144	51,800	149,000				
.147	54,000	155,000				
.1495	55,800	160,000				
.152	57,700	166,000				
.154	59,200	170,000				
.1562 (5/32)	60,900	175,000				
.159	63,200	181,000				
.161	64,800	186,000				
.166	68,800	197,000				
.1695	71,800	206,000				
.1719 (11/64)	73,800	212,000				
.173	74,800	215,000				
.177	78,300	225,000				
.180	80,900	232,000				
.182	82,700	237,000				
.185	84,900	246,000				
.1875 (3/16)	87,800	252,000				
.189	89,300	256,000				
.191	91,100	261,000				
.1935	93,500	268,000				
.196	95,900	275,000				
.199	98,800	284,000				
.201	101,000	290,000				
.2031 (13/64)	103,000	296,000				
.2055	105,500	303,000				
.209	109,000	313,000				
.213	113,000	325,000				
.2187 (7/32)	119,500	343,000				
.221	122,000	350,000				
.228	130,000	373,000				
.2344 (15/64)	137,000	393,000				
.238	142,000	408,000				
.242	146,000	419,000				
.246	151,000	433,000				
.250 (1/4)	156,000	448,000				
** LP gas (propane) of 1.53 specific gravity, 2500 BTU/cu ft. To adjust for orifice pressures other than 11" w.c., multiply by these factors:						
Orifice Pressure (in.w.c.)	7.0	8.0	9.0	10.0	11.0	12.0
Multiply by	.80	.85	.90	.95	1.0	1.04

FOR A BTU AND ORIFICE SIZING GUIDE BASED ON DRILL SIZES, SEE PAGE 905

BTU & ORIFICE SIZE GUIDE BASED ON DRILL SIZES

DRILL SIZES						
BTU INPUT	NATURAL GAS					LP GAS 1 1/2" WC
	3" WC	3.5" WC	4" WC	4.5" WC	7" WC	
10,000	51	52	1/16	53	54	62
12,000	50	50	51	51	53	59
14,000	48	49	50	50	52	57
16,000	46	5/64	48	49	51	56
18,000	45	46	47	48	50	55
20,000	44	44	45	46	49	54
25,000	3/32	42	43	44	46	53
30,000	38	40	41	42	44	52
35,000	35	35	48	39	42	50
40,000	31	33	35	36	41	48
45,000	30	1/8	32	33	38	47
50,000	29	30	1/8	31	36	46
55,000	28	29	30	30	34	44
60,000	26	28	29	30	31	44
65,000	24	26	28	29	1/8	43
70,000	22	24	26	28	30	42
75,000	20	5/32	24	26	30	3/32
80,000	18	20	22	24	29	40
85,000	17	19	20	5/32	28	39
90,000	15	17	19	20	27	38
95,000	13	16	11/64	19	25	36
100,000	11	14	16	18	24	7/64
105,000	9	3/16	15	16	5/32	34
110,000	7	10	13	15	21	33
115,000	6	9	11	14	19	32
120,000	4	7	9	3/16	18	31
125,000	3	5	8	10	11/64	1/8
130,000	7/32	4	13/64	9	16	1/8
140,000	#1	7/32	3	6	14	30
150,000	15/16	#1	7/32	3	3/16	29
175,000	1/4	C	15/64	#1	6	27
200,000	H	F	1/4	C	7/32	23
225,000	L	J	17/64	F	A	19
250,000	N	L	K	I	C	17
275,000	O	N	M	9/32	F	14
300,000	21/64	O	N	19/64	H	10
340,000		U				3
400,000		Y				15/64
440,000		13/32				C
500,000		7/16				F
600,000		31/64				M
700,000		33/64				15/16
800,000		9/16				R
900,000		19/32				T
1,000,000		41/64				W
K FACTOR= 0.82	Calculations based on natural-1050 BTU gas @ 0.065 specific gravity and LP 2500 BTU gas @ 1.59 specific gravity. Approximate sizes based on average data for all orifice types.					

DIMENSIONS & CAPACITIES OF TYPE "L" COPPER TUBING

NOMINAL SIZE (inches)	OUTSIDE DIAMETER (inches)	INSIDE DIAMETER (inches)	U.S. GALLONS (in 100')	WEIGHT OF PIPE (lbs/ft.)
1/8	0.250	0.200	0.163	0.068
1/4	0.375	0.315	0.405	0.126
3/8	0.500	0.430	0.754	0.198
1/2	0.625	0.545	1.21	0.284
5/8	0.750	0.666	1.81	0.362
3/4	0.875	0.785	2.51	0.454
1	1.25	1.025	4.28	0.653
1-1/4	1.375	1.265	6.52	0.884
1-1/2	1.625	1.505	9.25	1.14
2	2.125	1.985	16.06	1.75
2-1/2	2.625	2.465	24.78	2.48
3	3.125	2.945	35.37	3.33
3-1/2	3.625	3.425	47.86	4.29
4	4.125	3.905	62.18	5.38

DIMENSIONS & CAPACITIES OF STANDARD STEEL PIPE

NOMINAL SIZE (inches)	OUTSIDE DIAMETER (inches)	INSIDE DIAMETER (inches)	U.S. GALLONS (in 100')	WEIGHT OF PIPE (lbs/ft.)
1/8	0.405	0.269	0.3	0.244
1/4	0.540	0.364	0.5	0.424
3/8	0.675	0.493	1.0	0.567
1/2	0.840	0.622	1.6	0.850
3/4	1.050	0.824	2.8	1.130
1	1.315	1.049	4.5	1.678
1-1/4	1.660	1.380	6.3	2.28
1-1/2	1.900	1.610	10.2	2.72
2	2.375	2.067	17.0	3.66
2-1/2	2.875	2.469	27.5	5.80
3	3.50	3.068	39.0	7.58
3-1/2	4.00	3.548	53.0	9.11
4	4.50	4.026	69.0	10.8

DIMENSIONS OF SCHEDULE 30 & 40 PVC PLASTIC PIPE

#600 Schedule 30 Pipe

#700 Schedule 40 Pipe

NOMINAL SIZE (inches)	OUTSIDE DIAMETER (inches)	INSIDE DIAMETER (inches)	NOMINAL SIZE (inches)	OUTSIDE DIAMETER (inches)	INSIDE DIAMETER (inches)
3	3.255*	3	1-1/2	1.90	1-1/2
			2	2.375	2
			3	3.50	3
			4	4.50	4
			6	6.625	6

* approximate value

NOTES REGARDING ANTI-FREEZE SOLUTION IN HEATING BOILERS:

1. Use only a permanent type with propylene glycol base.
2. For best protection, use the following solutions:

Lowest Outdoor Temperature	Percentage Anti-Freeze
+20°F	17%
+10°F	25%
0°F	33%
-10°F	39%
-20°F	44%
-30°F	49%

CAPACITIES OF CYLINDRICAL TANKS IN U.S. GALLONS

LENGTH (FEET)	DIAMETER IN INCHES																
	12"	18"	24"	30"	36"	42"	48"	54"	60"	66"	72"	78"	84"	90"	98"	102"	108"
1	6	13	24	37	53	72	94	120	145	180	210	250	290	330	375	425	475
2	12	26	48	74	106	144	188	240	290	360	420	500	580	660	750	850	950
3	18	39	72	111	159	216	282	360	435	540	630	750	870	990	1125	1275	1425
4	24	52	96	148	212	288	376	480	580	720	840	1000	1160	1320	1500	1700	1900
5	30	65	120	185	265	360	470	600	725	900	1050	1250	1450	1650	1875	2125	2375
6	36	78	144	222	318	432	564	720	870	1080	1260	1500	1740	1980	2250	2550	2850
7	42	91	168	259	371	504	658	840	1015	1260	1470	1750	2030	2310	2625	2975	3325
8	48	104	192	296	424	576	752	960	1160	1440	1680	2000	2320	2640	3000	3400	3800
9	54	117	216	333	477	648	846	1080	1305	1620	1890	2250	2610	1970	3375	3825	4275
10	60	130	240	370	530	720	940	1200	1540	1800	2100	2500	2900	3300	3750	4250	4750
11	66	143	264	407	583	792	1034	1320	1595	1980	2310	2750	3190	3630	4125	4675	5225
12	72	156	288	444	636	864	1128	1440	1740	2160	2520	3000	3480	3960	4500	5100	5700
13	78	169	312	481	689	936	1222	1560	1885	2340	2730	3250	3770	4290	4875	5525	6175
14	84	182	336	518	742	1008	1316	1680	2030	2520	2940	3500	4060	4620	5250	5950	6650
15	90	195	360	555	795	1080	1410	1800	2175	2700	3150	3750	4350	4950	5625	6375	7125
16	96	208	384	592	848	1152	1504	1920	2320	2880	3360	4000	4640	5280	6000	6800	7600

To find the capacity of rectangular tanks, reduce all dimensions to inches, then multiply length x width x height and divide the product by 231.

WATER EQUIVALENTS

1 U.S. GALLON =	1 CUBIC FOOT =	1 CUBIC METER =
0.1337 cubic feet	7.48 U.S. gallons	1000.0 litres
231.0 cubic inches	62.33 pounds	264.2 U.S. gallons
0.833 British imp. gallons		220.0 British imp. gallons
3.785 litres		35.31 cubic feet
3785.0 cubic centimeters		
8.33 pounds		

PRESSURE ON CLOSED SYSTEM (per degrees temperature rise)

TEMPERATURE (°F)	PRESSURE RISE (LBS.)
0	0
10	2
20	3
30	4
40	6
50	10
60	16
70	30
80	95

HEAT CHANGES THE BEHAVIOR OF WATER

When heat is applied, the nature and behavior of water tends to change. As water is heated, it immediately starts to expand.

As long as the service pipe between the street main and water heater remains unobstructed to reverse flow, the water will move as it expands back toward the street main with no measurable increase in pressure.

However, should the flow in the service line be limited to flow only toward the service outlets by use of a check valve or reducing valve, (figure 1) or should a manually-operated valve be closed, water, as it expands while heating, cannot escape from the system and a damaging pressure could quickly follow.

Water, unlike air, cannot be compressed appreciably. The confinement of water results in what is called a "closed system."

Water expands at a rate of approximately 0.00023% for each degree of temperature rise. If all of the water in a 30 gallon heater were raised from 60°F to 140°F, a temperature rise of 80°F, it would increase the original volume to 30.55 gallons, an increase of .55 gallons.

Water confined in a storage tank or piping system will, when subjected to a temperature rise of 20°F (increasing from 70°F to 90°F), increase pressure from 30 lbs. up to 160 lbs.

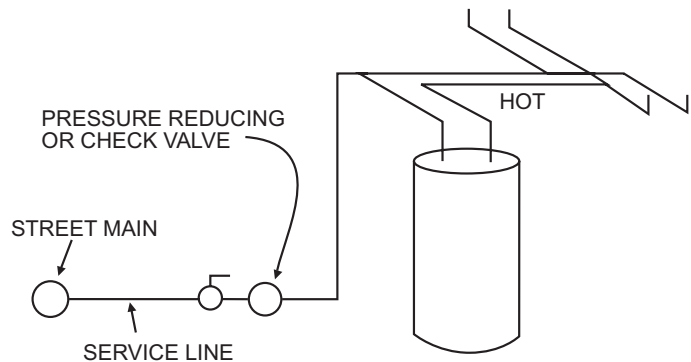

FIGURE 1: CLOSED MAIN SYSTEM

EXPLANATION OF CONSTANTS: Specific heat of water = 1.0 Pounds per gallon of water = 8.33

WATER HEATING FORMULAS

<p>% Efficiency = $\frac{\text{GPH} \times 8.33 \times \text{temperature rise} \times 1.0}{\text{BTU/Hr Input}}$</p> <p>BTU/Output = $\text{GPH} \times 8.33 \times \text{temperature rise} \times 1.0$</p> <p>BTU/Input = $\frac{\text{GPH} \times 8.33 \times \text{temperature rise} \times 1.0}{\text{BTU/Hr Output}}$</p> <p>Gallons/Hour = $\frac{\text{BTU/Hr input} \times \% \text{ efficiency}}{\text{temperature rise} \times 8.33}$</p> <p>Rise (°F) = $\frac{\text{BTU/Hr input} \times \% \text{ efficiency}}{\text{temperature rise} \times 8.33}$</p> <p>KW = $\frac{\text{GPH} \times 8.33 \times \text{temperature rise} \times 1.0}{3413}$</p> <p style="text-align: center;"><i>or</i></p> <p>$\frac{\text{GPH} \times \text{temperature rise}}{410}$</p>	<p>Gallons/Hour = $\frac{\text{KW} \times 3413}{\text{temperature rise} \times 8.33}$</p> <p style="text-align: center;"><i>or</i></p> <p>$\frac{\text{KW} \times 410}{\text{temperature rise}}$</p> <p>Rise (°F) = $\frac{\text{KW} \times 3413}{\text{GPH} \times 8.33}$</p> <p style="text-align: center;"><i>or</i></p> <p>$\frac{\text{KW} \times 410}{\text{GPH}}$</p> <p>1 KW = 3413 BTU = 4.1 gallons @ 100°F rise</p> <p>1 KW = 1000 watts (watts = BTU x 0.293)</p>
--	---

WATER MIXING FORMULAS

To determine the percentage of hot water of total mixed water requirements:	
$\frac{\text{M-C}}{\text{H-C}} = \frac{140 - 40}{180 - 40} = \frac{100}{140} = 71.5\%$	of mixture is hot water
To determine the percentage of cold water of total mixed water requirements:	
$\frac{\text{H-M}}{\text{H-C}} = \frac{180 - 140}{180 - 40} = \frac{40}{140} = 28.5\%$	of mixture is cold water

ELECTRICAL FORMULAS

$\text{Amps (1}\Phi) = \frac{\text{Watts}}{\text{Volts}}$	(Watts = volts x amps)
$\text{Amps (3}\Phi) = \frac{.577 \times \text{Watts}}{\text{Volts}}$	(Watts = volts x amps x 1.73)

PERCENTAGE OF 180°F PREHEATED WATER TO MIXING VALVE FOR SELECTED MIXED WATER TEMPERATURES

DESIRED MIX TEMPERATURE	COLD SUPPLY WATER TEMPERATURE						
	40°F	50°F	60°F	70°F	80°F	90°F	100°F
180°F	--	--	--	--	--	--	--
170°F	92.8	92.3	91.7	90.9	90	88.8	87.5
160°F	86	85	83.03	82	80	78	75
150°F	78.5	76	75	73	70	67	68.5
140°F	71	69	67	64	60	55.5	50
130°F	65	61.5	58	54.5	50	44	37.5
120°F	57	54	50	45	40	33	25
110°F	50	46	41.5	36	30	21	12
100°F	43	38	33	27	20	11	--

EXAMPLE:

- 1) Desired mixed outlet water temperature = 140°F, 71% of hot water @ 180°F
- 2) Hot water supply stored water temperature = 180°F, 29% of cold water @ 40°F
- 3) Cold water supply = 40°F, 100% mixed water @ 140°F